

Suggested Price \$1.50

# RCA

## Transistor Manual

INCLUDING RECTIFIERS, SILICON CONTROLLED RECTIFIERS,  
VARACTOR DIODES, AND TUNNEL DIODES



RADIO CORPORATION OF AMERICA  
ELECTRONIC COMPONENTS AND DEVICES, HARRISON, N. J.

Technical Series SC-11

# CONTENTS

<b>MATERIALS, JUNCTIONS, AND DEVICES</b> .....	<b>3</b>
Semiconductor Materials, P-N Junctions, Current Flow, N-P-N and P-N-P Structures, Types of Devices	
<b>TRANSISTOR DESIGNS AND CIRCUIT CONFIGURATIONS</b> .....	<b>10</b>
Design and Fabrication, Basic Circuits	
<b>TRANSISTOR CHARACTERISTICS</b> .....	<b>14</b>
<b>TRANSISTOR APPLICATIONS</b> .....	<b>18</b>
Biasing, Coupling, Circuit Stability, Amplification, Oscillation, Switching	
<b>SILICON RECTIFIERS</b> .....	<b>49</b>
Thermal Considerations, Reverse Characteristics, Ratings, Heat Sinks, Series and Parallel Arrangements, Overload Protection, Applications	
<b>SILICON CONTROLLED RECTIFIERS</b> .....	<b>59</b>
Construction, Current-Voltage Characteristics, Maximum Ratings, Triggering Characteristics, Overload Protection, Series Arrangement, Power Control, Current Ratios	
<b>TUNNEL, VARACTOR, AND OTHER DIODES</b> .....	<b>68</b>
Tunnel Diodes, High-Current Tunnel Diodes, Varactor Diodes, Voltage-Reference Diodes, Compensating Diodes	
<b>TRANSISTOR INSTALLATION</b> .....	<b>76</b>
Electrical Connections, Testing, Temperature Effects, Heat Sinks, Shielding, Dress of Circuit Leads, Filters	
<b>INTERPRETATION OF DATA</b> .....	<b>79</b>
<b>SELECTION CHARTS</b> .....	<b>82</b>
<b>TECHNICAL DATA</b> .....	<b>87</b>
<b>OUTLINES</b> .....	<b>332</b>
<b>CIRCUITS</b> .....	<b>342</b>
<b>RCA TECHNICAL PUBLICATIONS</b> .....	<b>378</b>
<b>READING LIST</b> .....	<b>381</b>
<b>INDEX</b> .....	<b>382</b>

# RCA Transistor Manual

**T**his manual, like its preceding edition, has been prepared to assist those who work or experiment with semiconductor devices and circuits. It will be useful to engineers, educators, students, radio amateurs, hobbyists, and others technically interested in transistors, silicon rectifiers, silicon controlled rectifiers, varactor diodes, and tunnel diodes.

**T**his edition has been thoroughly revised to cover the latest changes in semiconductor-device technology and applications. The TECHNICAL DATA Section, as well as the text material, has been greatly expanded and brought up to date. Of particular interest to the hobbyist and experimenter are the many practical and timely additions to the CIRCUITS Section.

**RADIO CORPORATION OF AMERICA**

**Electronic Components and Devices  
Harrison, New Jersey**

INFORMATION FURNISHED BY RCA IS BELIEVED TO BE ACCURATE AND RELIABLE. HOWEVER, NO RESPONSIBILITY IS ASSUMED BY RCA FOR ITS USE; NOR FOR ANY INFRINGEMENTS OF PATENTS OR OTHER RIGHTS OF THIRD PARTIES WHICH MAY RESULT FROM ITS USE. NO LICENSE IS GRANTED BY IMPLICATION OR OTHERWISE UNDER ANY PATENT OR PATENT RIGHTS OF RCA.

Copyright 1964 by

**RADIO CORPORATION OF AMERICA**

(All rights reserved)



Trade Mark(s) Registered  
Marca(s) Registrada(s)

6-64  
Printed in U.S.A.



# Materials, Junctions, and Devices

**S**EMICONDUCTOR devices are small but versatile units that can perform an amazing variety of control functions in electronic equipment. Like other electron devices, they have the ability to control almost instantly the movement of charges of electricity. They are used as rectifiers, detectors, amplifiers, oscillators, electronic switches, mixers, and modulators.

In addition, semiconductor devices have many important advantages over other types of electron devices. They are very small and light in weight (some are less than an inch long and weigh just a fraction of an ounce). They have no filaments or heaters, and therefore require no heating power or warm-up time. They consume very little power. They are solid in construction, extremely rugged, free from microphonics, and can be made impervious to many severe environmental conditions. The circuits required for their operation are usually simple.

## SEMICONDUCTOR MATERIALS

Unlike other electron devices, which depend for their functioning on the flow of electric charges through a vacuum or a gas, semiconductor devices make use of the flow of current in a solid. In general, all materials may be classified in three major categories—conductors, semiconductors, and insulators—depending upon their ability to conduct an electric current. As the name indicates, a semiconductor material has poorer

conductivity than a conductor, but better conductivity than an insulator.

The materials most often used in semiconductor devices are germanium and silicon. Germanium has higher electrical conductivity (less resistance to current flow) than silicon, and is used in most low- and medium-power diodes and transistors. Silicon is more suitable for high-power devices than germanium because it can be used at much higher temperatures. A relatively new material which combines the principal desirable features of both germanium and silicon is gallium arsenide. When further experience with this material has been obtained, it is expected to find much wider use in semiconductor devices.

### Resistivity

The ability of a material to conduct current (conductivity) is directly proportional to the number of free (loosely held) electrons in the material. Good conductors, such as silver, copper, and aluminum, have large numbers of free electrons; their resistivities are of the order of a few millionths of an ohm-centimeter. Insulators such as glass, rubber, and mica, which have very few loosely held electrons, have resistivities as high as several million ohm-centimeters.

Semiconductor materials lie in the range between these two extremes, as shown in Fig. 1. Pure germanium has a resistivity of 60 ohm-centimeters. Pure silicon has a considerably higher resistivity, in the order

of 60,000 ohm-centimeters. As used in semiconductor devices, however, these materials contain carefully controlled amounts of certain impurities

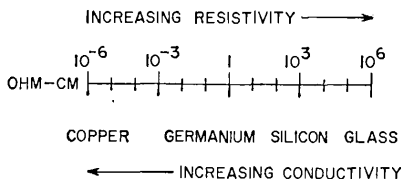

Figure 1. Resistivity of typical conductor, semiconductors, and insulator.

which reduce their resistivity to about 2 ohm-centimeters at room temperature (this resistivity decreases rapidly as the temperature rises).

### Impurities

Carefully prepared semiconductor materials have a crystal structure. In this type of structure, which is called a lattice, the outer or valence electrons of individual atoms are tightly bound to the electrons of adjacent atoms in electron-pair bonds, as shown in Fig. 2. Because such a

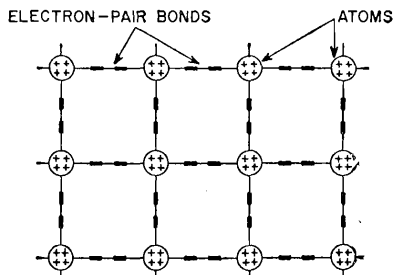

Figure 2. Crystal lattice structure.

structure has no loosely held electrons, semiconductor materials are poor conductors under normal conditions. In order to separate the electron-pair bonds and provide free electrons for electrical conduction, it would be necessary to apply high temperatures or strong electric fields.

Another way to alter the lattice structure and thereby obtain free electrons, however, is to add small

amounts of other elements having a different atomic structure. By the addition of almost infinitesimal amounts of such other elements, called "impurities", the basic electrical properties of pure semiconductor materials can be modified and controlled. The ratio of impurity to the semiconductor material is usually extremely small, in the order of one part in ten million.

When the impurity elements are added to the semiconductor material, impurity atoms take the place of semiconductor atoms in the lattice structure. If the impurity atoms added have the same number of valence electrons as the atoms of the original semiconductor material, they fit neatly into the lattice, forming the required number of electron-pair bonds with semiconductor atoms. In this case, the electrical properties of the material are essentially unchanged.

When the impurity atom has one more valence electron than the semiconductor atom, however, this extra electron cannot form an electron-pair bond because no adjacent valence electron is available. The excess electron is then held very loosely by the atom, as shown in Fig. 3, and requires only slight excitation to break away. Consequently, the presence of such excess electrons makes the material a better conductor, i.e., its resistance to current flow is reduced.

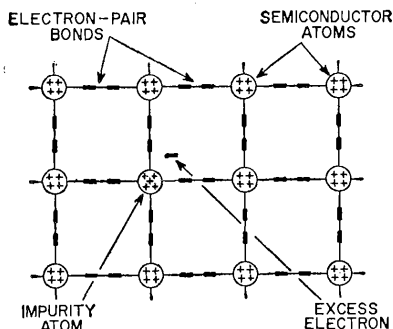

Figure 3. Lattice structure of n-type material.

Impurity elements which are added to germanium and silicon crystals to provide excess electrons include arsenic and antimony. When these elements are introduced, the resulting material is called **n-type** because the excess free electrons have a negative charge. (It should be noted, however, that the negative charge of the electrons is balanced by an equivalent positive charge in the center of the impurity atoms. Therefore, the net electrical charge of the semiconductor material is not changed.)

A different effect is produced when an impurity atom having one less valence electron than the semiconductor atom is substituted in the lattice structure. Although all the valence electrons of the impurity atom form electron-pair bonds with electrons of neighboring semiconductor atoms, one of the bonds in the lattice structure cannot be completed because the impurity atom lacks the final valence electron. As a result, a vacancy or "hole" exists in the lattice, as shown in Fig. 4. An electron from an adjacent electron-pair bond may then absorb enough energy to break its bond and move through the lattice to fill the hole. As in the case of excess electrons, the presence of "holes" encourages the flow of electrons in the semiconductor material; consequently, the conductivity is increased and the resistivity is reduced.

The vacancy or hole in the crystal structure is considered to have a

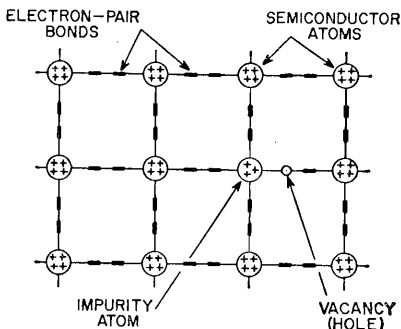

Figure 4. Lattice structure of p-type material.

positive electrical charge because it represents the absence of an electron. (Again, however, the net charge of the crystal is unchanged.) Semiconductor material which contains these "holes" or positive charges is called **p-type** material. P-type materials are formed by the addition of aluminum, gallium, or indium.

Although the difference in the chemical composition of n-type and p-type materials is slight, the differences in the electrical characteristics of the two types are substantial, and are very important in the operation of semiconductor devices.

## P-N JUNCTIONS

When n-type and p-type materials are joined together, as shown in Fig. 5, an unusual but very important phenomenon occurs at the surface

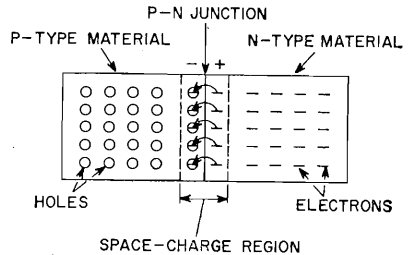

Figure 5. Interaction of holes and electrons at p-n junction.

where the two materials meet (called the **p-n junction**). An interaction takes place between the two types of material at the junction as a result of the holes in one material and the excess electrons in the other.

When a p-n junction is formed, some of the free electrons from the n-type material diffuse across the junction and fill holes in the lattice structure of the p-type material. This interaction or diffusion occurs for a short time in the immediate vicinity of the junction, and produces a small space-charge region (sometimes called the **transition region** or **depletion layer**). The p-type material in this region acquires a slight negative charge as a result of the addi-

tion of electrons from the n-type material. Conversely, the n-type material in the junction region acquires a slight positive charge as a result of the loss of excess electrons.

The potential gradient established across the space-charge region by the diffusion process is represented in Fig. 6 by an imaginary battery connected across the junction. (The

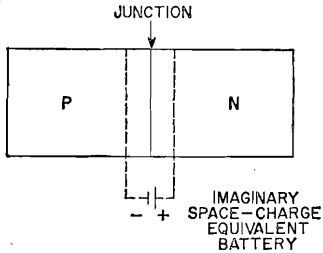

Figure 6. Potential gradient across space-charge region.

battery symbol is shown only to represent the internal effects; the potential is not measurable.) In the absence of external circuits or voltages, this potential gradient discourages further diffusion across the p-n junction because electrons from the n-type material are repelled by the slight negative charge induced in the p-type material. In effect, therefore, the potential gradient (or energy barrier, as it is sometimes called) prevents total interaction between the two types of material, and thus preserves the differences in their characteristics.

## CURRENT FLOW

When an external battery is connected across a p-n junction, the

amount of current flow is determined by the polarity of the applied voltage and its effect on the space-charge region. In Fig. 7a, the positive terminal of the battery is connected to the n-type material and the negative terminal to the p-type material. In this arrangement, the free electrons in the n-type material are attracted toward the positive terminal of the battery and away from the junction. At the same time, electrons from the negative terminal of the battery enter the p-type material and diffuse toward the junction, filling holes in the lattice structure as they approach the junction. As a result, the space-charge region at the junction becomes effectively wider, and the potential gradient increases until it approaches the potential of the external battery. Current flow is then extremely small because no voltage difference (electric field) exists across either the p-type or the n-type region. Under these conditions, the p-n junction is said to be reverse-biased.

In Fig. 7b, the positive terminal of the external battery is connected to the p-type material and the negative terminal to the n-type material. In this arrangement, electrons in the p-type material near the positive terminal of the battery break their electron-pair bonds and enter the battery, creating new holes. At the same time, electrons from the negative terminal of the battery enter the n-type material and diffuse toward the junction. As a result, the space-charge region becomes effectively narrower, and the energy barrier decreases to an insignificant value. Excess electrons from the n-type mate-

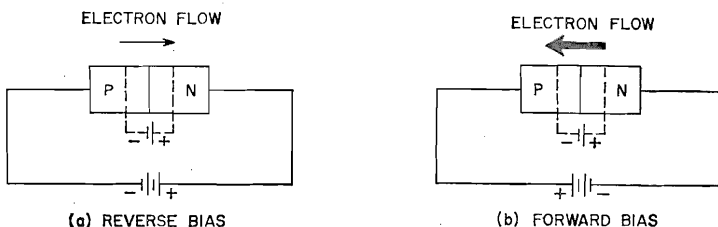

Figure 7. Electron current flow in biased p-n junctions.

rial can then penetrate the space-charge region, flow across the junction, and move by way of the holes in the p-type material toward the positive terminal of the battery. This electron flow continues as long as the external voltage is applied. Under these conditions, the junction is said to be **forward-biased**.

The generalized voltage-current characteristic for a p-n junction in Fig. 8 shows both the reverse-bias and forward-bias regions. In the forward-bias region, current rises

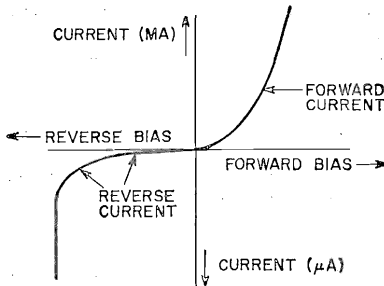

Figure 8. Voltage-current characteristic for a p-n junction.

rapidly as the voltage is increased and is quite high. Current in the reverse-bias region is usually much lower. Excessive voltage (bias) in either direction should be avoided in normal applications because excessive currents and the resulting high temperatures may permanently damage the semiconductor device.

### N-P-N AND P-N-P STRUCTURES

Fig. 7 shows that a p-n junction biased in the reverse direction is equivalent to a high-resistance element (low current for a given applied voltage), while a junction biased in the forward direction is equivalent to a low-resistance element (high current for a given applied voltage). Because the power developed by a given current is greater in a high-resistance element than in a low-resistance element ( $P=I^2R$ ), power gain can be obtained in a structure containing two such resistance elements if the cur-

rent flow is not materially reduced. A device containing two p-n junctions biased in opposite directions can operate in this fashion.

Such a two-junction device is shown in Fig. 9. The thick end layers

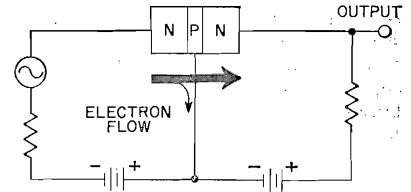

Figure 9. N-P-N structure biased for power gain.

are made of the same type of material (n-type in this case), and are separated by a very thin layer of the opposite type of material (p-type in the device shown). By means of the external batteries, the left-hand (n-p) junction is biased in the forward direction to provide a low-resistance input circuit, and the right-hand (p-n) junction is biased in the reverse direction to provide a high-resistance output circuit.

Electrons flow easily from the left-hand n-type region to the center p-type region as a result of the forward biasing. Most of these electrons diffuse through the thin p-type region, however, and are attracted by the positive potential of the external battery across the right-hand junction. In practical devices, approximately 95 to 99.5 per cent of the electron current reaches the right-hand n-type region. This high percentage of current penetration provides power gain in the high-resistance output circuit and is the basis for transistor amplification capability.

The operation of p-n-p devices is similar to that shown for the n-p-n device, except that the bias-voltage polarities are reversed, and electron-current flow is in the opposite direction. (Many discussions of semiconductor theory assume that the "holes" in semiconductor material constitute the charge carriers in p-n-p devices, and discuss "hole currents" for these

devices and "electron currents" for n-p-n devices. Other texts discuss neither hole current nor electron current, but rather "conventional current flow", which is assumed to travel through a circuit in a direction from the positive terminal of the external battery back to its negative terminal. For the sake of simplicity, this discussion will be restricted to the concept of electron current flow, which travels from a negative to a positive terminal.)

### TYPES OF DEVICES

The simplest type of semiconductor device is the diode, which is represented by the symbol shown in Fig. 10. Structurally, the diode is basically a p-n junction similar to those shown in Fig. 7. The n-type material which

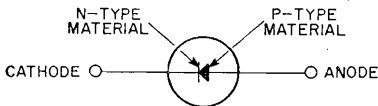

Figure 10. Schematic symbol for a semiconductor diode.

serves as the negative electrode is referred to as the **cathode**, and the p-type material which serves as the positive electrode is referred to as the **anode**. The arrow symbol used for the anode represents the direction of "conventional current flow" mentioned above; electron current flows in a direction opposite to the arrow.

Because the junction diode conducts current more easily in one direction than in the other, it is an effective rectifying device. If an ac signal is applied, as shown in Fig. 11, electron current flows freely during the positive half cycle, but little or no current flows during the negative half cycle.

One of the most widely used types of semiconductor diode is the **silicon rectifier**. These devices are available in a wide range of current capabilities, ranging from tenths of an ampere to 40 amperes or more, and are capable of operation at voltages as high as 800 volts or more.

Parallel and series arrangements of silicon rectifiers permit even further extension of current and voltage

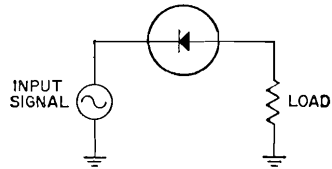

Figure 11. Simple diode rectifying circuit.

limits. Characteristics and applications of these devices are discussed in detail in the Silicon Rectifiers Section.

Several variations of the basic junction diode structure have been developed for use in special applications. The most important of these developments are the **tunnel diode**, which is used for amplification, oscillation, switching, and pulse generation, and the **varactor** or **parametric diode**, which amplifies at very high frequencies. These special diodes are described in the Tunnel, Varactor, and Other Diodes Section.

When a second junction is added to a semiconductor diode to provide power or voltage amplification (as shown in Fig. 9), the resulting device is called a **transistor**. The three regions of the device are called the **emitter**, the **base**, and the **collector**, as shown in Fig. 12. In normal operation, the emitter-to-base junction is

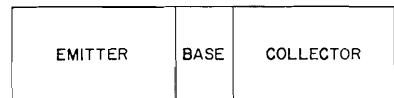

Figure 12. Functional diagram of transistor structure.

biased in the forward direction, and the collector-to-base junction in the reverse direction.

Different symbols are used for n-p-n and p-n-p transistors to show the difference in the direction of current flow in the two types of devices. In the n-p-n transistor shown in Fig.



13a, electrons flow from the emitter to the collector. In the p-n-p transistor shown in Fig. 13b, electrons

conductor diodes, the arrow indicates the direction of "conventional current flow" in the circuit.)

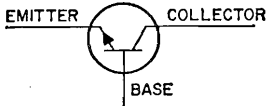

(a) N-P-N TRANSISTOR

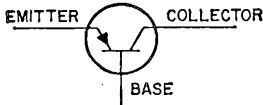

(b) P-N-P TRANSISTOR

Figure 13. Schematic symbols for transistors.

flow from the collector to the emitter. In other words, the direction of dc electron current is always opposite to that of the arrow on the emitter lead. (As in the case of semi-

The first two letters of the n-p-n and p-n-p designations indicate the respective polarities of the voltages applied to the emitter and the collector in normal operation. In an n-p-n transistor, the emitter is made negative with respect to both the collector and the base, and the collector is made positive with respect to both the emitter and the base. In a p-n-p transistor, the emitter is made positive with respect to both the collector and the base, and the collector is made negative with respect to both the emitter and the base.

The transistor, which is a three-element device, can be used for a wide variety of control functions, including amplification, oscillation, and frequency conversion. Transistor characteristics and applications are discussed in detail in the following sections.

# Transistor Designs and Circuit Configurations

THE performance of transistors in electronic equipment depends on many factors besides the basic characteristics of the semiconductor material. The two most important factors are the design and fabrication of the transistor structure and the general circuit configuration used.

## DESIGN AND FABRICATION

The ultimate aim of all transistor fabrication techniques is the construction of two parallel p-n junctions with controlled spacing between the junctions and controlled impurity levels on both sides of each junction. A variety of structures has been developed in the course of transistor evolution.

The earliest transistors made were of the point-contact type shown in Fig. 14. In this type of structure, two pointed wires were placed next

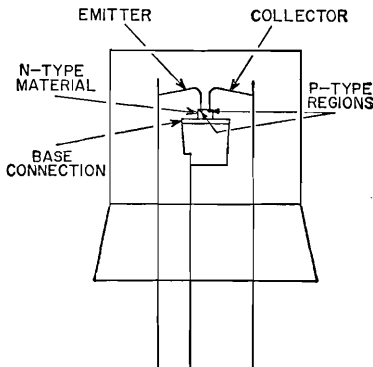

Figure 14. Structure of point-contact transistor.

to each other on an n-type block of semiconductor material. The p-n junctions were formed by electrical pulsing of the wires. This type has been superseded by junction transistors, which are fabricated by the various alloy, diffusion, and crystal-growth techniques described below.

In grown-junction transistors, the impurity content of the semiconductor material is changed during the growth of the original crystal ingot to provide the p-n-p or n-p-n regions. The grown crystal is then sliced into a large number of small-area devices, and contacts are made to each region of the devices, as shown in Fig. 15. The finished transistor is encased in plastic or a hermetically sealed enclosure.

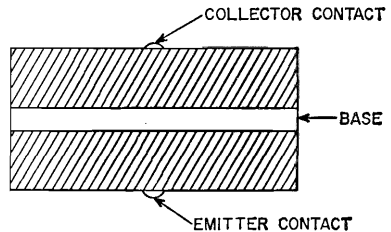

Figure 15. Structure of grown-junction transistor.

In alloy-junction transistors, two small "dots" of a p-type or n-type impurity element are placed on opposite sides of a thin wafer of n-type or p-type semiconductor material, respectively, as shown in Fig. 16. After proper heating, the impurity "dots" alloy with the semiconductor material to form the regions for the

emitter and collector junctions. The base connection in this structure is made to the original semiconductor wafer.

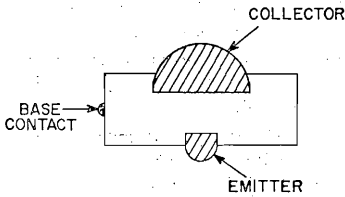

Figure 16. Structure of alloy-junction transistor.

The drift-field transistor is a modified alloy-junction device in which the impurity concentration in the base wafer is diffused or graded, as shown in Fig. 17. Two advantages are derived from this structure: (a) the resultant built-in voltage or "drift field" speeds current flow, and (b) the ability to use a heavy impurity concentration in the vicinity of the emitter and a light concentration in the vicinity of the collector makes it possible to minimize capacitive charging times. Both these advantages lead to a substantial extension of the frequency performance over the alloy-junction device.

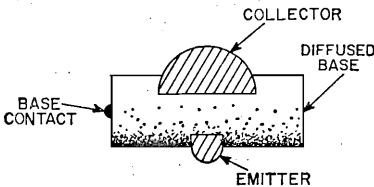

Figure 17. Structure of drift-field transistor.

Mesa and planar transistors use newer construction techniques which are better suited to many applications than the grown-junction or alloy methods. These transistors involve two basic processes: (1) the use of diffusion masking materials and photolithographic techniques to obtain a planar structure in which all the p-n junctions are buried under a protective passivating layer, and (2) the use of a separate collector-contact diffusion or an epitaxial growth to reduce the electrical series resistance in the collector. In these

types, the original semiconductor wafer serves as the collector. The base region is diffused into the wafer, and the emitter "dot" or region is then alloyed or diffused into the base region. A "mesa" or flat-topped peak may then be etched to reduce the collector area at the base-collector junction. The mesa structure is inherently rugged, has large power-dissipation capability, and can operate at very high frequencies.

Figs. 18, 19, and 20 show some of the mesa and planar structures in production today. The grading of the impurity concentration in the base region results in a drift field and in reduced base-lead resistance. The use of a diffused emitter region permits tight geometry control. The use of a relatively light impurity concentration in the collector region results in high collector-breakdown voltages and low collector-junction capacitance.

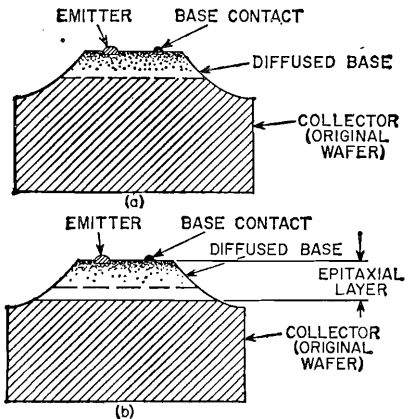
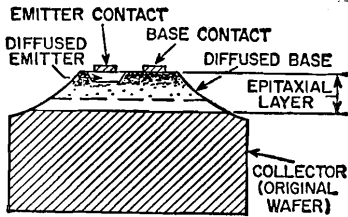

Figure 18. Structure of (a) mesa transistor and (b) epitaxial transistor.

### BASIC CIRCUITS

There are three basic ways of connecting transistors in a circuit: common-base, common-emitter, and common-collector. In the common-base (or grounded-base) connection shown in Fig. 21, the signal is introduced into the emitter-base circuit and extracted from the collector-base circuit. (Thus the base element of the transistor is common to both the input and output circuits.) Because the



(a)

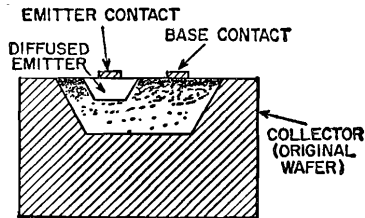

(b)

Figure 19. Structure of (a) double-diffused epitaxial mesa transistor and (b) double-diffused planar transistor.

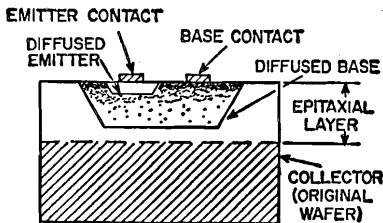

(a)

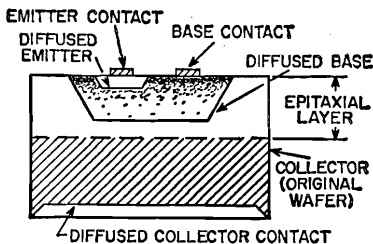

(b)

Figure 20. Structure of (a) double-diffused epitaxial planar transistor and (b) triple-diffused epitaxial planar transistor.

input or emitter-base circuit has a low impedance (resistance plus reactance) in the order of 0.5 to 50 ohms, and the output or collector-base circuit has a high impedance in the order of 1000 ohms to one megohm, the voltage or power gain in this type of configuration may be in the order of 1500.

The direction of the arrows in Fig. 21 indicates electron current flow. As stated previously, most of the current from the emitter flows to the collector; the remainder flows through the base. In practical transistors, from 95 to 99.5 per cent of the emitter current reaches the collector. The current gain of this configuration, therefore, is always less than unity, usually in the order of 0.95 to 0.995.

The waveforms in Fig. 21 represent the input voltage produced by the signal generator  $e_s$  and the output voltage developed across the load resistor  $R_L$ . When the input voltage is positive, as shown at AB, it opposes the forward bias produced by the base-emitter battery, and thus reduces current flow through the n-p-n transistor. The reduced electron current flow through  $R_L$  then causes the top point of the resistor to become less negative (or more positive) with respect to the lower point, as shown at A'B' on the output waveform. Conversely, when the input signal is negative, as at CD, the output signal is also negative, as at C'D'. Thus, the phase of the signal remains unchanged in this circuit, i.e., there is no voltage phase reversal between the input and the output of a common-base amplifier.

In the common-emitter (or grounded-emitter) connection shown in Fig. 22, the signal is introduced into the base-emitter circuit and extracted from the collector-emitter circuit. This configuration has more moderate input and output impedances than the common-base circuit. The input (base-emitter) impedance is in the range of 20 to 5000 ohms, and the output (collector-emitter) impedance is about 50 to 50,000

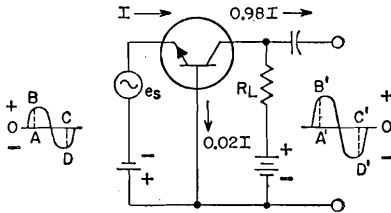

Figure 21. Common-base circuit configuration.

ohms. Power gains in the order of 10,000 (or approximately 40 db) can be realized with this circuit because it provides both current gain and voltage gain.

Current gain in the common-emitter configuration is measured between the base and the collector, rather than between the emitter and the collector as in the common-base circuit. Because a very small change in base current produces a relatively large change in collector current, the current gain is always greater than unity in a common-emitter circuit; a typical value is about 50.

The input signal voltage undergoes a phase reversal of 180 degrees in a common-emitter amplifier, as shown by the waveforms in Fig. 22.

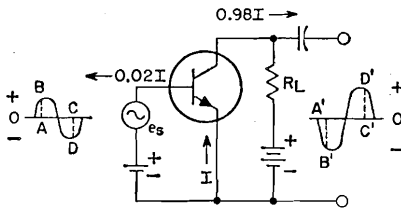

Figure 22. Common-emitter circuit configuration.

When the input voltage is positive, as shown at AB, it increases the forward bias across the base-emitter junction, and thus increases the total

current flow through the transistor. The increased electron flow through  $R_L$  then causes the output voltage to become negative, as shown at A'B'. During the second half-cycle of the waveform, the process is reversed, i.e., when the input signal is negative, the output signal is positive (as shown at CD and C'D').

The third type of connection, shown in Fig. 23, is the common-collector (or grounded-collector) circuit. In

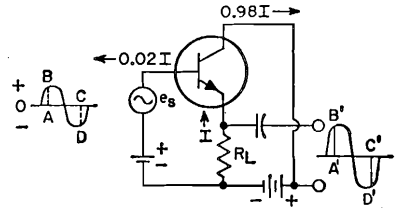

Figure 23. Common-collector circuit configuration.

this configuration, the signal is introduced into the base-collector circuit and extracted from the emitter-collector circuit. Because the input impedance of the transistor is high and the output impedance low in this connection, the voltage gain is less than unity and the power gain is usually lower than that obtained in either a common-base or a common-emitter circuit. The common-collector circuit is used primarily as an impedance-matching device. As in the case of the common-base circuit, there is no phase reversal of the signal between the input and the output.

The circuits shown in Figs. 21 through 23 are biased for n-p-n transistors. When p-n-p transistors are used, the polarities of the batteries must be reversed. The voltage phase relationships, however, remain the same.

# Transistor Characteristics

THE term "characteristic" is used to identify the distinguishing electrical features and values of a transistor. These values may be shown in curve form or they may be tabulated. When the characteristic values are given in curve form, the curves may be used for the determination of transistor performance and the calculation of additional transistor parameters.

Characteristic values are obtained from electrical measurements of transistors in various circuits under certain definite conditions of current and voltage. Static characteristics are obtained with dc potentials applied to the transistor electrodes. Dynamic characteristics are obtained with an ac voltage on one electrode under various conditions of dc potentials on all the electrodes. The dynamic characteristics, therefore, are indicative of the performance capabilities of the transistor under actual working conditions.

Published data for transistors include both electrode characteristic curves and transfer characteristic curves. These curves present the same information, but in two different forms to provide more useful data. Because transistors are used most often in the common-emitter configuration, characteristic curves are usually shown for the collector or output electrode. The collector-characteristic curve is obtained by varying collector-to-emitter voltage and measuring collector current for different values of base current. The transfer-characteristic curve is ob-

tained by varying the base-to-emitter (bias) voltage at a specified or constant collector voltage, and measuring collector current for different base currents. A collector-characteristic family of curves is shown in Fig. 24. Fig. 25 shows the transfer-characteristic family of curves for the same transistor.

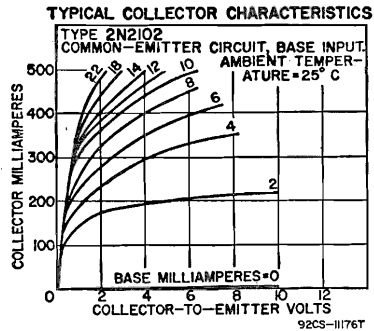

Figure 24. Collector-characteristic curves.

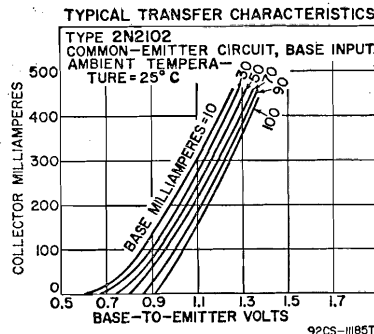

Figure 25. Transfer-characteristic curves.



One of the most important characteristics of a transistor is its forward current-transfer ratio, i.e., the ratio of the current in the output electrode to the current in the input electrode. Because of the different ways in which transistors may be connected in circuits, the forward current-transfer ratio is specified for a particular circuit configuration. The common-base forward current-transfer ratio is often called alpha (or  $\alpha$ ), and the common-emitter forward current-transfer ratio is often called beta (or  $\beta$ ).

In the common-base circuit shown in Fig. 21, the emitter is the input electrode and the collector is the output electrode. The dc alpha, therefore, is the ratio of the dc collector current  $I_C$  to the dc emitter current  $I_E$ :

$$\alpha = \frac{I_C}{I_E} = \frac{0.98 I}{I} = 0.98$$

In the common-emitter circuit shown in Fig. 22, the base is the input electrode and the collector is the output electrode. The dc beta, therefore, is the ratio of the dc collector current  $I_C$  to the dc base current  $I_B$ :

$$\beta = \frac{I_C}{I_B} = \frac{0.98 I}{0.02 I} = 49$$

Because the ratios given above are based on dc currents, they are properly called dc alpha and dc beta. It is more common, however, for the current-transfer ratio to be given in terms of the ratio of the signal currents in the input and output electrodes, or the ratio of a change in the output current to the input signal current which causes the change. Fig. 26 shows typical electrode currents in a common-emitter circuit under no-signal conditions and with a one-microampere signal applied to the base. The signal current of one microampere in the base causes a change of 49 microamperes (147-98) in the collector current. Thus the ac beta for the transistor is 49.

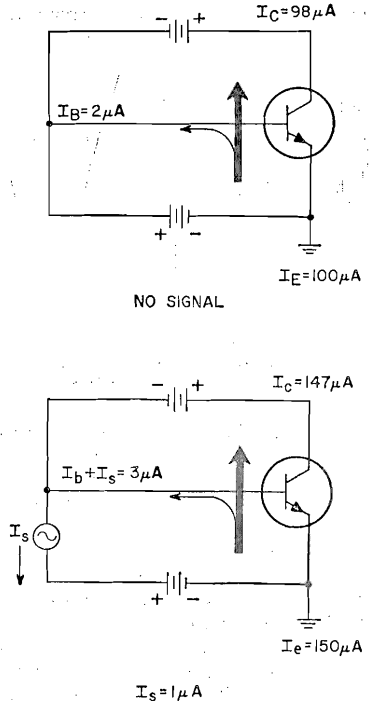

Figure 26. Electrode currents under no-signal and signal conditions.

The frequency cutoff of a transistor is defined as the frequency at which the value of alpha (for a common-base circuit) or beta (for a common-emitter circuit) drops to 0.707 times its one-kilocycle value. The gain-bandwidth product is the frequency at which the common-emitter forward current-transfer ratio (beta) is equal to unity. These characteristics provide an approximate indication of the useful frequency range of the device, and help to determine the most suitable circuit configuration for a particular application. Fig. 27 shows typical curves of alpha and beta as functions of frequency.

Extrinsic transconductance may be defined as the quotient of a small change in collector current divided by the small change in emitter-to-base voltage producing it, under the condition that other voltages remain

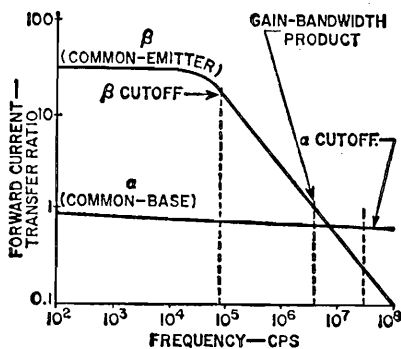

Figure 27. Forward current-transfer ratio as a function of frequency.

unchanged. Thus, if an emitter-to-base voltage change of 0.1 volt causes a collector-current change of 3 milliamperes (0.003 ampere) with other voltages constant, the transconductance is 0.003 divided by 0.1, or 0.03 mho. (A "mho" is the unit of conductance, and was named by spelling "ohm" backward.) For convenience, a millionth of a mho, or a micro-mho ( $\mu\text{mho}$ ), is used to express transconductance. Thus, in the example, 0.03 mho is 30,000 micromhos.

**Cutoff currents** are small dc reverse currents which flow when a transistor is biased into non-conduction. They consist of **leakage currents**, which are related to the surface characteristics of the semiconductor material, and **saturation currents**, which are related to the impurity concentration in the material and which increase with increasing temperatures. Collector-cutoff current is the dc current which flows in the reverse-biased collector-to-base circuit when the emitter-to-base circuit is open. Emitter-cutoff current is the current which flows in the reverse-biased emitter-to-base circuit when the collector-to-base circuit is open.

**Transistor breakdown voltages** define the voltage values between two specified electrodes at which the crystal structure changes and current begins to rise rapidly. The voltage then remains relatively constant over a wide range of electrode currents.

Breakdown voltages may be measured with the third electrode open, shorted, or biased in either the forward or the reverse direction. For example, Fig. 28 shows a series of collector-characteristic curves for different base-bias conditions. It can be seen that the collector-to-emitter breakdown voltage increases as the base-to-emitter bias decreases from the normal forward values through zero to reverse values. The symbols shown on the abscissa are sometimes used to designate collector-to-emitter breakdown voltages with the base open ( $BV_{CBO}$ ), with external base-to-emitter resistance ( $BV_{CBE}$ ), with the base shorted to the emitter ( $BV_{CES}$ ), and with a reverse base-to-emitter voltage ( $BV_{CEX}$ ).

As the resistance in the base-to-emitter circuit decreases, the collector characteristic develops two breakdown points, as shown in Fig. 28. After the initial breakdown, the collector-to-emitter voltage decreases with increasing collector current until another breakdown occurs at a lower voltage. This minimum collector-to-emitter breakdown voltage is called the **sustaining voltage**.

(In large-area power transistors, there is a destructive mechanism referred to as "second breakdown". This condition is not a voltage breakdown, but rather an electrically and thermally regenerative process in which current is focused in a very small area of the order of the diameter of a human hair. The very high current, together with the voltage across the transistor, causes a localized heating that may melt a minute hole from the collector to the emitter of the transistor and thus cause a short circuit. This regenerative process is not initiated unless certain high voltages and currents are coincident for certain finite lengths of time.)

The curves at the left of Fig. 28 show typical collector characteristics under normal forward-bias conditions. For a given base input current,

the collector-to-emitter saturation voltage is the minimum voltage required to maintain the transistor in full conduction (i.e., in the saturation region). Under saturation conditions, a further increase in forward bias produces no corresponding in-

a sharp increase in current. Punch-through voltage does not result in permanent damage to a transistor, provided there is sufficient impedance in the power-supply source to limit the transistor dissipation to safe values.

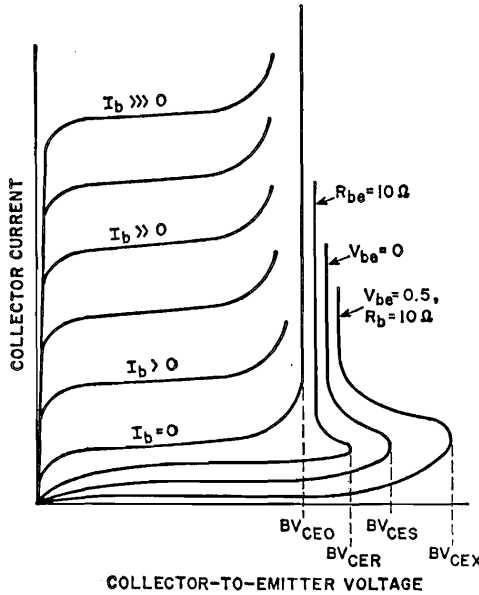

Figure 28. Typical collector-characteristic curves showing locations of various breakdown voltages.

crease in collector current. Saturation voltages are very important in switching applications, and are usually specified for several conditions of electrode currents and ambient temperatures.

**Reach-through (or punch-through) voltage** defines the voltage value at which the depletion region in the collector region passes completely through the base region and makes contact at some point with the emitter region. This "reach-through" phenomenon results in a relatively low-resistance path between the emitter and the collector, and causes

Stored base charge is a measure of the amount of charge which exists in the base region of the transistor at the time that forward bias is removed. This stored charge supports an undiminished collector current in the saturation region for some finite time before complete switching is effected. This delay interval, called the "storage time", depends on the degree of saturation into which the transistor is driven. (This effect is discussed in more detail under "Switching" in the Transistor Applications Section.)

# Transistor Applications

THE diversified applications of transistors are treated in this section under the three major classifications of Amplification, Oscillation, and Switching. Because various biasing and coupling methods are used in transistor circuits, bias and coupling arrangements are discussed separately before specific applications are considered. Also discussed are stability requirements for transistor circuits.

## BIASING

The operating point for a particular transistor is established by the quiescent (dc, no-signal) values of collector voltage and emitter current. In general, a transistor may be considered as a current-operated device, i.e., the current flowing in the emitter-base circuit controls the current flowing in the collector circuit. The voltage and current values selected, as well as the particular biasing arrangement used, depend upon both the transistor characteristics and the specific requirements of the application.

As mentioned previously, biasing of a transistor for most applications consists of forward bias across the emitter-base junction and reverse bias across the collector-base junction. In Figs. 21, 22, and 23, two batteries were used to establish bias of the correct polarity for an n-p-n transistor in the common-base, common-emitter, and common-collector circuits, respectively. Many variations of these basic circuits can also be used. (In these simplified circuits, inductors and transformers are represented only by their series resistances.)

A simplified biasing arrangement for the common-base circuit is shown in Fig. 29. Bias for both the collector-base junction and the emitter-base junction is obtained from the single battery through the voltage-divider network consisting of resistors  $R_2$  and  $R_3$ . (For the n-p-n transistor shown in Fig. 29a, the emitter-base junction is forward-biased because the emitter is negative with respect to the base, and the collector-base

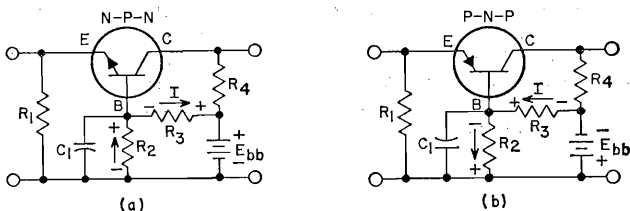

Figure 29. Biasing network for common-base circuit for (a) n-p-n and (b) p-n-p transistors.

junction is reverse-biased because the collector is positive with respect to the base, as shown. For the p-n-p transistor shown in Fig. 29b, the polarity of the battery and of the electrolytic bypass capacitor  $C_1$  is reversed.) The electron current  $I$  from the battery and through the voltage divider causes a voltage drop across resistor  $R_2$  which biases the emitter with respect to the base. This resistor is bypassed with capacitor  $C_1$  so that the base is effectively grounded for ac signals.

The common-emitter circuit also can be biased by means of a single battery. The simplified arrangement shown in Fig. 30 is commonly called "fixed bias". In this case, both the base and the collector are made positive with respect to the emitter by means of the battery. The base resistance  $R_B$  is then selected to provide the desired base current for the transistor (which, in turn, establishes the desired emitter current), by means of the following expression:

$$R_B = \frac{\text{Battery volts } E_{bb}}{\text{Desired base amperes } I_B}$$

In the circuit shown, for example, the battery voltage is six volts. The

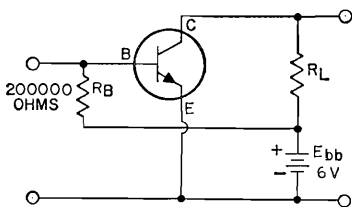

Figure 30. "Fixed-bias" arrangement for common-emitter circuit.

value of  $R_B$  was selected to provide a base current of 30 microamperes, as follows:

$$R_B = \frac{E_{bb}}{I_B} = \frac{6}{30 \times 10^{-6}} = 200,000 \text{ ohms}$$

The fixed-bias arrangement shown in Fig. 30, however, is not a satisfactory method of biasing the base in a common-emitter circuit. The critical base current in this type of circuit is very difficult to maintain under fixed-bias conditions because

of variations between transistors and the sensitivity of these devices to temperature changes. This problem is partially overcome in the "self-bias" arrangement shown in Fig. 31.

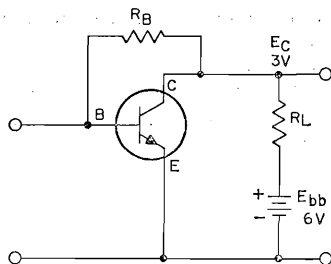

Figure 31. "Self-bias" arrangement for common-emitter circuit.

In this circuit, the base resistor is tied directly to the collector. This connection helps to stabilize the operating point because an increase or decrease in collector current produces a corresponding increase or decrease in base bias. The value of  $R_B$  is then determined as described above, except that the collector voltage  $E_C$  is used in place of the supply voltage  $E_{bb}$ :

$$R_B = \frac{E_C}{I_B} = \frac{3}{30 \times 10^{-6}} = 100,000 \text{ ohms}$$

The arrangement shown in Fig. 31 overcomes many of the disadvantages of fixed bias, although it reduces the effective gain of the circuit.

In the bias method shown in Fig. 32, the voltage-divider network composed of  $R_1$  and  $R_2$  provides the required forward bias across the base-emitter junction. The value of the base bias is determined by the current through the voltage divider. Any change in collector current

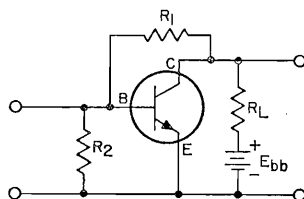

Figure 32. Bias network using voltage-divider arrangement for increased stability.

caused by a change in emitter current, therefore, automatically changes the base bias. This type of circuit provides less gain than the circuit of Fig. 31, but is commonly used because of its inherent stability.

The common-emitter circuits shown in Figs. 33 and 34 may be used to provide stability and yet minimize loss of gain. In Fig. 33, a resistor  $R_B$  is added to the emitter circuit, and the base resistor  $R_2$  is returned

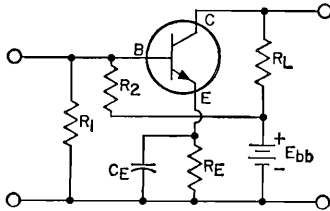

Figure 33. Bias network using emitter stabilizing resistor.

to the positive terminal of the battery instead of to the collector. The emitter resistor  $R_E$  provides additional stability; it is bypassed with capacitor  $C_E$ . The value of  $C_E$  is usually about 50 microfarads, but may be much higher depending, among other things, on the lowest frequency to be amplified.

In Fig. 34, the  $R_2R_3$  voltage-divider network is split, and all ac feedback currents through  $R_3$  are shunted to ground (bypassed) by capacitor  $C_1$ . The value of  $R_3$  is usually larger than the value of  $R_2$ . The total resistance of  $R_2$  and  $R_3$  should equal the resistance of  $R_2$  in Fig. 32.

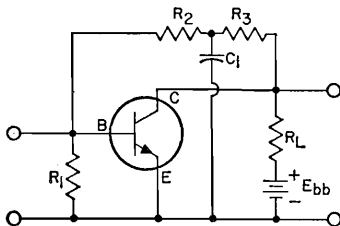

Figure 34. Bias network using split voltage-divider network.

In practical circuit applications, any combination of the arrange-

ments shown in Figs. 31, 32, 33, and 34 may be used. However, the stability of Figs. 31, 32, and 34 may be poor unless the voltage drop across the load resistor  $R_L$  is at least one-third the value of the supply voltage. The determining factors in the selection of the biasing circuit are usually gain and circuit stability.

In many cases, the bias network may include special elements to compensate for the effects of variations in ambient temperature or in supply voltage. For example, the thermistor (temperature-sensitive resistor) shown in Fig. 35a is used to compensate for the rapid increase of collector current with increasing temperature. Because the thermistor resistance decreases as the temperature increases, the bias voltage is reduced and the collector current tends to remain constant. The addition of the shunt and series resistances provides most effective com-

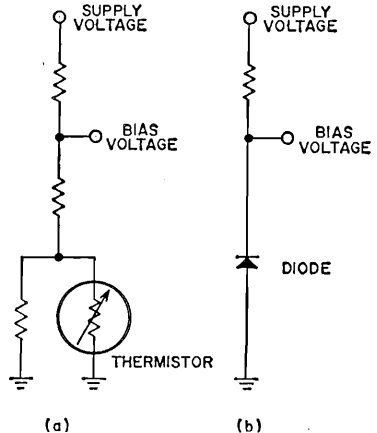

Figure 35. Bias networks including (a) a thermistor and (b) a temperature- and voltage-compensating diode.

pensation over a desired temperature range.

The diode biasing network shown in Fig. 35b stabilizes collector current for variations in both temperature and supply voltage. The diode current determines a bias voltage which establishes the transistor idling current (collector current under no-signal conditions). As the tem-



perature increases, this bias voltage decreases. Because the transistor characteristic also shifts in the same direction and magnitude, however, the idling current remains essentially independent of temperature. Temperature stabilization with a diode network is substantially better than that provided by most thermistor bias networks.

In addition, the diode bias current varies in direct proportion with changes in supply voltage. The resultant change in bias voltage is small, however, so that the idling current also changes in direct proportion to the supply voltage. Supply-voltage stabilization with a diode biasing network reduces current variation to about one-fifth that obtained when resistor or thermistor bias is used.

### COUPLING

Three basic methods are used to couple transistor stages: transformer, resistance-capacitance, and direct coupling.

The major advantage of **transformer coupling** is that it permits the input and output impedance of the transistor to be matched for maximum power gain. The transformer-coupled common-emitter n-p-n stage shown in Fig. 36 employs both fixed and self bias, and includes an emitter resistor  $R_E$  for

herent in this transformer is not significant in transistor circuits because, as mentioned previously, the transistor is a current-operated device. Although the voltage is stepped down, the available current is stepped up. The change in base current resulting from the presence of the signal causes an ac collector current to flow in the primary winding of transformer  $T_2$ , and a power gain can be measured between  $T_1$  and  $T_2$ .

This use of a voltage step-down transformer is similar to that in the output stage of an audio amplifier, where a step-down transformer is normally used to drive the loudspeaker, which is also a current-operated device. The purpose of the transformer in both cases is to transfer power from one impedance level to another.

The voltage-divider network consisting of resistors  $R_1$  and  $R_2$  in Fig. 36 provides bias for the transistor. The voltage divider is bypassed by capacitor  $C_1$  to avoid signal attenuation. The stabilizing emitter resistor  $R_E$  permits normal variations of the transistor and circuit elements to be compensated for automatically without adverse effects. This resistor  $R_E$  is bypassed by capacitor  $C_2$ . The voltage supply  $E_{bb}$  is also bypassed, by capacitor  $C_3$ , to prevent feedback

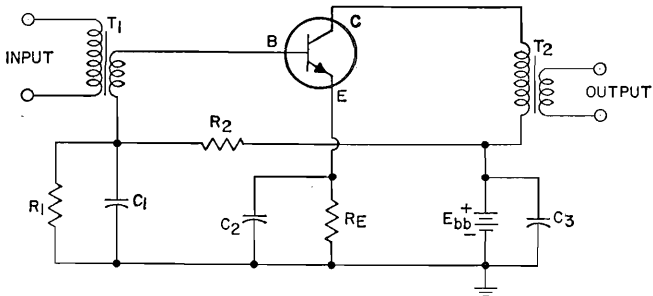

Figure 36. Transformer-coupled common-emitter stage.

stabilization. The voltage step-down transformer  $T_1$  couples the signal from the collector of the preceding stage to the base of the common-emitter stage. The voltage loss in-

in the event that ac signal voltages are developed across the power supply. Capacitor  $C_1$  and  $C_2$  may normally be replaced by a single capacitor connected between the emit-

ter and the bottom of the secondary winding of transformer  $T_1$  with little change in performance.

Because there is no resistor in the collector circuit to dissipate power, the efficiency of a transformer-coupled stage approaches the theoretical maximum of 50 per cent. In addition, the very low impedance in the base circuit may simplify the problem of temperature stabilization. When a large stabilizing resistor is used in series with the emitter, the circuit stability factor may be very high.

The use of resistance-capacitance coupling usually permits some economy of circuit costs and reduction of size, with some accompanying sacrifice of gain. This method of coupling is particularly desirable in low-level, low-noise audio amplifier stages to minimize hum pickup from stray magnetic fields. Use of resistance-capacitance (RC) coupling in battery-operated equipment is usually limited to low-power operation. The frequency response of an RC-coupled stage is normally better than

that of a transformer-coupled stage.

Fig. 37a shows a two-stage RC-coupled circuit using n-p-n transistors in the common-emitter configuration. The method of bias is similar to that used in the transformer-coupled circuit of Fig. 36. The major additional components are the collector load resistances  $R_{L1}$  and  $R_{L2}$  and the coupling capacitor  $C_c$ . The value of  $C_c$  must be made fairly large, in the order of 2 to 10 microfarads, because of the small input and load resistances involved. (It should be noted that electrolytic capacitors are normally used for coupling in transistor audio circuits. Polarity must be observed, therefore, to obtain proper circuit operation. Occasionally, excessive leakage current through an electrolytic coupling capacitor may adversely affect transistor operating currents.)

**Impedance coupling** is a modified form of resistance-capacitance coupling in which inductances are used to replace the load resistors. This type of coupling is rarely used except in special applications where supply voltages are low and cost is

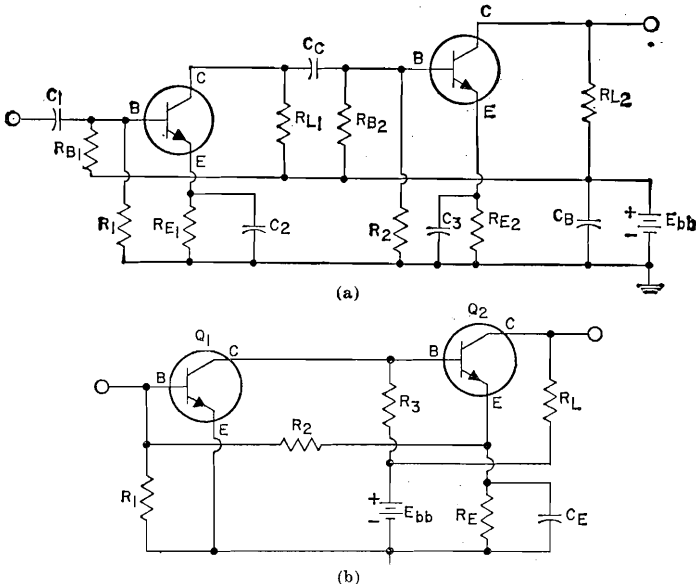

Figure 37. (a) Two-stage resistance-capacitance-coupled circuit and (b) two-stage direct-coupled circuit.

not a significant factor.

Direct coupling is used primarily when cost is an important factor. (It should be noted that direct-coupled amplifiers are not inherently dc amplifiers, i.e., that they cannot always amplify dc signals. Low-frequency response is usually limited by other factors than the coupling network.) In the direct-coupled amplifier shown in Fig. 37b, resistor  $R_3$  serves as both the collector load resistor for the first stage and the bias resistor for the second stage. Resistors  $R_1$  and  $R_2$  provide circuit stability similar to that of Fig. 32 because the emitter voltage of transistor  $Q_2$  and the collector voltage of transistor  $Q_1$  are within a few tenths of a volt of each other.

Because so few circuit parts are required in the direct-coupled amplifier, maximum economy can be achieved. However, the number of stages which can be directly coupled is limited. Temperature variation of the bias current in one stage is amplified by all the stages, and severe temperature instability may result.

**CIRCUIT STABILITY**

Because transistor currents tend to increase with temperature, it is necessary in the design of transistor

circuits to include a "stability factor" to limit dissipation to safe values under the expected high-temperature operating conditions. The circuit stability factor SF is expressed as the ratio between a change in dc collector current  $I_{C0}$  and the corresponding change in dc collector-cutoff current with the emitter open  $I_{CBO}$ .

For a given set of operating voltages, the stability factor can be calculated for a maximum permissible rise in dc collector current from the room-temperature value, as follows:

$$SF = \frac{I_{C0max} - I_{C0}}{I_{CBO2} - I_{CBO1}}$$

where  $I_{C01}$  and  $I_{CBO1}$  are measured at 25 degrees centigrade,  $I_{CBO2}$  is measured at the maximum expected ambient (or junction) temperature, and  $I_{C0max}$  is the maximum permissible collector current for the specified collector-to-emitter voltage at the maximum expected ambient (or junction) temperature (to keep transistor dissipation within ratings).

The calculated values of SF can then be used, together with the appropriate values of beta and  $r_b$  (base-connection resistance), to determine suitable resistance values for the transistor circuit. Fig. 38 shows equations for SF in terms of resist-

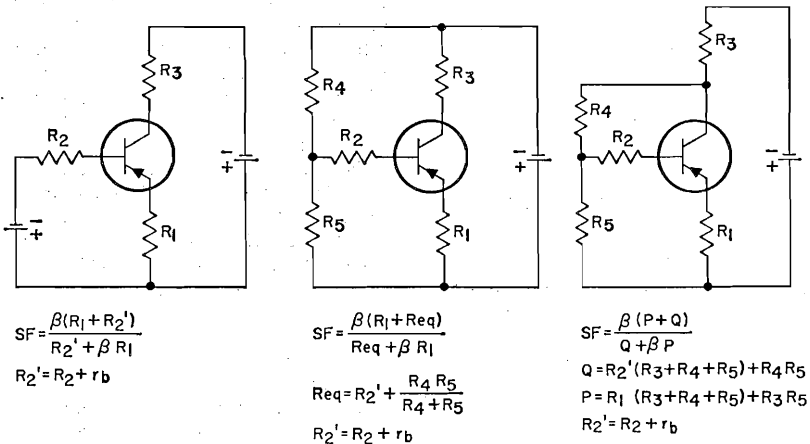

Figure 38. Circuit-stability-factor equations for three typical circuit configurations.

ance values for three typical circuit configurations. The maximum value which SF can assume is the value of beta.

## AMPLIFICATION

The amplifying action of a transistor can be used in various ways in electronic circuits, depending on the results desired. The four recognized classes of amplifier service can be defined for transistor circuits as follows:

A **class A amplifier** is an amplifier in which the base bias and alternating signal are such that collector current in a specific transistor flows continuously during the complete electrical cycle of the signal, and even when no signal is present.

A **class AB amplifier** is an amplifier in which the base bias and alternating signal are such that collector current in a specific transistor flows for appreciably more than half but less than the entire electrical cycle.

A **class B amplifier** is an amplifier in which the base is biased to approximately collector-current cutoff, so that collector current is approximately zero when no signal is applied, and so that collector current in a specific transistor flows for approximately one-half of each cycle when an alternating signal is applied.

A **class C amplifier** is an amplifier in which the base is biased to such a degree that the collector current in each transistor is zero when no signal is applied, and so that collector current in a specific transistor flows for appreciably less than one-half of each cycle when an alternating signal is applied.

For radio-frequency (rf) amplifiers which operate into selective tuned circuits, or for other amplifiers in which distortion is not a prime factor, any of the above classes of amplification may be used with either a single transistor or a push-pull stage. For audio-frequency (af) amplifiers in which distortion is an important factor, single transistors

can be used only in class A amplifiers. For class AB or class B audio-amplifier service, a balanced amplifier stage using two transistors is required. A push-pull stage can also be used in class A audio amplifiers to obtain reduced distortion and greater power output. Class C amplifiers cannot be used for audio applications.

## Audio Amplifiers

Audio amplifier circuits are used in radio and television receivers, public address systems, sound recorders and reproducers, and similar applications to amplify signals in the frequency range from 10 to 20,000 cycles per second. Each transistor in an audio amplifier can be considered as either a current amplifier or a power amplifier.

Simple class A amplifier circuits are normally used in low-level audio stages such as **preamplifiers** and **drivers**. Preamplifiers usually follow low-level output transducers such as microphones, hearing-aid and phonograph pickup devices, and recorder-reproducer heads.

One of the most important characteristics of a low-level amplifier circuit is its **signal-to-noise ratio**, or **noise figure**. The input circuit of an amplifier inherently contains some thermal noise contributed by the resistive elements in the input device. All resistors generate a predictable quantity of noise power as a result of thermal activity. This power is about 160 db below one watt for a bandwidth of 10 kilocycles.

When an input signal is amplified, therefore, the thermal noise generated in the input circuit is also amplified. If the ratio of signal power to noise power (S/N) is the same in the output circuit as in the input circuit, the amplifier is considered to be "noiseless" and is said to have a noise figure of unity, or zero db.

In practical circuits, however, the ratio of signal power to noise power is inevitably impaired during amplification as a result of the generation

of additional noise in the circuit elements. A measure of the degree of impairment is called the noise figure (NF) of the amplifier, and is expressed as the ratio of signal power to noise power at the input ( $S_i/N_i$ ) divided by the ratio of signal power to noise power at the output ( $S_o/N_o$ ), as follows:

$$NF = \frac{S_i/N_i}{S_o/N_o}$$

The noise figure in db is equal to ten times the logarithm of this power ratio. For example, an amplifier with a one-db noise figure decreases the signal-to-noise ratio by a factor of 1.26, a 3-db noise figure by a factor of 2, a 10-db noise figure by a factor of 10, and a 20-db noise figure by a factor of 100. A value of NF below 6 db is generally considered excellent.

In audio amplifiers, it is desirable that the noise figure be kept low. In general, the lowest value of NF is obtained by use of an emitter current of less than one milliamper, a collector voltage of less than two volts, and a signal-source resistance between 300 and 3000 ohms.

In the simple low-level amplifier stage shown in Fig. 39, the resistors  $R_1$  and  $R_2$  determine the base-emitter bias for the p-n-p transistor. Resistor  $R_3$  is the emitter stabilizing resistor; capacitor  $C_1$  bypasses the ac signal around  $R_3$ . The output signal is developed across the collector load resistor  $R_4$ . The collector voltage and the emitter current are kept relatively low to reduce the noise figure.

In many cases, low-level amplifier stages used as preamplifiers include some type of **frequency-compensation network** to improve either the low-frequency or the high-frequency components of the input signal. The simplest type of equalization network is shown in Fig. 40. Because

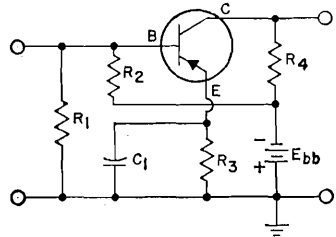

Figure 39. Simple low-level class A amplifier.

the capacitor  $C$  is effectively an open circuit at low frequencies, the low frequencies must be passed through the resistor  $R$  and are attenuated. The capacitor has a lower reactance at high frequencies, however, and bypasses high-frequency components around  $R$  so that they receive negligible attenuation. Thus the network effectively "boosts" the high frequencies.

**Feedback networks** may also be used for frequency compensation and for reduction of distortion. Basically, a feedback network returns a portion of the output signal to the input circuit of an amplifier. The feedback signal may be returned in phase with the input signal (**positive** or **regenerative feedback**) or 180 degrees out of phase with the input signal (**negative, inverse, or degenerative feedback**). In either case, the feedback can be made proportional to either the output voltage or the output current, and can be applied to either the input voltage or the input current. A negative feedback signal proportional to the output current raises the output impedance of the amplifier; negative feedback proportional to the output voltage reduces the output impedance. A negative feedback signal applied to the input current decreases the input impedance; negative feedback applied to the input voltage increases the input

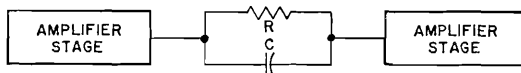

Figure 40. Simple RC frequency-compensation network.

impedance. Opposite effects are produced by positive feedback.

A simple negative or inverse feedback network which provides high-frequency boost is shown in Fig. 41.

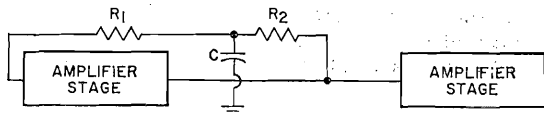

Figure 41. Negative-feedback frequency-compensation network.

This network provides equalization comparable to that obtained with Fig. 40, but is more suitable for low-level amplifier stages because it does not require high-level low frequencies. In addition, the inverse feedback improves the distortion characteristics of the amplifier.

As mentioned previously, it is undesirable to use a high-resistance signal source for an audio amplifier because of the high noise figure involved. High source resistance cannot be avoided, however, if an input device such as a crystal pickup is used. In such cases, the use of negative feedback to raise the input impedance of the amplifier circuit (to avoid mismatch loss) is no solution because feedback cannot improve the signal-to-noise ratio of the amplifier. A more practical method is to increase the input impedance somewhat by operating the transistor at

the circuit. Volume controls and their associated circuits should permit variation of gain from zero to maximum, and should attenuate all frequencies equally for all positions of the variable arm of the control. Several examples of volume controls and tone controls are shown in the Circuits Section.

Driver stages in audio amplifiers are located immediately before the power-output stage. When a single-ended class A output stage is used, the driver stage is similar to a pre-amplifier stage. When a push-pull output stage is used, however, the audio driver must provide two output signals, each 180 degrees out of phase with the other. This phase requirement can be met by use of a tapped-secondary transformer between a single-ended driver stage and the output stage, as shown in Fig. 42. The transformer  $T_1$  provides

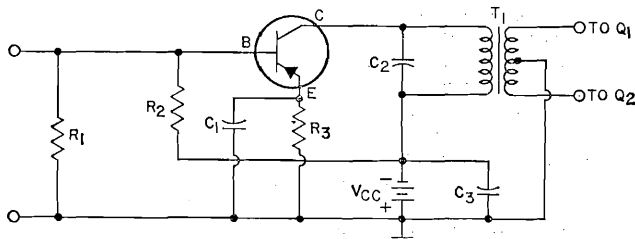

Figure 42. Driver stage for push-pull output circuit.

the lowest practical current level and by using a transistor which has a high forward current-transfer ratio.

Some preamplifier or low-level audio amplifier circuits include variable resistors or potentiometers which function as **volume** or **tone controls**.

the required out-of-phase input signals for the two transistors  $Q_1$  and  $Q_2$  in the push-pull output stage.

Transistor audio **power amplifiers** may be class A single-ended stages, or class A, class AB, or class B push-pull stages. A simple class A



single-ended power amplifier is shown in Fig. 43. Component values which will provide the desired power output can be calculated from the transistor characteristics and the supply voltage. For example, an output of four watts may be desired from a circuit operating with a supply voltage of 14.5 volts (this voltage is normally available in automobiles which have a 12-volt ignition

The current through resistor  $R_2$  is about 10 to 20 per cent of the collector current; a typical value is 15 per cent of 0.6, or 90 milliamperes.

The voltage from base to ground is equal to the base-to-emitter voltage (determined from the transistor transfer-characteristics curves for the desired collector or emitter current; normally about 0.4 volt for an emitter current of 600 milliamperes)

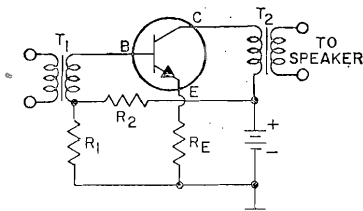

Figure 43. Class A power-amplifier circuit.

system). If losses are assumed to be negligible, the power output (PO) is equal to the peak collector voltage ( $e_c$ ) times the peak collector current ( $i_c$ ), both divided by the square root of two to obtain rms values. The peak collector current can then be determined as follows:

$$\begin{aligned}
 PO &= \frac{e_c}{\sqrt{2}} \times \frac{i_c}{\sqrt{2}} \\
 i_c &= PO(\sqrt{2}) \times \frac{\sqrt{2}}{e_c} \\
 &= 4 \sqrt{2} \times \frac{\sqrt{2}}{14.5} \\
 &= 0.55, \text{ or approximately} \\
 &\quad 0.6 \text{ ampere.}
 \end{aligned}$$

In class A service, the dc collector current and the peak collector swing are about the same. Thus, the collector voltage and current are 14.5 volts and 0.6 ampere, respectively.

The voltage drop across the resistor  $R_E$  in Fig. 43 usually ranges from 0.3 to 1 volt; a typical value of 0.6 volt can be assumed. Because the emitter current is very nearly equal to the collector current (0.6 ampere), the value of  $R_E$  must equal the 0.6-volt drop divided by the 0.6-ampere current, or one ohm.

plus the emitter-to-ground voltage (0.6 volt as described above), or one volt. The voltage across  $R_2$ , therefore, is 14.5 minus 1, or 13.5 volts. The value of  $R_2$  must equal 13.5 divided by 90, or about 150 ohms.

Because the voltage drop across the secondary winding of the driver transformer  $T_1$  is negligible, the voltage drop across  $R_1$  is one volt. The current through  $R_1$  equals the current through  $R_2$  (90 milliamperes) minus the base current. If the dc forward current-transfer ratio (beta) of the transistor selected has a typical value of 60, the base current equals the collector current of 600 milliamperes divided by 60, or 10 milliamperes. The current through  $R_1$  is then 90 minus 10, or 80 milliamperes, and the value of  $R_1$  is 1 divided by 80, or about 12 ohms.

The transformer requirements are determined from the ac voltages and currents in the circuit. The peak collector voltage swing that can be used before distortion occurs as a result of clipping of the output voltage is about 13 volts. The peak collector current swing available before current cutoff occurs is the dc current of 600 milliamperes. Therefore, the collector load impedance should

be 13 volts divided by 600 milliamperes, or about 20 ohms, and the output transformer  $T_2$  should be designed to match a 20-ohm primary impedance to the desired speaker impedance. If a 3.2-ohm speaker is used, for example, the impedance values for  $T_2$  should be 20 ohms to 3.2 ohms.

The total input power to the circuit of Fig. 43 is equal to the voltage required across the secondary winding of the driver transformer  $T_1$ , times the current. The driver signal current is equal to the base current (10 milliamperes, or 7 milliamperes rms). The peak ac signal voltage is the sum of the base-to-emitter voltage across the transistor (0.4 volt as determined above), plus the voltage across  $R_B$  (0.6 volt), plus the peak ac signal voltage across  $R_1$  (1.0 milliamperes times 12 ohms, or 0.12 volt). The input voltage, therefore, is about one volt peak, or 0.7 volt rms. Thus, the total ac input power required to produce an output of 4 watts is 0.7 volt times 7 milliamperes, or 5 milliwatts, and the input impedance is 0.7 volt divided by 7 milliamperes, or 100 ohms.

Higher power output can be achieved with less distortion in class A service by the use of a **push-pull** circuit arrangement. One of the disadvantages of a transistor class A amplifier (single-ended or push-pull), however, is that collector current flows at all times. As a result, transistor dissipation is highest when no ac signal is present. This dissipation can be greatly reduced by use of class B push-pull operation. When two transistors are connected in class B push-pull, one transistor amplifies half of the signal, and the other transistor amplifies the other half. These half-signals are then combined in the output circuit to restore the original waveform in an amplified state.

Ideally, transistors used in class B service should be biased to collector cutoff so that no power is dissipated under zero-signal conditions. At low

signal inputs, however, the resulting signal would be distorted, as shown in Fig. 44, because of the low forward current-transfer ratio of the transistor at very low currents. This type of distortion, called **cross-over**

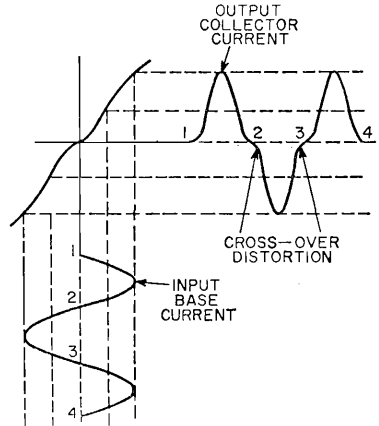

Figure 44. Waveforms showing cause of cross-over distortion.

**distortion**, can be suppressed by the use of a bias which permits a small collector current flow at zero signal level. Any residual distortion can be further reduced by the use of negative feedback.

A typical class B push-pull audio amplifier is shown in Fig. 45. Resistors  $R_{E1}$  and  $R_{E2}$  are the emitter stabilizing resistors. Resistors  $R_1$  and  $R_2$  form a voltage-divider network which provides the bias for the transistors. The base-emitter circuit is biased near collector cutoff so that very little collector power is dissipated under no-signal conditions. The characteristics of the bias network must be very carefully chosen so that the bias voltage will be just sufficient to minimize cross-over distortion at low signal levels. Because the collector current, collector dissipation, and dc operating point of a transistor vary with ambient temperature, a temperature-sensitive resistor (such as a thermistor) or a bias-compensating diode may be used in the biasing network to mini-

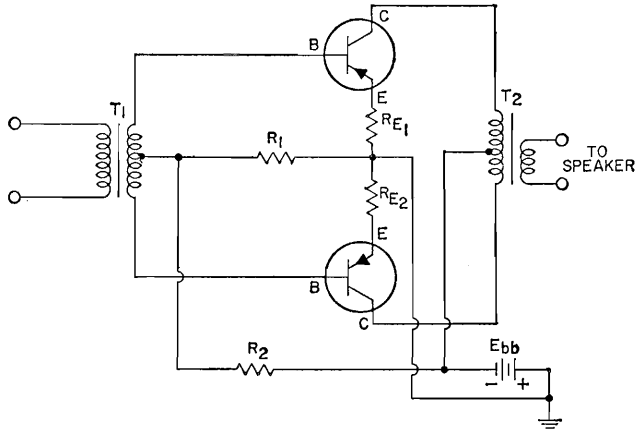

Figure 45. Class B push-pull audio-amplifier circuit.

mize the effect of temperature variations.

The advantages of class B operation can be obtained without the need for an output transformer by use of a single-ended class B circuit such as that shown in Fig. 46. In this circuit, the secondary windings of the driver transformer  $T_1$  are phased so that a positive signal from base to emitter of one transistor is accompanied by a negative signal from base to emitter of the other transistor. When a positive signal is applied to the base of transistor  $Q_1$ , for example,  $Q_1$  draws current. This current must flow through the speaker because the accompanying negative signal on the base of transistor  $Q_2$  cuts  $Q_2$  off. When the signal polarity reverses, transistor  $Q_1$

is cut off, while  $Q_2$  conducts current. The resistive dividers  $R_1R_2$  and  $R_3R_4$  provide a dc bias which keeps the transistors slightly above cutoff under no-signal conditions and thus minimizes cross-over distortion. The emitter resistors  $R_{E1}$  and  $R_{E2}$  help to compensate for differences between transistors and for the effects of ambient-temperature variations.

The secondary windings of any class B driver transformer should be bifilar-wound (i.e., wound together) to obtain tighter coupling and thereby minimize leakage inductance. Otherwise, "ringing" may occur in the cross-over region as a result of the energy stored in the leakage inductance.

Because junction transistors can be made in both p-n-p and n-p-n

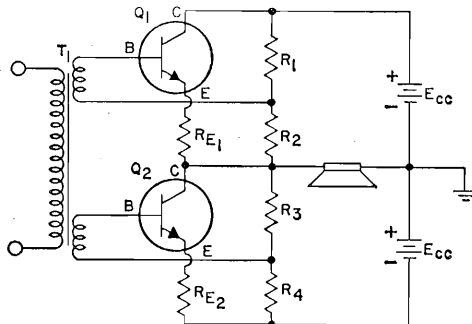

Figure 46. Single-ended class B circuit.

types, they can be used in **complementary-symmetry** circuits to obtain all the advantages of conventional push-pull amplifiers plus direct coupling. The arrows in Fig. 47 indicate the direction of electron current flow

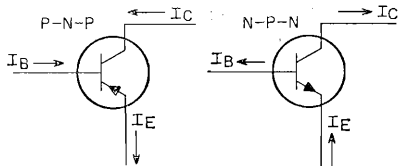

Figure 47. Electron-current flow in p-n-p and n-p-n transistors.

in the terminal leads of p-n-p and n-p-n transistors. When these two transistors are connected in a single stage, as shown in Fig. 48, the dc electron current path in the output circuit is completed through the collector-emitter circuits of the transistors. In the circuits of Figs. 45

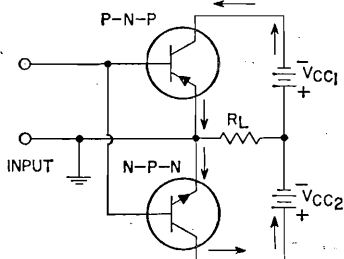

Figure 48. Basic complementary-symmetry circuit.

and 48, essentially no dc current flows through the load resistor  $R_L$ . Therefore, the voice coil of a loud-speaker can be connected directly in place of  $R_L$  without excessive speaker cone distortion.

A **phase inverter** is a type of class A amplifier used when two out-of-phase outputs are required. In the split-load phase-inverter stage shown in Fig. 49, the output current of transistor  $Q_1$  flows through both the collector load resistor  $R_4$  and the emitter load resistor  $R_3$ . When the input signal is negative, the increased output current causes the collector side of resistor  $R_4$  to become more positive and the emitter

side of resistor  $R_3$  to become more negative with respect to ground. When the input signal is positive, the output current decreases and opposite voltage polarities are established across resistors  $R_3$  and  $R_4$ . Thus, two output signals are produced which are 180 degrees out of phase with each other. This circuit provides the 180-degree phase relationship only when each load is resistive throughout the entire signal swing. It is not suitable, therefore, as a driver stage for a class B output stage.

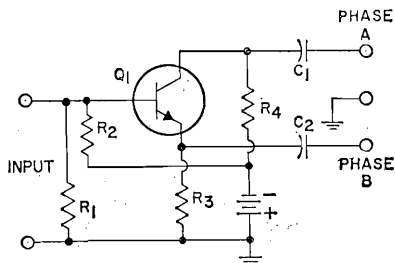

Figure 49. Split-load phase-inverter stage.

### Tuned Amplifiers

In transistor radio-frequency (rf) and intermediate-frequency (if) amplifiers, the bandwidth of frequencies to be amplified is usually only a small percentage of the center frequency. Tuned amplifiers are used in these applications to select the desired bandwidth of frequencies and to suppress unwanted frequencies. The selectivity of the amplifier is obtained by means of tuned inter-stage coupling networks.

The properties of tuned amplifiers depend upon the characteristics of **resonant circuits**. A simple parallel resonant circuit (sometimes called a "tank" because it stores energy) is shown in Fig. 50. For practical purposes, the resonant frequency of such a circuit may be considered independent of the resistance  $R$ , provided  $R$  is small compared to the inductive reactance  $X_L$ . The resonant frequency  $f_r$  is then given by

$$f_r = \frac{1}{2\pi\sqrt{LC}}$$

For any given resonant frequency, the product of L and C is a constant; at low frequencies LC is large; at high frequencies it is small.

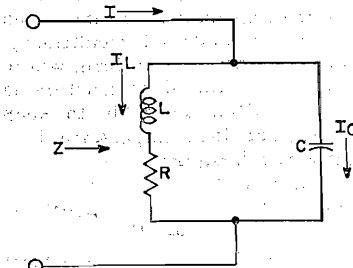

Figure 50. Simple parallel resonant circuit.

The Q (selectivity) of a parallel resonant circuit alone is the ratio of the current in the tank ( $I_L$  or  $I_C$ ) to the current in the line ( $I$ ). This unloaded Q, or  $Q_o$ , may be expressed in various ways, for example:

$$Q_o = \frac{I_C}{I} = \frac{X_L}{R} = \frac{Z}{X_C}$$

where  $X_L$  is the inductive reactance ( $= 2\pi fL$ ),  $X_C$  is the capacitive reactance ( $= 1/[2\pi fC]$ ), and Z is the total impedance of the parallel resonant circuit (tank). The Q varies inversely with the resistance of the inductor. The lower the resistance, the higher the Q and the greater the difference between the tank impedance at frequencies off resonance compared to the tank impedance at the resonant frequency.

The Q of a tuned interstage coupling network also depends upon the impedances of the preceding and following stages. The output impedance of a transistor can be considered as consisting of a resistance  $R_o$  in par-

allel with a capacitance  $C_o$ , as shown in Fig. 51. Similarly, the input impedance can be considered as consisting of a resistance  $R_i$  in parallel with a capacitance  $C_i$ . Because the tuned circuit is shunted by both the output impedance of the preceding transistor and the input impedance of the following transistor, the effective selectivity of the circuit is the loaded Q (or  $Q_L$ ) based upon the total impedance of the coupled network, as follows:

$$Q_L = \frac{Z \text{ (total loading on coil)}}{X_L \text{ or } X_C}$$

The capacitances  $C_o$  and  $C_i$  in Fig. 51 are usually considered as part of the coupling network. For example, if the required capacitance between terminals 1 and 2 of the coupling network is calculated to be 500 picofarads and the value of  $C_o$  is 10 picofarads, a capacitor of 490 picofarads is used between terminals 1 and 2 so that the total capacitance is 500 picofarads. The same method is used to allow for the capacitance  $C_i$  at terminals 3 and 4.

When a tuned resonant circuit in the primary winding of a transformer is coupled to the nonresonant secondary winding of the transformer, as shown in Fig. 52, the effect of the input impedance of the following stage on the Q of the tuned circuit can be determined by considering the values reflected (or referred) to the primary circuit by transformer action. The reflected resistance  $r_i$  is equal to the resistance  $R_i$  in the secondary circuit times the square of the effective turns ratio between the primary and secondary windings of the transformer T:

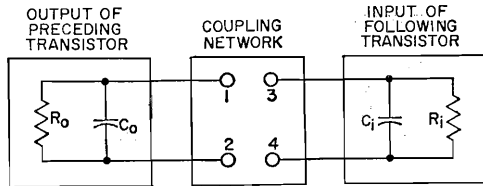

Figure 51. Equivalent output and input circuits of transistors connected by a coupling network.

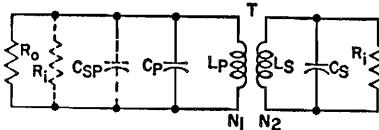

Figure 52. Equivalent circuit for transformer-coupling network having tuned primary winding.

$$r_1 = R_1 (N_1/N_2)^2$$

where  $N_1/N_2$  represents the electrical turns ratio between the primary winding and the secondary winding of T. If there is capacitance in the secondary circuit ( $C_s$ ), it is reflected to the primary circuit as a capacitance  $C_{sp}$ , and is given by

$$C_{sp} = C_p \div (N_1/N_2)^2$$

The loaded Q, or  $Q_L$ , is then calculated on the basis of the inductance  $L_p$ , the total shunt resistance ( $R_0$  plus  $r_1$  plus the tuned-circuit impedance  $Z_t = Q_0 X_c = Q_0 X_L$ ), and the total capacitance ( $C_p + C_{sp}$ ) in the tuned circuit.

Fig. 53 shows a coupling network which consists of a single-tuned circuit using magnetic or mutual inductive coupling. The capacitance  $C_t$  includes the effects of both the preceding transistor and the input capacitance of the following transistor (referred to the primary of transformer  $T_1$ ).

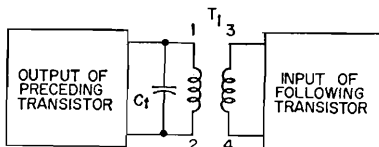

Figure 53. Single-tuned coupling network using inductive coupling.

The bandwidth, or effective frequency range, of a single-tuned transformer is determined by the half-power points on the resonance curve ( $-3$  db or 0.707 down from the maximum). Under these conditions, the band pass  $\Delta f$  is equal to the ratio of the center or resonant frequency  $f_r$  divided by the loaded (effective) Q of the circuit, as follows:

$$\Delta f = f_r/Q_L$$

The inherent internal feedback in transistors can cause instability and oscillation as the gain of an amplifier stage is increased (i.e., as the load and source impedances are increased from zero to matched conditions). At low frequencies, therefore, where the potential gain of transistors is high, it is often desirable to keep the transistor load impedance low. Relatively high capacitance values in the tuned collector circuit can then be avoided by use of a tap on the primary winding of the coupling transformer, as shown in Fig. 54. At

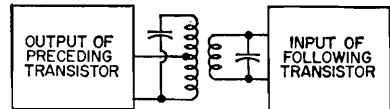

Figure 54. Transformer coupling network using tap on primary winding.

higher frequencies, the gain potential of the transistor decreases, and impedance matching is permissible.

External feedback circuits are often used in tuned coupling networks to counteract the effects of the internal transistor feedback and thus provide more gain or more stable performance. If the external feedback circuit cancels the effects of both the resistive and the reactive internal feedback, the amplifier is considered to be **unilateralized**. If the external circuit cancels the effect of only the reactive internal feedback, the amplifier is considered to be **neutralized**.

A typical tuned amplifier using neutralization is shown in Fig. 55. The input signal to the transistor is an if carrier (e.g., 455 kilocycles) amplitude-modulated by an audio signal. Capacitor  $C_1$  and the primary winding of transformer  $T_1$  form a parallel-tuned circuit resonant at 455 kilocycles. Transformer  $T_1$  couples the signal power from the previous stage to the base of the transistor. Resistor  $R_0$  provides forward bias to the transistor. Capacitor  $C_2$  provides a low-impedance path

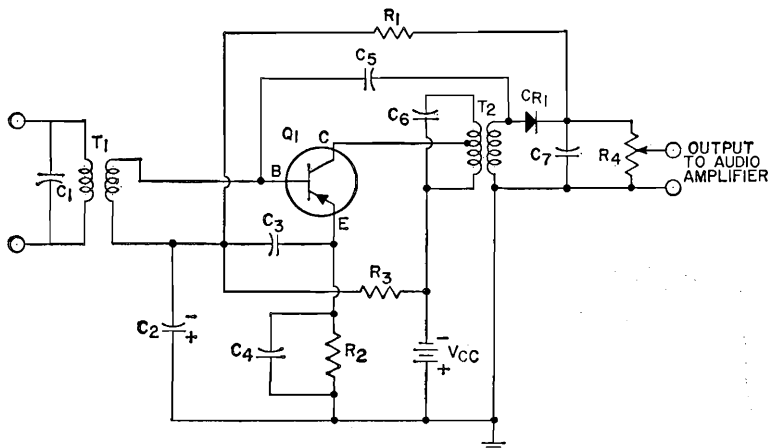

Figure 55. Neutralized if-amplifier and second-detector circuit.

for the 455-kilocycle signal from the input tuned circuit to the emitter. Resistor  $R_2$ , which is bypassed for 455 kilocycles by capacitor  $C_4$ , is the emitter dc stabilizing resistor. The amplified signal from the transistor is developed across the parallel resonant circuit (tuned to 455 kilocycles) formed by capacitor  $C_6$  and the primary winding of transformer  $T_2$ , and is coupled by  $T_2$  to the crystal-diode second detector CR.

Voltage at the intermediate frequency is taken from the secondary winding of the single-tuned output circuit and applied to the base of the transistor through the feedback (neutralizing) capacitor  $C_5$ . Because of the phase reversal in the common-emitter configuration, this external feedback is out of phase with the input from the if amplifier, and cancels the in-phase reactive feedback in the transistor due to the internal capacitance between the collector and the base.

The rectified output of the crystal diode CR is filtered by capacitor  $C_7$  and resistor  $R_4$ , so that the voltage across capacitor  $C_7$  consists of an audio signal and a dc voltage (positive with respect to ground for the arrangement shown in Fig. 55) that is directly proportional to the amplitude of the if carrier. This dc

voltage is fed back to the emitter of the transistor through the resistor  $R_1$  to provide automatic gain control. Resistor  $R_1$  and capacitor  $C_2$  form an audio decoupling network to prevent audio feedback to the base of the transistor.

Automatic gain control (agc) is often used in rf and if amplifiers in AM radio and television receivers to provide lower gain for strong signals and higher gain for weak signals. The dc component of the second-detector output, which is directly proportional to the strength of the signal carrier received, can be used to vary either the dc emitter current or the collector voltage of a transistor to provide agc. Fig. 56 shows typical curves of power gain

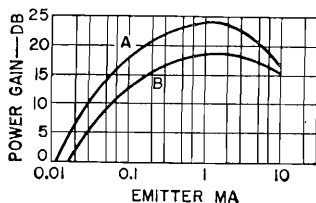

455-Kc AMPLIFIER  
COLLECTOR VOLTS = 4  
A = COMMON EMITTER  
B = COMMON BASE

Figure 56. Power gain as a function of emitter current.

as a function of emitter current for a 455-kilocycle amplifier using either common-base or common-emitter configuration.

In high-frequency tuned amplifiers, where the input impedance is typically low, mutual inductive coupling may be impracticable because of the small number of turns in the secondary winding. It is extremely difficult in practice to construct a fractional part of a turn. In such cases, capacitance coupling may be used, as shown in Fig. 57. This arrangement, which is also called **capacitive division**, is similar to tapping down on a coil near resonance. Impedance transformation in this network is determined by the ratio between capacitors  $C_1$  and  $C_2$ . Capacitor  $C_1$  is normally much smaller than  $C_2$ ; thus the capacitive reactance  $X_{C1}$  is normally much larger

both the resonant circuit in the input of the coupling network and the resonant circuit in the output are tuned to the same resonant frequency. In "stagger-tuned" networks, the two resonant circuits are tuned to slightly different resonant frequencies to provide a more rectangular band pass. Double-tuned or stagger-tuned networks may use capacitive, inductive, or mutual inductance coupling, or any combination of the three.

**Cross-modulation** is an important consideration in the evaluation of transistorized tuner circuits. This phenomenon, which occurs primarily in nonlinear systems, can be defined as the transfer of modulation from an interfering carrier to the desired carrier. In general, the value of cross-modulation is independent of both the semiconductor material and

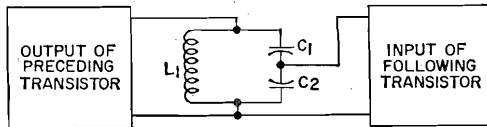

Figure 57. Single-tuned coupling network using capacitive division.

than  $X_{C2}$ . Provided the input resistance of the following transistor is much greater than  $X_{C2}$ , the effective turns ratio from the top of the coil to the input of the following transistor is  $(C_1 + C_2)/C_1$ . The total capacitance  $C_t$  across the inductance  $L$  is given by

$$C_t = \frac{C_1 C_2}{C_1 + C_2}$$

The resonant frequency  $f_r$  is then given by

$$f_r = \frac{1}{2\pi\sqrt{L_1 C_t}}$$

Double-tuned interstage coupling networks are often used in preference to single-tuned networks to provide flatter frequency response within the desired pass band and a sharper drop in response immediately adjacent to the ends of the pass band. In double-tuned networks,

the construction of the transistor. At low frequencies, cross-modulation is also independent of the amplitude of the desired carrier, but varies as the square of the amplitude of the interfering signal.

In most rf circuits, the undesirable effects of cross-modulation can be minimized by good selectivity in the antenna and rf interstage coils. Minimum cross-modulation can best be achieved by use of the optimum circuit  $Q$  with respect to bandwidth and tracking considerations, which implies minimum loading of the tank circuits.

In rf circuits where selectivity is limited by the low unloaded  $Q$ 's of the coils being used, improved cross-modulation can be obtained by mismatching the antenna circuit (that is, selecting the antenna primary-to-secondary turns ratio such that the reflected antenna impedance at the base of the rf amplifier is very



low compared to the input impedance). This technique is commonly used in automobile receivers, and causes a slight degradation in noise figure. At high frequencies, where low source impedances are difficult to obtain because of lead inductance or the impracticality of putting a tap on a coil having one or two turns, an unbypassed emitter resistor having a low value of resistance (e.g. 22 ohms) may be used to obtain the same effect.

Cross-modulation may occur in the mixer or rf amplifier, or both. Accordingly, it is important to analyze the entire tuner as well as the individual stages. Cross-modulation is also a function of agc. At low-sensitivity conditions where the rf stage is operating at maximum gain and the interfering signal is far removed from the desired signal, cross-modulation occurs primarily in the rf stage. As the desired signal level increases and reverse agc is applied to the rf stage, the rf transistor eventually becomes passive and provides improved cross-modulation. If the interfering signal is close to the desired signal, it is the rf gain at the undesired signal frequency which determines whether the rf stage or mixer stage is the prime contribution of cross-modulation. For example, at low-signal levels, it is possible that the rf stage gain (including attenuation) at the undesired frequency is greater than unity. In this case, the undesired signal at the mixer input is larger than that at the rf input; thus the contribution of the mixer is appreciable. Intermediate and high signal conditions may be analyzed similarly by considering rf agc.

### Direct-Coupled Amplifiers

Direct-coupled amplifiers are normally used in transistor circuits to amplify small dc or very-low-frequency ac signals. Typical applications of such amplifiers include the output stages of series-type and shunt-type regulating circuits,

chopper-type circuits, differential amplifiers, and pulse amplifiers.

In series regulator circuits such as that shown in Fig. 58, direct-coupled amplifiers are used to amplify an

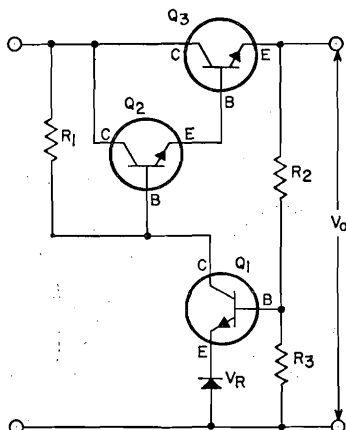

Figure 58. Typical series regulator circuit.

error or difference signal obtained from a comparison between a portion of the output voltage and a reference source. The reference-voltage source  $V_R$  is placed in the emitter circuit of the amplifier transistor  $Q_1$  so that the error or difference signal between  $V_R$  and some portion of the output voltage  $V_0$  is developed and amplified. The amplified error signal forms the input to the regulating element consisting of transistors  $Q_2$  and  $Q_3$ , and the output from the regulating element develops a controlling voltage across the resistor  $R_1$ .

Shunt regulator circuits are not as efficient as series regulator circuits for most applications, but they have the advantage of greater simplicity. In the shunt voltage regulator circuit shown in Fig. 59, the current through the shunt element consisting of transistors  $Q_1$  and  $Q_2$  varies with changes in the load current or the input voltage. This current variation is reflected across the resistance  $R_1$  in series with the load so that the output voltage  $V_0$  is maintained nearly constant.

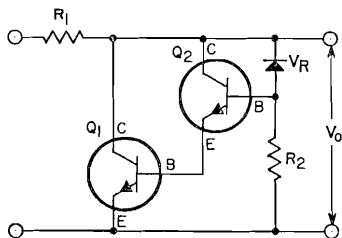

Figure 59. Typical shunt regulator circuit.

Direct-coupled amplifiers are also used in **chopper-type** circuits to amplify low-level dc signals, as illustrated by the block diagram in Fig. 60. The dc signal modulates an ac carrier wave, usually a square wave, and the modulated wave is then amplified to a convenient level. The series of amplified pulses can then be detected and integrated into the desired dc output signal.

**Differential amplifiers** can be used to provide voltage regulation, as described above, or to compensate for fluctuations in current due to signal, component, or temperature variations. Typical differential amplifier elements such as those shown in Fig. 61 include an output stage which supplies current to the load resistor  $R$ , and the necessary number of direct-coupled cascaded stages to provide the required amount of gain for a given condition of line-voltage or load-current regulation. The reference-voltage source  $V_R$  is placed in one of the cascaded stages in such a manner that an error or difference signal between  $V_R$  and some portion of the output voltage  $V_0$  is developed and amplified. Some form of temperature compensation

is usually included to insure stability of the direct-coupled amplifier.

## OSCILLATION

Transistor oscillator circuits are similar in many respects to the tuned amplifiers discussed previously, except that a portion of the output power is returned to the input network in phase with the starting power (regenerative or positive feedback) to sustain oscillation.

DC bias-voltage requirements for oscillators are similar to those discussed for amplifiers. Stabilization of the operating point is important because this point affects both the output amplitude and waveform and the frequency stability. Operation is normally maintained within the linear portion of the transistor characteristic by use of a constant supply voltage. Because the collector-to-emitter capacitance of the transistor affects frequency stability more than other parameters, a relatively large stabilizing capacitor is often used between the collector and emitter terminals to reduce the sensitivity of the circuit to voltage variations and to capacitance variations between transistors.

The maximum operating frequency of an oscillator circuit is limited by the frequency capability of the transistor used. The maximum frequency of a transistor is defined as the frequency at which the power gain is unity (i.e., an input signal appears in the output circuit at the same level, with no loss or gain). Because some power gain is required in an

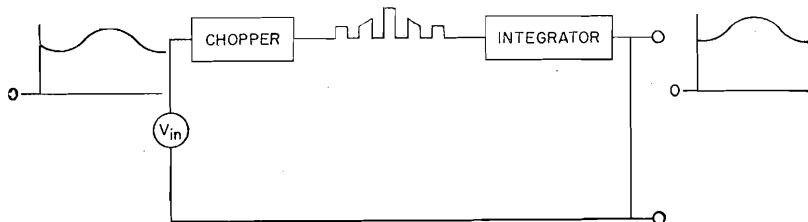

Figure 60. Block diagram showing action of "chopper" circuit.

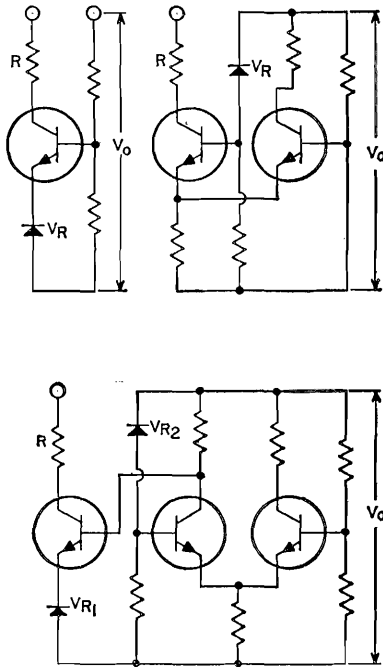

Figure 61. Typical differential amplifier circuits.

oscillator circuit to overcome losses in the feedback network, the operating frequency must be some value below the transistor maximum frequency.

The transistor configuration selected for an oscillator circuit depends on the oscillator requirements. With the common-base and common-collector configurations, the feedback network must include compensation for the difference between the input and output impedances. Phase inversion is not required, however, because no phase reversal occurs between input and output in these circuits. Voltage and power gains are greater than unity with the common-base circuit, but current gain is less than unity. Current and power gains are greater than unity with the common-collector circuit, but voltage gain is less than unity.

With the common-emitter configuration, current, voltage, and power

gains are all greater than unity. This configuration is generally desirable for use in transistor oscillators because it provides highest power gains. The input and output impedances are more closely matched than in the other configurations, but phase inversion is necessary to compensate for the 180-degree phase reversal between input and output circuits. (The phase inversion required in a common-emitter oscillator may be less than 180 degrees, depending on the operating frequency of the circuit. The transistor develops a certain amount of phase shift as the frequency increases, usually in the order of 45 degrees at the beta-cutoff frequency and about 90 degrees at the gain-bandwidth product. The feedback network is required to supply only enough phase inversion to produce a net phase shift of 360 degrees around the entire loop.)

For sustained oscillation in a transistor oscillator, the power gain of the amplifier network must be equal to or greater than unity. When the amplifier power gain becomes less than unity, oscillations become smaller with time (are "damped") until they cease to exist. In practical oscillator circuits, power gains greater than unity are required because the power output is divided between the load and the feedback network, as shown in Fig. 62. The feedback power must be equal to the input power plus the losses in the feedback network to sustain oscillation. For example, if the power gain of the transistor amplifier is 50 and the input power is 2 milliwatts, the total output power is 100 milliwatts. If the losses in the feedback network equal 20 milliwatts, the feedback power must be 2 plus 20, or 22 milliwatts. The power delivered to the load is then 100 minus 22, or 78 milliwatts.

### LC Resonant Feedback Oscillators

The frequency-determining elements of an oscillator circuit may consist of an inductance-capacitance

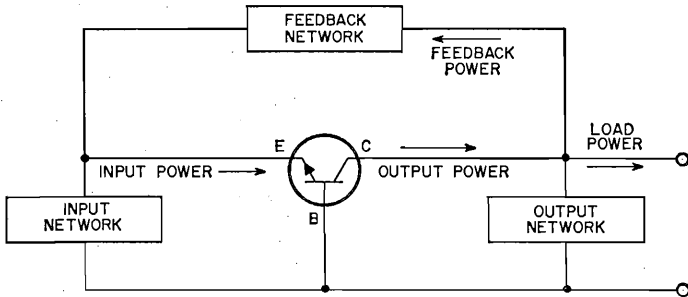

Figure 62. Block diagram of transistor oscillator showing division of output power.

(LC) network, a crystal, or a resistance-capacitance (RC) network. Fig. 63a shows a simplified diagram for a transistor oscillator which uses a "tickler" coil  $L_1$  for inductive feedback. (DC bias circuits are omitted for simplicity; as in the case of amplifiers, the emitter-base junction is forward-biased and the collector-base junction is reverse-biased.) The waveforms of ac (instantaneous) emitter current  $i_e$  and collector current  $i_c$  are shown in Fig. 63b.

When the bias conditions of the transistor are normal and input power is applied, current flow in the circuit increases (between points X and Y in Fig. 63b) as a result of the regenerative feedback coupled from the collector circuit to the emitter circuit by the transformer windings

(3-4 to 1-2). A point (Y) is reached, however, at which the collector-base junction of the transistor becomes forward-biased (the transistor is saturated), and collector current can no longer increase. The feedback current then reverses, and emitter and collector current decrease (between points Y and Z) until the emitter-base junction becomes reverse-biased (the transistor is cut off). The bias conditions then revert to their original state, and the process is repeated. The time for change from saturation to cutoff is determined primarily by the tuned circuit (tank), which, in turn, determines the frequency of oscillation.

When the common-emitter configuration is used, the tuned circuit may be placed in either the base

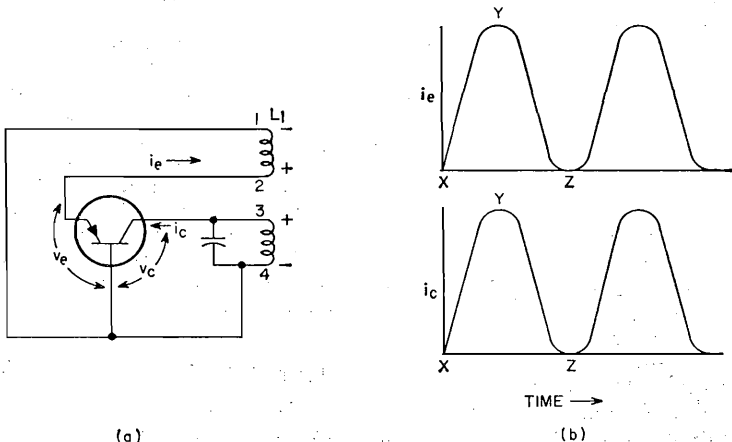

Figure 63. (a) Simplified transistor LC oscillator and (b) corresponding current waveforms.

circuit or the collector circuit. In the tuned-base oscillator shown in Fig. 64, one battery is used to provide all the dc operating voltages for the transistor. Resistors  $R_1$ ,  $R_3$ , and  $R_4$  provide the necessary bias conditions. Resistor  $R_2$  is the emitter stabilizing resistor. The components

emitter stabilizing resistor. Capacitors  $C_1$  and  $C_2$  bypass ac around resistors  $R_1$  and  $R_2$ , respectively. Although a series-feed arrangement is shown, a shunt-feed arrangement is also possible with slight circuit modifications. The shunt-feed circuit would be almost identical with the

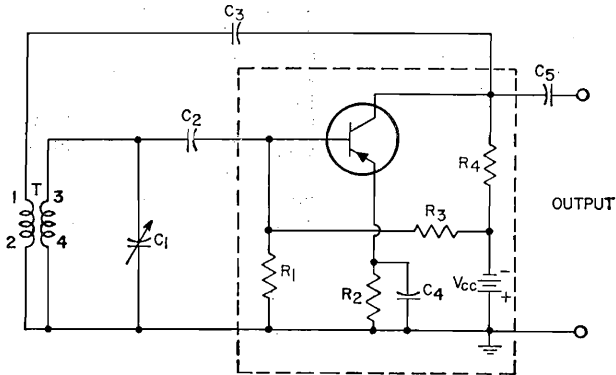

Figure 64. Tuned-base oscillator.

within the dotted lines comprise the transistor amplifier. The collector shunt-feed arrangement prevents dc current flow through the tickler (primary) winding of transformer T. Feedback is accomplished by the mutual inductance between the transformer windings.

The tank circuit consisting of the secondary winding of transformer T and variable capacitor  $C_1$  is the frequency-determining element of the oscillator. Variable capacitor  $C_1$  permits tuning through a range of frequencies. Capacitor  $C_2$  couples the oscillation signal to the base of the transistor, and also blocks dc. Capacitor  $C_4$  bypasses the ac signal around the emitter resistor  $R_2$  and prevents degeneration. The output signal is coupled from the collector through coupling capacitor  $C_5$  to the load.

A tuned-collector transistor oscillator is shown in Fig. 65. In this circuit, resistors  $R_1$  and  $R_3$  establish the base bias. Resistor  $R_2$  is the

one shown in the tuned-base oscillator in Fig. 64, except for the location of the tank circuit. The tuned circuit consists of the primary winding of transformer T and the variable capacitor  $C_3$ . Regeneration is accomplished by coupling the feedback signal from transformer winding 3-4 to the tickler coil winding

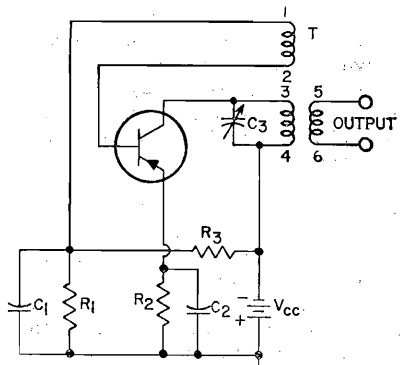

Figure 65. Tuned-collector oscillator.

1-2. The secondary winding of the transformer couples the signal output to the load.

Another form of LC resonant feedback oscillator is the transistor version of the familiar Colpitts oscillator, shown in Fig. 66. Regenera-

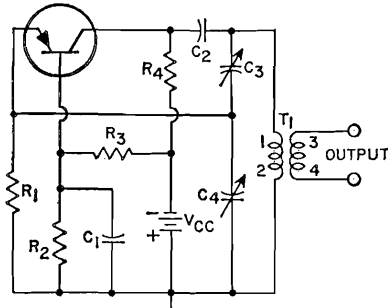

Figure 66. Transistor Colpitts oscillator.

tive feedback is obtained from the tuned circuit consisting of capacitors  $C_3$  and  $C_4$  in parallel with the primary winding of the transformer, and is applied to the emitter of the transistor. Base bias is provided by resistors  $R_2$  and  $R_3$ . Resistor  $R_4$  is the collector load resistor. Resistor  $R_1$  develops the emitter input signal and also acts as the emitter stabilizing resistor. Capacitors  $C_3$  and  $C_4$  form a voltage divider; the voltage developed across  $C_4$  is the feedback voltage. The frequency and the amount of feedback voltage can be controlled by adjustment of either or both capacitors. For minimum feedback loss, the ratio of the capacitive reactance between  $C_3$  and  $C_4$  should be approximately equal to the ratio between the output impedance and the input impedance of the transistor.

A Clapp oscillator is a modification of the Colpitts circuit shown in Fig. 66 in which a capacitor is added in series with the primary winding of the transformer to improve frequency stability. When the added capacitance is small compared to the series capacitance of  $C_3$  and  $C_4$ , the oscillator frequency is determined by the series LC combination

of the transformer primary and the added capacitor.

The Hartley oscillator shown in Fig. 67 is similar to the Colpitts oscillator, except that a split inductance is used instead of a split capacitance to obtain feedback. The circuit in Fig. 67 is modified for push-pull operation to provide greater output. The regenerative signal is applied between base and emitter of each transistor by means of the induced voltages in the transformer windings 1-3 and 4-6. After the feedback signal is applied to transformer winding 1-3, circuit operation is similar to that of a push-pull amplifier. Capacitor  $C_1$  places terminal 2 of the transformer at ac ground potential through capacitor  $C_2$ .

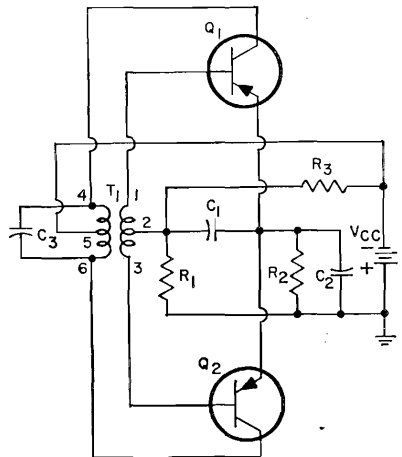

Figure 67. Hartley-type transistor push-pull oscillator.

## Crystal Oscillators

A quartz crystal is often used as the frequency-determining element in a transistor oscillator circuit because of its extremely high  $Q$  (narrow bandwidth) and good frequency stability over a given temperature range. A quartz crystal may be operated as either a series or parallel resonant circuit. As shown in Fig. 68, the electrical equivalent of the

mechanical vibrating characteristic of the crystal can be represented by a resistance  $R$ , an inductance  $L$ , and a capacitance  $C_s$  in series. The lowest impedance of the crystal occurs at the series resonant frequency of  $C_s$  and  $L$ ; the resonant frequency of the circuit is then determined only by the mechanical vibrating characteristics of the crystal.

The parallel capacitance  $C_p$ , shown in Fig. 68 represents the electrostatic capacitance between the crystal electrodes. At frequencies above the

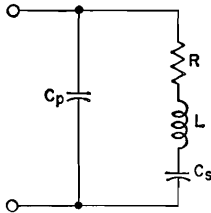

Figure 68. Equivalent circuit of quartz crystal.

series resonant frequency, the combination of  $L$  and  $C_s$  has the effect of a net inductance because the inductive reactance of  $L$  is greater than the capacitive reactance of  $C_s$ . This net inductance forms a parallel resonant circuit with  $C_p$ , and any circuit capacitance across the crystal. The impedance of the crystal is highest at the parallel resonant frequency; the resonant frequency of the circuit is then determined by both the crystal and externally connected circuit elements.

Increased frequency stability can be obtained in the tuned-collector and tuned-base oscillators discussed previously if a crystal is used in the feedback path. The oscillation frequency is then fixed by the crystal. At frequencies above and below the series resonant frequency of the crystal, the impedance of the crystal increases and the feedback is reduced. Thus, oscillation is prevented at frequencies other than the series resonant frequency.

The parallel mode of crystal resonance is used in the Pierce oscillator shown in Fig. 69. (If the crystal

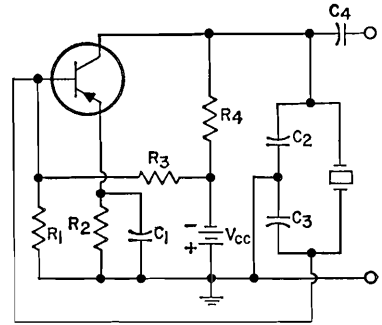

Figure 69. Pierce-type transistor crystal oscillator.

were replaced by its equivalent circuit, the functioning of the oscillator would be analogous to that of the Colpitts oscillator shown in Fig. 67.) The resistances shown in Fig. 69 provide the proper bias and stabilizing conditions for the common-emitter circuit. Capacitor  $C_1$  is the emitter bypass capacitor. The required 180-degree phase inversion of the feedback signal is accomplished through the arrangement of the voltage-divider network  $C_2$  and  $C_3$ . The connection between the capacitors is grounded so that the voltage developed across  $C_3$  is applied between base and ground and 180-degree phase reversal is obtained. The oscillating frequency of the circuit is determined by the crystal and the capacitors connected in parallel with it.

### RC Resonant Feedback Oscillators

A resistance-capacitance (RC) network is sometimes used in place of an inductance-capacitance network when phase shift is required in a transistor oscillator. In the phase-shift oscillator shown in Fig. 70, the RC network consists of three sections ( $C_1R_1$ ,  $C_2R_2$ , and  $C_3R_3$ ), each of which contributes a phase shift of 60 degrees at the frequency of oscillation. Because the capacitive reactance of the network increases or decreases at other frequencies, the 180-degree phase shift required for the common-emitter oscillator occurs only at one frequency; thus, the out-

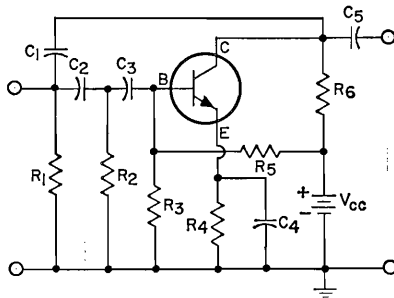

Figure 70. Transistor RC phase-shift oscillator.

put frequency of the oscillator is fixed. Phase-shift oscillators may be made variable over particular frequency ranges by the use of ganged variable capacitors or resistors in the RC networks. More than three sections may be used in the phase-shifting networks to reduce feedback losses.

An RC network is also used in the Wien-bridge oscillator shown in Fig. 71 to provide a sinusoidal output. In this circuit, transistor  $Q_2$  functions as an amplifier and phase inverter. The feedback voltage developed between the collector of  $Q_2$  and ground is impressed across the entire bridge network. The voltage developed across capacitor  $C_2$  is regenerative (positive), and is applied to the input circuit of transistor  $Q_1$ . Because this voltage is in phase with the

input signal only at the resonant frequency, the magnitude of the positive feedback is reduced at other frequencies.

Negative feedback (degeneration) is applied to the emitter of  $Q_1$  through resistor  $R_2$  to improve frequency stability and to minimize distortion.  $R_2$  normally provides greater negative feedback at frequencies other than the resonant frequency. Therefore, at other frequencies the negative feedback exceeds the positive feedback and a highly stable oscillator results.

The resonant frequency  $f_r$  of the oscillator is determined by capacitors  $C_1$  and  $C_2$  and resistors  $R_1$  and  $R_3$ , as follows:

$$f_r = \frac{1}{2\pi\sqrt{R_1 C_1 R_3 C_2}}$$

If resistor  $R_1$  is made equal to  $R_3$ , and capacitor  $C_1$  to capacitor  $C_2$ , this expression reduces to

$$f_r = \frac{1}{2\pi R_1 C_1}$$

Either capacitors  $C_1$  and  $C_2$  or resistors  $R_1$  and  $R_3$  may be made variable to provide a variable-frequency oscillator.

### Nonsinusoidal Oscillators

Oscillator circuits which produce nonsinusoidal output waveforms are

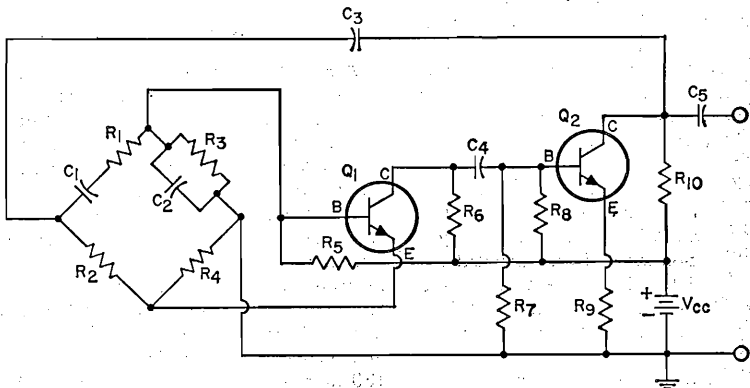

Figure 71. Wien-bridge-type transistor oscillator.



generally classified as **relaxation oscillators**. This type of oscillator uses a regenerative circuit in conjunction with resistance-capacitance (RC) or resistance-inductance (RL) components to produce a switching action. The charge and discharge times of the reactive elements ( $R \times C$  or  $L/R$ ) are used to produce sawtooth, square, or pulse output waveforms.

A **multivibrator** is essentially a nonsinusoidal two-stage oscillator in which one stage conducts while the other is cut off until a point is reached at which the conditions of the stages are reversed. This type of oscillator is normally used to produce a square-wave output. In the RC-coupled common-emitter multivibrator shown in Fig. 72, the output of transistor  $Q_1$  is coupled to the input of transistor  $Q_2$  through the feedback network  $R_3C_2$ , and the output of  $Q_2$  is coupled to the input of  $Q_1$  through the feedback network  $R_6C_3$ . Because the feedback in each case is in phase with the signal on the base electrode, oscillations can be sustained.

In the multivibrator circuit, an increase in the collector current of transistor  $Q_1$  causes a decrease in the collector voltage, and a corresponding reduction in the regenerative feedback through capacitor  $C_2$  to the base of transistor  $Q_2$ . As a result, the current through  $Q_2$  decreases

steadily as the current through  $Q_1$  increases, until a point is reached where  $Q_2$  is cut off. Capacitor  $C_2$  then discharges through resistor  $R_3$  until forward bias is reestablished across the base-emitter junction of  $Q_2$ . Current through  $Q_2$  then increases, while current through  $Q_1$  decreases until  $Q_1$  is cut off. The oscillating frequency of the multivibrator is determined by the values of resistance and capacitance in the circuit.

The output signal is coupled through capacitor  $C_5$  to the load. The output waveform, which is essentially square, may be obtained from either collector. A sawtooth output can be obtained by connection of a capacitor from collector to ground. A sinusoidal output wave can be obtained by connection of a parallel tuned circuit between the base electrodes of the two transistors.

A **blocking oscillator** is a form of nonsinusoidal oscillator which conducts for a short period of time and is cut off (blocked) for a much longer period. A basic circuit for this type of oscillator is shown in Fig. 73. Regenerative feedback through the tickler-coil winding 1-2 of transformer  $T_1$  and capacitor  $C$  causes current through the transistor to rise rapidly until saturation is reached. The transistor is then cut off until  $C$  discharges through resistor  $R$ . The output waveform is a pulse, the width

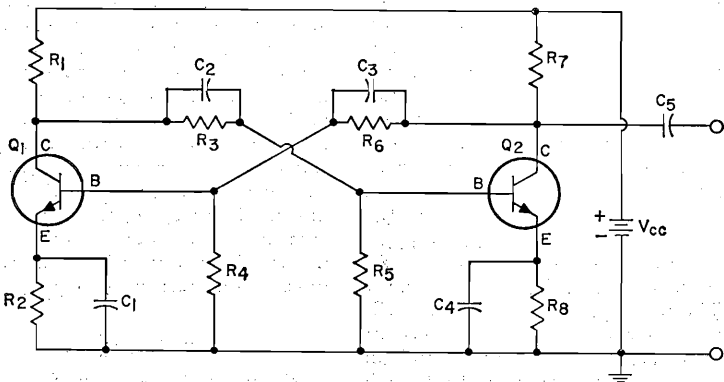

Figure 72: RC-coupled common-emitter multivibrator.

of which is primarily determined by winding 1-2. The time between pulses (resting or blocking time) is determined by the time constant of capacitor C and resistor R.

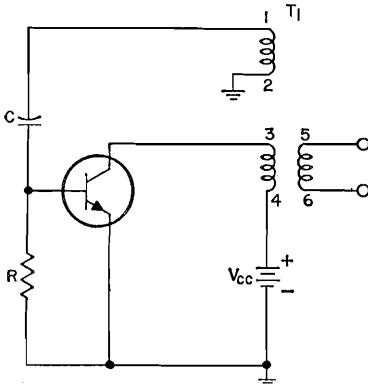

Figure 73. Basic circuit of blocking oscillator.

### SWITCHING

Transistors are often used in pulse and switching circuits in radar, television, telemetering, pulse-code communication, and computing equipment. These circuits act as generators, amplifiers, inverters, frequency dividers, and wave-shapers to provide limiting, triggering, gating, and signal-routing functions. These applications are normally characterized by large-signal or nonlinear operation of the transistor.

In large-signal operation, the transistor acts as an overdriven amplifier which is driven from the cutoff region to the saturation region. In the simple transistor-switching circuit shown in Fig. 74, the collector-base junction is reverse-biased by battery  $V_{CC}$  through resistor  $R_3$ . Switch  $S_1$  controls the polarity and amount of base current from battery  $V_{B1}$  or  $V_{B2}$ . When  $S_1$  is in the OFF position, the emitter-base junction of the transistor is reverse-biased by battery  $V_{B2}$  through the current-limiting resistor  $R_2$ . The transistor is then in the OFF (cutoff) state. (Normal quiescent conditions for a transistor switch in the cutoff region require that both junctions be reverse-biased.)

When the switch is in the ON position, forward bias is applied to the emitter-base junction by battery  $V_{B1}$  through the current-limiting resistor  $R_1$ . The base current and collector current then increase rapidly until the transistor reaches saturation. The active linear region is called the transition region in switching operation because the signal passes through this region rapidly.

In the saturation region, the collector current is usually at a maximum and collector voltage at a

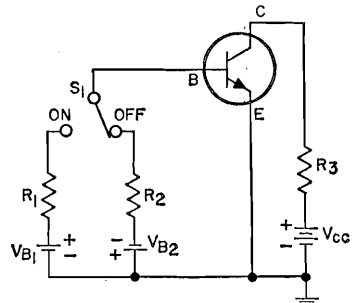

Figure 74. Simple switching circuit.

minimum. This value of collector voltage is referred to as the saturation voltage, and is an important characteristic of the transistor. A transistor operating in the saturation region is in the ON (conducting) state. (Both junctions are forward-biased.)

Regions of operation are similar for all transistor configurations used as switches. When both junctions of the transistor are reverse-biased (cutoff condition), the output current is very small and the output voltage is high. When both junctions are forward-biased (saturation condition), the output current is high and the output voltage is small. For most practical purposes, the small output current in the cutoff condition and the small output voltage in the saturated condition may be neglected.

### Switching Times

When switch  $S_1$  in Fig. 74 is operated in sequence from OFF to

ON and then back to OFF, the current pulses shown in Fig. 75 are obtained. The rectangular input current

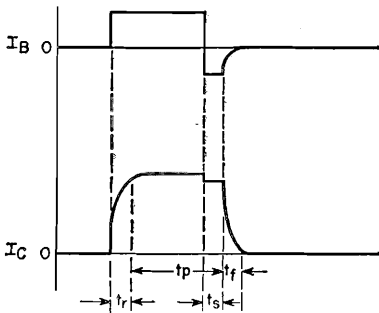

Figure 75. Current waveforms obtained in switching circuit.

pulse  $I_B$  drives the transistor from cutoff to saturation and back to cutoff. The output current pulse  $I_C$  is distorted because the transistor cannot respond instantaneously to a change in signal level. The response of the transistor during the rise time  $t_r$  and the fall time  $t_f$  is called the transient response, and is essentially determined by the transistor characteristics in the active linear region.

The delay time  $t_d$  is the length of time that the transistor remains cut off after the input pulse is applied. This finite time is required before the applied forward bias overcomes the emitter depletion capacitance of the transistor and collector current begins to flow.

The rise time  $t_r$  (which is also referred to as build up time) is the time required for the leading edge of the pulse to increase in amplitude from 10 to 90 per cent of its maximum value. Rise time can be reduced by overdriving the transistor, but only small amounts of overdrive are normally used because turn-off time (storage time plus fall time) is also affected.

The pulse time  $t_p$  (or pulse duration) is the length of time that the pulse remains at, or very near, its maximum value. Pulse time duration

is measured between the points on the leading edge and on the trailing edge where the amplitude is 90 per cent of the maximum value.

The storage time  $t_s$  is the length of time that the output current  $I_C$  remains at its maximum value after the input current  $I_B$  is reversed. The length of storage time is essentially governed by the degree of saturation into which the transistor is driven and by the amount of reverse (or turn-off) base current supplied.

The fall time  $t_f$  (or decay time) of the pulse is the time required for the trailing edge to decrease in amplitude from 90 to 10 per cent of its maximum value. Fall time may be reduced by the application of a reverse current at the end of the input pulse.

The total turn-on time of a transistor switch is the sum of the delay time and the rise time. The total turn-off time is the sum of the storage time and the fall time. A reduction in either storage time or fall time decreases turn-off time and increases the usable pulse repetition rate of the circuit.

### Triggered Circuits

When an externally applied signal is used to cause an instantaneous change in the operating state of a transistor circuit, the circuit is said to be triggered. Such circuits may be astable, monostable, or bistable. Astable triggered circuits have no stable state; they operate in the active linear region, and produce relaxation-type oscillations. A monostable circuit has one stable state in either of the stable regions (cutoff or saturation); an external pulse "triggers" the transistor to the other stable region, but the circuit then switches back to its original stable state after a period of time determined by the time constants of the circuit elements. A bistable (flip-flop) circuit has two stable states in the two stable regions. The transistor is triggered from one stable state to the other by an external pulse,

and a second trigger pulse is required to switch the circuit back to its original stable state.

The multivibrator circuit shown in Fig. 76 is an example of a monostable circuit. The bias network holds

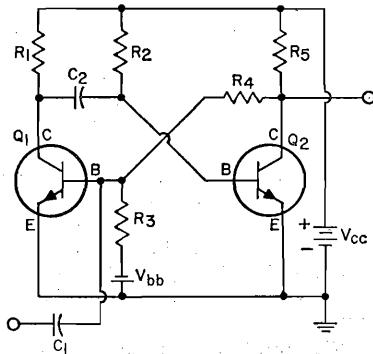

Figure 76. Monostable multivibrator.

transistor  $Q_2$  in saturation and transistor  $Q_1$  at cutoff during the quiescent or steady-state period. When an input signal is applied through the coupling capacitor  $C_1$ , however, transistor  $Q_1$  begins to conduct. The decreasing collector voltage of  $Q_1$

(coupled to the base of  $Q_2$  through capacitor  $C_2$ ) causes the base current and collector current of  $Q_2$  to decrease. The increasing collector voltage of  $Q_2$  (coupled to the base of  $Q_1$  through resistor  $R_4$ ) then increases the forward base current of  $Q_1$ . This regeneration rapidly drives transistor  $Q_1$  into saturation and transistor  $Q_2$  into cutoff. The base of transistor  $Q_2$  at this point is at a negative potential almost equal to the magnitude of the battery voltage  $V_{cc}$ .

Capacitor  $C_2$  then discharges through resistor  $R_2$  and the low saturation resistance of transistor  $Q_1$ . As the base potential of  $Q_2$  becomes slightly positive, transistor  $Q_2$  again conducts. The decreasing collector potential of  $Q_2$  is coupled to the base of  $Q_1$  and transistor  $Q_1$  is driven into cutoff, while transistor  $Q_2$  becomes saturated. This stable condition is maintained until another pulse triggers the circuit. The duration of the output pulse is primarily determined by the time constant of capacitor  $C_2$  and resistor  $R_2$  during discharge.

The Eccles-Jordan-type multivibrator circuit shown in Fig. 77 is an example of a bistable circuit. The resistive and bias values of this circuit

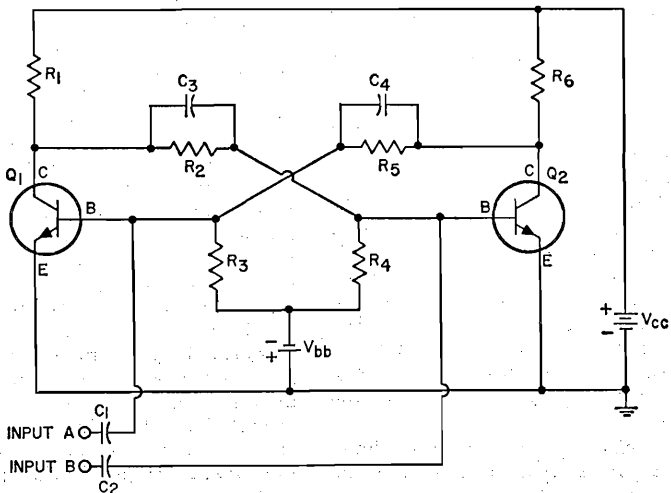

Figure 77. Eccles-Jordan-type bistable multivibrator.

are chosen so that the initial application of dc power causes one transistor to be cut off and the other to be driven into saturation. Because of the feedback arrangement, each transistor is held in its original state by the condition of the other. The application of a positive trigger pulse to the base of the OFF transistor or a negative pulse to the base of the ON transistor switches the conducting state of the circuit. The new condition is then maintained until a second pulse triggers the circuit back to the original condition.

In Fig. 77, two separate inputs are shown. A trigger pulse at input A will change the state of the circuit. An input of the same polarity at input B or an input of opposite polarity at input A will then return the circuit to its original state. (Collector triggering can be accomplished in a similar manner.) The time constants of  $C_3R_2$  and of  $C_4R_5$  essentially determine the fall time (from conduction to cutoff) of transistors  $Q_1$  and  $Q_2$ , respectively. The output of the circuit is a unit step voltage when one trigger is applied, or a square wave when continuous pulsing of the input is used.

### Gating Circuits

A transistor switching circuit in which the transistor operates as an effective open or short circuit is called a "gate". These circuits are used extensively in computer applications to provide a variety of functions such as circuit triggering at prescribed intervals and level and waveshape control. Because these cir-

cuits are designed to evaluate input conditions to provide a predetermined output, they are primarily used as logic circuits. Logic circuits include OR, AND, NOR (NOT-OR), NAND (NOT-AND), series (clamping), and shunt or inhibitor circuits.

An OR gate has more than one input, but only one output. It provides a prescribed output condition when one or another prescribed input condition exists. In the simple OR gate shown in Fig. 78, the high resistance of  $R_1$  and  $R_2$  isolates one input source from the other. When a negative input pulse is applied at either input resistor, a negative output pulse is obtained. Application of negative pulses to both inputs results only in a widening of the output pulse. If a common-emitter configuration is used instead of the common-base configuration, phase inversion of the signal results, and the OR gate becomes a NOT-OR (NOR) gate.

An AND gate also has more than one input, but only one output. However, it provides an output only when all the inputs are applied simultaneously. As in the case of the OR gate, the use of a common-emitter configuration provides phase inversion and provides a NOT-AND (NAND) gate. In the simple NAND gate shown in Fig. 79, forward (saturation) bias is provided by battery  $V_{bb}$ . The bias value is chosen so that saturating current continues to flow when only one input pulse is applied, and both input pulses are required to turn the transistor off.

The AND-OR gate shown in Fig. 80 illustrates the use of a direct-coupled transistor logic circuit to

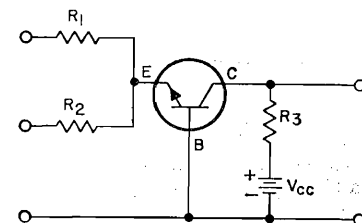

Figure 78. Simple OR-type logic circuit.

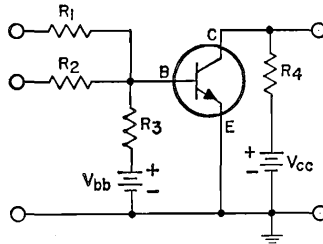

Figure 79. Simple NAND circuit.

trigger a bistable multivibrator. The over-all gating function, which consists of a NAND function and a NOR function, is performed by transistors  $Q_1$ ,  $Q_2$ , and  $Q_3$ . Transistor  $Q_4$  is part of the bistable multivibrator.

Transistors  $Q_1$  and  $Q_2$  are series-connected and form a NAND gate.

Provided all transistors are cut off (quiescent condition), triggering of the bistable multivibrator is accomplished when the prescribed input conditions for either of the NAND gates are met, i.e., when either transistors  $Q_1$  and  $Q_2$  or transistors  $Q_1$  and  $Q_3$  are triggered into conduction.

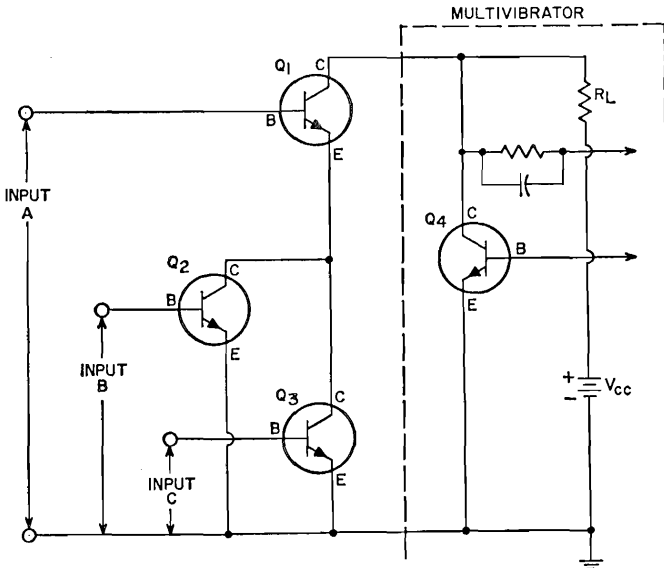

Figure 80. AND-OR gate or trigger circuit.

Similarly, transistors  $Q_1$  and  $Q_3$  are series-connected and form a NAND gate. Transistors  $Q_2$  and  $Q_3$  are parallel-connected and form a NOR gate. Reverse collector bias for all transistors is provided by battery  $V_{cc}$ .

Gating circuits are also used as amplitude discriminators (limiters), clippers, and clamping circuits, and as signal-shunting or transmission gates.

# Silicon Rectifiers

**SILICON** rectifiers, like other semiconductor diodes, are essentially cells containing a simple p-n junction. As a result, they have low resistance to current flow in one (forward) direction, but high resistance to current flow in the opposite (reverse) direction. They can be operated at ambient temperatures up to 200 degrees centigrade and at current levels as high as 40 amperes, with voltage levels as high as 1000 volts. In addition, they can be used in parallel or series arrangements to provide higher current or voltage capabilities.

Because of their high forward-to-reverse current ratios, silicon rectifiers can achieve rectification efficiencies in the order of 99 per cent. When properly used, they have excellent life characteristics which are not affected by aging, moisture, or temperature. They are very small and light-weight, and can be made impervious to shock and other severe environmental conditions.

## THERMAL CONSIDERATIONS

Although rectifiers can operate at high temperatures, they are sensitive to sudden temperature changes because of the extremely small crystals used in their structure. The thermal capacity of a silicon rectifier is quite low, and the junction temperature rises rapidly during high-current operation. Sudden rises in junction temperature caused by either high currents or excessive ambient-tem-

perature conditions can cause failure. (A silicon rectifier is considered to have failed when either the forward voltage drop or the reverse current has increased to a point where the crystal structure or surrounding material breaks down.) Consequently, temperature effects are very important in the consideration of silicon rectifier characteristics.

## REVERSE CHARACTERISTICS

When a reverse-bias voltage is applied to a silicon rectifier, a limited amount of reverse current (usually measured in microamperes, as compared to milliamperes or amperes of forward current) begins to flow. As shown in Fig. 81, this reverse current flow increases slightly as the bias voltage increases, but then tends

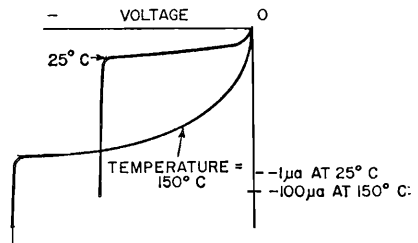

Figure 81. Typical reverse characteristics.

to remain constant even though the voltage continues to increase significantly. However, an increase in oper-

ating temperature multiplies the reverse current considerably for a given reverse bias.

At a specific reverse voltage (which varies for different types of diodes), a very sharp increase in reverse current occurs. This voltage is called the breakdown or avalanche (or zener) voltage. In many applications, rectifiers can operate safely at the avalanche point. If the reverse voltage is increased beyond this point, however, or if the ambient temperature is raised sufficiently (for example, a rise from 25 to 150 degrees centigrade increases the current by a factor of several hundred), "thermal runaway" results and the diode may be destroyed.

### FORWARD CHARACTERISTICS

A silicon rectifier usually requires a forward voltage of 0.4 to 0.7 volt (depending upon the temperature and the impurity concentration in the p-type and n-type materials) to overcome the potential barrier at the p-n junction. As shown in Fig. 82, a slight rise in voltage beyond this point increases the forward current

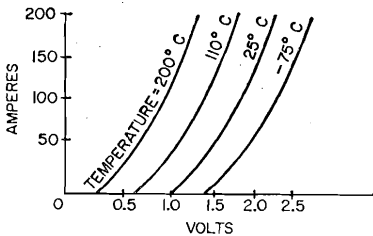

Figure 82. Typical forward characteristics.

sharply. Because of the small mass of the silicon rectifier, the forward voltage drop must be carefully controlled so that the specified maximum value for the device is not exceeded. Otherwise, the diode may be seriously damaged or destroyed.

Fig. 82 shows the effects of an increase in temperature on the forward-current characteristic of a silicon

rectifier. In certain applications, close control of ambient temperature is required for satisfactory operation. Close control is not usually required, however, in power circuits.

### RATINGS

Ratings for silicon rectifiers are determined by the manufacturer on the basis of extensive reliability testing. One of the most important ratings is the maximum **peak reverse voltage** (PRV), i.e., the highest amount of reverse voltage which can be applied to a specific rectifier before the avalanche breakdown point is reached. PRV ratings range from about 50 volts to as high as 1000 volts for some single-junction diodes. As will be discussed later, several junction diodes can be connected in series to obtain the PRV values required for very-high-voltage power-supply applications.

Three current ratings are usually given for silicon rectifiers: the **maximum average forward current**, the **peak recurrent forward current**, and the **maximum surge current**. As shown in Fig. 83, the first of these currents refers to the maximum average value of current which is allowed to flow in the forward direction for a specified ambient or case temperature. Typical average current outputs range from 0.5 ampere to as high as 40 amperes for single silicon diodes.

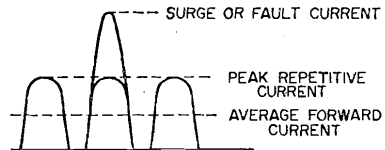

Figure 83. Representation of rectifier currents.

The peak recurrent forward current is the maximum repetitive instantaneous forward current permitted under stated conditions. The maximum surge current is the maximum non-repetitive peak current of a



single forward cycle. The surge, or fault, current is permitted for only a very short time interval (about eight milliseconds). Surge currents generally occur when the equipment is first turned on, or when unusual voltage transients are introduced in the ac supply line. Protection against excessive currents of this type can be provided in various ways, as will be discussed later.

Because these maximum current ratings are all affected by thermal variations, ambient-temperature conditions must be considered in the application of silicon rectifiers. Temperature-rating charts are usually provided to show the percentage by which maximum currents must be decreased for operation at temperatures higher than normal room temperature (25 degrees centigrade).

### HEAT SINKS

Silicon rectifiers are often mounted on devices called "heat sinks". A heat sink generally consists of a relatively large metal plate attached to the heat-conducting side of the rectifier. Because of its large surface, a heat sink can readily dissipate heat and thereby safeguard the rectifier against damage.

The size of a heat sink for a given rectifier application depends upon the ambient temperature and the maximum average forward current of the rectifier. As a result, the actual size must be calculated for each application which involves an ambient temperature or forward current other than that recommended by the manufacturer. For this calculation, two charts are used: the current-multiplying-factor chart shown in Fig. 84, and the heat-sink cooling chart shown in Fig. 85. Fig. 84 applies to all rectifier types for both polyphase and dc operation; Fig. 85 differs for different rectifier types.

The calculation requires four steps:

1. From Fig. 84, the current-multiplying factor is determined for the applicable conduction angle (i.e., the fraction of the ac input cycle during

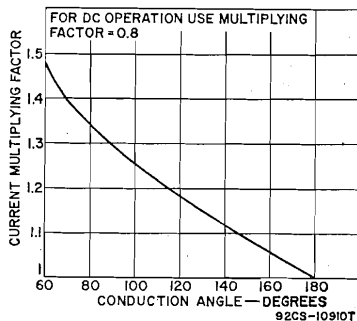

Figure 84. Current-multiplying-factor chart.

which forward current is expected to flow in the particular application). For dc operation of a silicon rectifier, a multiplying factor of 0.8 is generally specified.

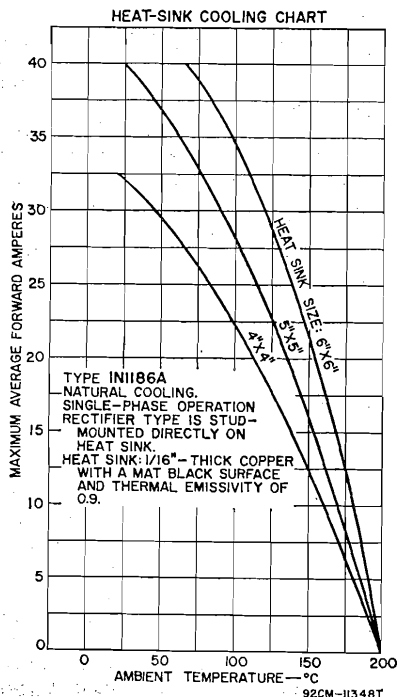

Figure 85. Typical heat-sink cooling chart.

2. The desired output current (expressed in amperes) is divided by the number of current paths. The actual number of paths depends on the type of operation intended, and can be determined from the table below.

Type of Operation	Number of Current Paths
Single-Phase, Full-Wave:	
Center-Tapped	2
Bridge	2
Three-Phase:	
Y	3
Double Y	6
Bridge	3
Six-Phase Star	6

The resulting figure is the average forward current of the rectifier.

3. The average current is then multiplied by the current-multiplying factor obtained in Step 1. The resulting figure represents the adjusted average forward current of the rectifier.

4. This adjusted current is applied to Fig. 85 to determine either the maximum allowable ambient temperature for a given heat-sink size or the minimum heat-sink size for a given ambient temperature. (Published data may also include a chart similar to Fig. 85 for forced-air-cooling applications.)

The following example illustrates the calculation of minimum heat-sink size for a three-phase, half-wave (Y) circuit. The conduction angle is 120 degrees, the desired output current is 90 amperes, and the ambient temperature is 90 degrees centigrade.

1. From Fig. 84, the current-multiplying factor for a conduction angle of 120 degrees is 1.18.

2. For three-phase half-wave operation, the number of current paths is 3. The average forward current through the rectifier, therefore, is 90 divided by 3, or 30 amperes.

3. This average forward current is then multiplied by the current-multiplying factor (1.18) obtained in Step 1 to provide an adjusted forward current of 35.4 amperes.

4. From Fig. 85, the minimum heat-sink size for the above conditions is found to be 6 by 6 inches.

## SERIES AND PARALLEL ARRANGEMENTS

Series arrangements of silicon rectifiers are used when the applied reverse voltage is expected to be greater than the maximum peak reverse voltage rating of a single silicon rectifier (or cell). For example, four rectifiers having a maximum reverse voltage rating of 200 volts each could be connected in series to handle an applied reverse voltage of 800 volts.

In a series arrangement, the most important consideration is that the applied voltage be divided equally across the individual rectifiers. If the instantaneous voltage is not uniformly divided, one of the rectifiers may be subjected to a voltage greater than its specified maximum reverse voltage, and, as a result, may be destroyed. Uniform voltage division can usually be assured by connection of either resistors or capacitors in parallel with individual cells. Shunt resistors are used in steady-state applications, and shunt capacitors in applications in which transient voltages are expected. Both resistors and capacitors should be used if the circuit is to be exposed to both dc and ac components.

A parallel arrangement of rectifiers can be used when the maximum average forward current required is larger than the maximum current rating of an individual rectifier cell. To avoid differences in voltage across the parallel rectifiers, it is desirable to add either a resistor or an inductor in series with each cell. Balanced transformers or separate transformer windings can be used for this purpose. Although resistors are considered the simplest method of current division, individual inductors in series with each cell are more efficient because they do not consume as much power as the resistor arrangement.

Parallel rectifier arrangements are not in general use. Designers normally use a polyphase arrangement to provide higher currents, or simply substitute the readily available higher-current rectifier types.

### OVERLOAD PROTECTION

In the application of silicon rectifiers, it is necessary to guard against both over-voltage and over-current (surge) conditions. A voltage surge in a rectifier arrangement can be caused by dc switching, reverse recovery transients, transformer switching, inductive-load switching, and various other causes. The effects of such surges can be reduced by the use of a capacitor connected across the input or the output of the rectifier. In addition, the magnitude of the voltage surge can be reduced by changes in the switching elements or the sequence of switching, or by a reduction in the speed of current interruption by the switching elements.

In all applications, a rectifier having a more-than-adequate peak reverse voltage rating should be used. The safety margin for reverse voltage usually depends on the application. For a single-phase half-wave application using switching of the transformer primary and having no transient suppression, a rectifier having a peak reverse voltage three or four times the expected working voltage should be used. For a full-wave bridge using load switching and having adequate suppression of transients, a margin of 1.5 to 1 is generally acceptable.

Because of the small size of the silicon rectifier, excessive surge currents are particularly harmful to rectifier operation. Current surges may be caused by short circuits, capacitor inrush, dc overload, or failure of a single cell in a multiple arrangement. In the case of low-power cells, fuses or circuit breakers are often placed in the ac input circuit to the rectifier to interrupt the fault current before it damages the rectifier. When circuit requirements are such

that service must be continued in case of failure of an individual diode, a number of cells can be used in parallel, each with its own fuse. Additional fuses should be used in the ac line and in series with the load for protection against dc load faults. In high-power cells, an arrangement of circuit breakers, fuses, and series resistances is often used to reduce the amplitude of the surge current.

### APPLICATIONS

Silicon rectifiers are used in a continually broadening range of applications. Originally developed for use in such equipment as dc-to-dc converters, battery chargers, mobile power supplies, transmitters, and electroplating devices, silicon rectifiers are also used in power supplies for radio and television receivers and phonograph amplifiers, as well as in such applications as in-line-type modulators, hold-off and charging diodes, pulse-forming networks, and brushless alternators. They are also being used in many aircraft applications because of their small size, light weight, and high efficiency.

The most suitable type of rectifier circuit for a particular application depends on the dc voltage and current requirements, the amount of rectifier "ripple" (undesired fluctuation in the dc output caused by an ac component) that can be tolerated in the circuit, and the type of ac power available. Figs. 86 through 92 show seven basic rectifier configurations. (Filters used to smooth the rectifier output are not shown for each circuit, but are discussed later.) Figs. 86 through 92 also include the output-voltage waveforms for the various circuits and the current waveforms for each individual rectifier cell in the circuits. Ideally, the voltage waveform should be as flat as possible (i.e., approaching almost pure dc). A flat curve indicates a peak-to-average voltage ratio of one. In the case of the current waveform, the smaller the current flowing through the individual rectifier, the

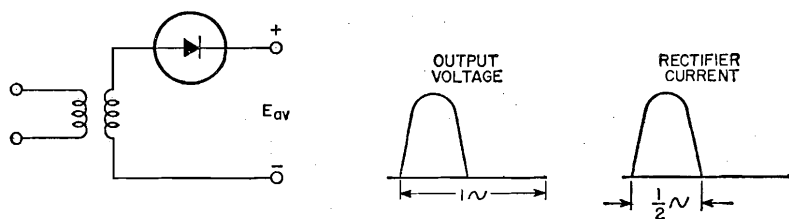

Figure 86. Single-phase half-wave circuit.

less chance there is for malfunction or burnout of the cell.

The **half-wave single-phase** circuit shown in Fig. 86 delivers only one pulse of current for each cycle of ac input voltage. As shown by the current waveform, the single rectifier cell is exposed to the entire current flow. This type of circuit, which contains a very high percentage of output ripple, is used principally in low-voltage high-current applications and in low-current high-voltage applications.

Fig. 87 shows a **single-phase full-wave** circuit with a center-tapped high-voltage winding. This circuit

exposes the individual rectifier cell to only half as much peak reverse voltage, and allows only 50 per cent of the total current to flow through each cell. This type of circuit is popular in amateur transmitter use.

The three-phase circuits shown in Figs. 89 through 92 are usually found in heavy industrial equipment such as high-power transmitters. The **three-phase (Y) half-wave** circuit shown in Fig. 89 uses three rectifier cells. This circuit has considerably less ripple than the circuits discussed above. In addition, it allows only one-third of the total current to flow

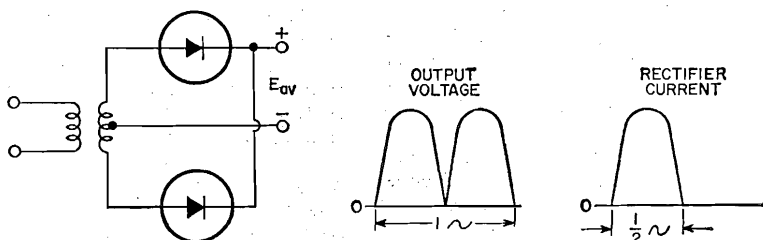

Figure 87. Single-phase full-wave circuit with center-tap.

has a higher peak-to-average voltage ratio than the circuit of Fig. 86, and about 50 per cent less ripple. This type of circuit is widely used in television receivers and large audio amplifiers.

The **single-phase full-wave bridge** circuit shown in Fig. 88 uses four rectifiers, and does not require the use of a transformer center-tap. It supplies twice as much output voltage as the circuit of Fig. 87 for the same

through each rectifier cell. This type of circuit is used in alternator rectifiers in automobiles.

Fig. 90 shows a **three-phase (Y) full-wave bridge** circuit which uses a total of six rectifier cells. In this arrangement, two half-wave rectifiers are connected in series across each leg of a high-voltage transformer. This circuit delivers twice as much voltage output as the circuit of Fig. 89 for the same voltage condi-

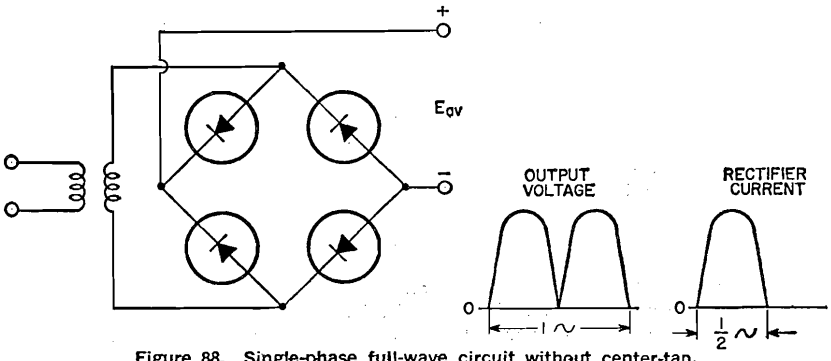

Figure 88. Single-phase full-wave circuit without center-tap.

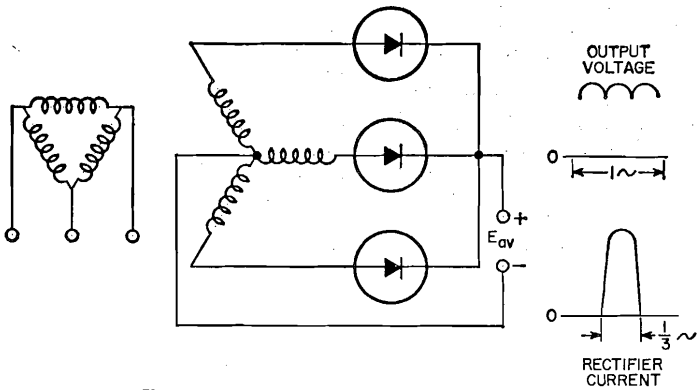

Figure 89. Three-phase (Y) half-wave circuit.

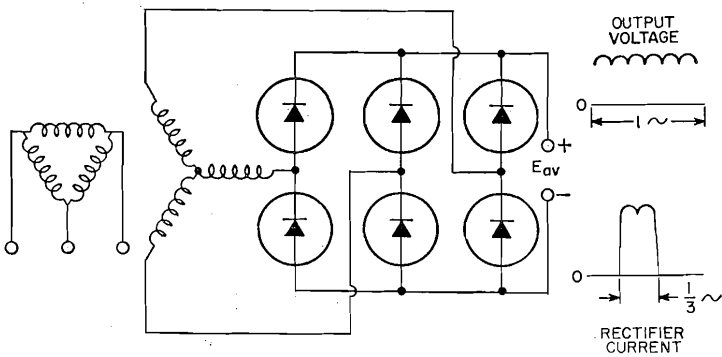

Figure 90. Three-phase (Y) full-wave bridge circuit.

tions. In addition, this circuit, as well as those shown in Figs. 91 and 92, has an extremely small percentage of ripple and a very low ratio of peak-to-average voltage.

The six-phase "star" circuit shown in Fig. 91, which also uses six rectifier cells, allows the least amount of the total current (one-sixth) to flow through each cell. The three-phase double-Y and interphase transformer circuit shown in Fig. 92 uses six half-wave rectifiers in parallel. This arrangement delivers six current pulses per cycle and twice as much output current as the circuit shown in Fig. 89.

Table I lists voltage and current ratios for the circuits shown in Figs. 86 through 92 for an inductive load. These ratios apply for sinusoidal ac input voltages. It is generally recommended that inductive loads rather than resistive loads be used for filtering of rectifier current, except for the circuit of Fig. 86. Current ratios given for inductive loads apply only when a filter choke is used be-

tween the output of the rectifier and any capacitor in the filter circuit. Values shown do not take into consideration voltage drops which occur in the power transformer, the silicon rectifiers, or the filter components under load conditions. When a particular rectifier type has been selected for use in a specific circuit, Table I can be used to determine the parameters and characteristics of the circuit.

In Table I, all ratios are shown as functions of either the average output voltage  $E_{av}$  or the average dc output current  $I_{av}$ , both of which are expressed as unity for each circuit. In practical applications, the magnitudes of these average values will, of course, vary for the different circuit configurations.

Filter circuits are generally used to smooth out the ac ripple in the output of a rectifier circuit. A smoothing filter usually consists of capacitors and iron-core chokes. In any filter-design problem, the load impedance must be considered as an

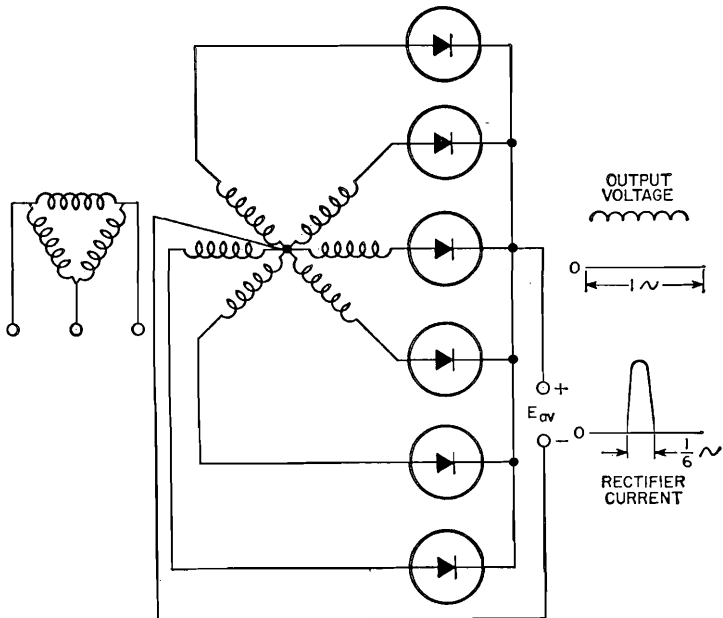

Figure 91. Six-phase "star" circuit.

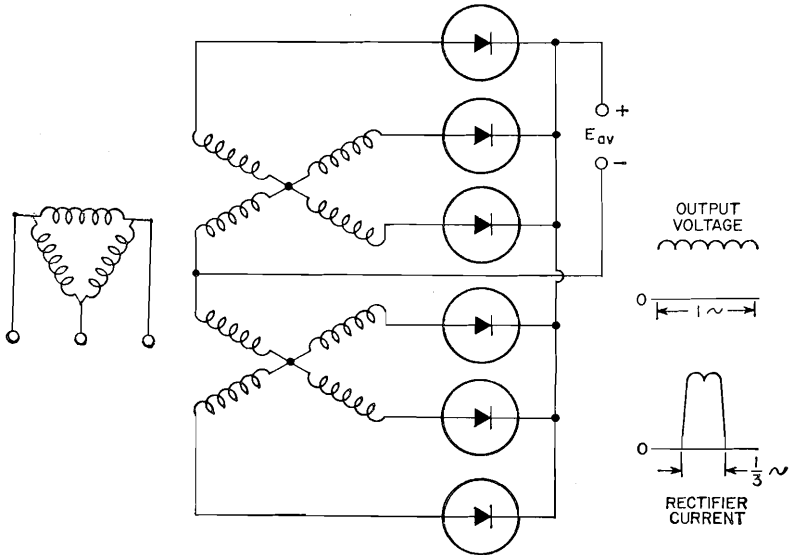

Figure 92. Three-phase double-Y and interphase transformer circuit.

integral part of the filter because the load is an important factor in filter performance. Smoothing effect is obtained from the chokes because they are in series with the load and offer a high impedance to the ripple

voltage. Smoothing effect is obtained from the capacitors because they are in parallel with the load and store energy on the voltage peaks; this energy is released on the voltage

CIRCUIT RATIOS:

	Fig. 86	Fig. 87	Fig. 88	Fig. 89	Fig. 90	Fig. 91	Fig. 92
Output Voltage							
Average . . . . .	$E_{av}$	$E_{av}$	$E_{av}$	$E_{av}$	$E_{av}$	$E_{av}$	$E_{av}$
Peak (x $E_{av}$ ) . . . . .	3.14	1.57	1.57	1.21	1.05	1.05	1.05
Ripple (%) . . . . .	121	48	48	18.3	4.3	4.3	4.3
Input Voltage (RMS)							
Phase (x $E_{av}$ ) . . . . .	2.22	1.11*	1.11	0.855*	0.428*	0.74*	0.855*
Line-to-Line (x $E_{av}$ ) . . . . .	2.22	2.22	1.11	1.48	0.74	1.48†	1.71‡
Average Output (Load) Current . . . . .	$I_{av}$	$I_{av}$	$I_{av}$	$I_{av}$	$I_{av}$	$I_{av}$	$I_{av}$
RECTIFIER CELL RATIOS							
Forward Current							
Average (x $I_{av}$ ) . . . . .	1.00	0.5	0.5	0.333	0.333	0.167	0.167
RMS (x $I_{av}$ ) . . . . .	1.57	0.785	0.785	0.587	0.579	0.409	0.293
Peak (x $I_{av}$ ) . . . . .	3.14	1.57	1.57	1.21	1.05	1.05	0.525
Peak Reverse Voltage							
x $E_{av}$ . . . . .	3.14	3.14	1.57	2.09	1.05	2.09	2.42
x $E_{rms}$ . . . . .	1.41	2.82	1.41	2.45	2.45	2.83	2.83

\* to center tap  
 • to neutral

† maximum value  
 ‡ maximum value, no load

Table 1—Voltage and current ratios for rectifier circuits shown in Figs. 86 through 92. Fig. 86 uses a resistive load, and Figs. 87 through 92 an inductive load.

dips and serves to maintain the voltage at the load substantially constant. Smoothing filters are classified as **choke-input** or **capacitor-input** according to whether a choke or capacitor is placed next to the rectifier. Typical filter circuits are shown in Fig. 93.

measured by an ac voltmeter. Filter capacitors, therefore, especially the input capacitor, should have a rating high enough to withstand the instantaneous peak value if breakdown is to be avoided. When the input-choke method is used, the available dc out-

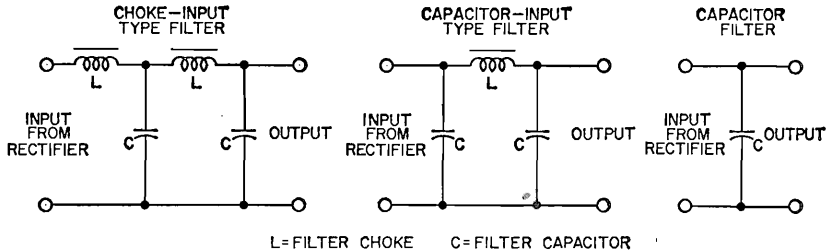

Figure 93. Typical filter circuits.

If an input capacitor is used, consideration must be given to the instantaneous peak value of the ac input voltage. This peak value is about 1.4 times the rms value as

put voltage will be somewhat lower than with the input-capacitor method for a given ac voltage. However, improved regulation together with lower peak current will be obtained.



# Silicon Controlled Rectifiers

THE silicon controlled rectifier (SCR) is basically a four-layer n-p-n-p semiconductor device having three electrodes: a cathode, an anode, and a control electrode called the gate. Like all rectifiers, it conducts current primarily in one direction. However, it differs from conventional rectifiers in that it will not conduct a substantial amount of current in the forward direction until the anode voltage exceeds a certain minimum voltage called the **forward breakover voltage**. The value of this voltage can be varied, or controlled, by the introduction of an external signal at the third electrode, or gate, of the silicon controlled rectifier. This unique control characteristic makes the silicon controlled rectifier a particularly useful switching or power-control device, especially in high-power circuits.

(The generic term **thyristor** has recently been adopted as an international standard for semiconductor devices having control characteristics similar to those of thyatron tubes. The silicon controlled rectifier belongs in this class, and is, more specifically, a **reverse-blocking triode** type of thyristor. This name will probably replace the name **silicon controlled rectifier** on a gradual basis.)

## CONSTRUCTION

Fig. 94 shows the basic construction details of the silicon controlled rectifier. The alternate layers of diffused silicon material serve as the

cathode, gate, base, and anode. These layers are enclosed in a special metal container which is then hermetically sealed to maintain an ultra-dry atmosphere. This entire unit is

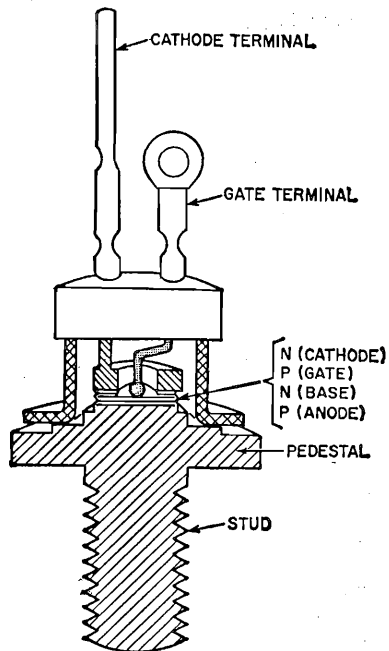

Figure 94. Construction details of typical silicon controlled rectifier.

mounted in a rugged case which provides protection against severe thermal environmental stresses. The pedestal below the semiconductor layers acts as a heat sink to help

dissipate the heat developed internally during operation.

## CURRENT-VOLTAGE CHARACTERISTICS

The voltage-current characteristic and circuit symbol of the silicon controlled rectifier are shown in Fig. 95. Under reverse-bias conditions, the device operates in a manner similar to that of conventional rectifiers, and exhibits a slight reverse leakage current which is called the **reverse blocking current** ( $I_{RBO}$ ). This current has a small value until the **peak reverse voltage** (PRV) is exceeded, at which point the reverse current increases by several orders of magnitude. The value of the peak reverse voltage differs for each individual type.

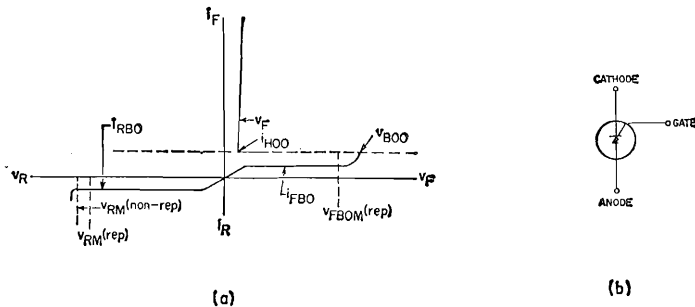

Figure 95. (a) Typical voltage and current characteristic and (b) circuit symbol for silicon controlled rectifier.

Under forward-bias conditions, there is a similar small leakage current called the **forward blocking current** ( $I_{FBO}$ ). Also, as the forward bias is increased, a voltage point is reached at which a forward break-over condition occurs and forward current increases rapidly. This point is called the **forward voltage break-over point** ( $V_{BOO}$ ).

However, when the forward current exceeds a critical value of  $V_{BOO}$ , the voltage across the device suddenly reverts back to a very low value ( $V_F$ ) with very little decrease in current. (It is assumed that the rectifier is connected to a load resistance of sufficient value to permit this "cut-back" in voltage.) When

this phenomenon occurs, the rectifier is considered to be triggered, or in the "on" condition. The forward current then continues to increase rapidly with slight increases in forward bias, and the device enters a state of high forward conduction.

It can be seen that when the forward breakover voltage of a silicon controlled rectifier is exceeded, the high internal resistance of the device changes to a very low value. The lower resistance then permits a high current to flow through the device at very low voltage values ( $V_F$ ).

This change in internal resistance makes the silicon controlled rectifier an ideal device for switching applications. When the operating voltage is below the breakover point, rectifier current is extremely small and the switch is effectively open. When

the voltage increases to a value exceeding the breakover point, the rectifier switches to its high-conduction state and the switch is closed. The silicon controlled rectifier remains in the high-conduction state until the current drops below a value which can maintain the breakover condition. This value is called the **holding current** ( $I_{HOO}$ ). When the anode-to-cathode voltage drops to a low value and reverses the current flow, the device then reverts back to the forward blocking region, and the rectifier switches to the "off" mode.

The voltage breakover point of a silicon controlled rectifier can be varied, or controlled, by injection of a signal at the gate, as indicated by

the family of curves shown in Fig. 96. When the gate current is zero, the forward voltage must reach the  $V_{BOO}$  value of the device before breakover occurs. As the gate current is increased, however, the value of break-over voltage becomes less until the curve closely resembles that of a conventional rectifier. In normal operation, silicon controlled rectifiers are operated well below the forward voltage breakover point, and a gate signal of sufficient amplitude is used to assure triggering of the rectifier to the "on" mode.

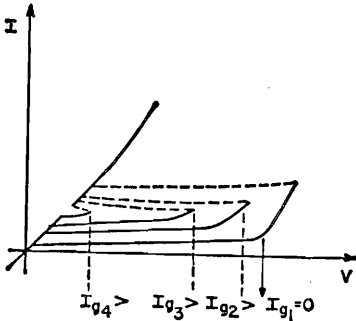

Figure 96. Family of curves with gate current at different values.

After the silicon controlled rectifier is triggered by the gate signal, the current flow through the device is independent of gate voltage or gate current. It remains in the high-conduction state until the primary or anode current is reduced to a level below that required to sustain conduction. Turnoff of the device can be achieved in minimum time by application of a reverse bias.

**MAXIMUM RATINGS**

Like other semiconductor devices, silicon controlled rectifiers must be operated within the maximum ratings specified by the manufacturer. Several voltage ratings are generally given for silicon controlled rectifiers. The **maximum peak reverse voltage** ( $V_{RM}$  (rep)) is the highest value of negative voltage which may be applied repetitively to the anode when the gate is open. The **transient peak**

**reverse voltage** ( $V_{RM}$  (non-rep)) is the maximum value of negative voltage which may be applied to the anode for not more than five milliseconds when the gate is open. The **maximum peak forward blocking voltage** ( $V_{FBOM}$ ) is the highest value of positive voltage which can be applied to the anode when the gate is open. The **maximum peak gate voltage** (forward  $V_{GKM}$  or reverse  $V_{KGM}$ ) is the highest value of voltage which may be applied between the gate and the cathode when the anode is open.

One of the more critical current ratings for silicon controlled rectifiers is the **maximum peak surge current** ( $i_{FM}$ (surge)), which is the highest permissible non-repetitive peak current of a forward cycle. This peak current may be repeated after sufficient time has elapsed for the device to return to pre-surge thermal conditions.

Also important is the **maximum average forward current** of the device. Silicon controlled rectifiers presently available have forward-current ratings ranging from less than one to more than 100 amperes. Published data for these devices usually include temperature-rating charts which indicate the percentage of current permitted as a function of temperature.

**TRIGGERING CHARACTERISTICS**

Fig. 97 shows the gate trigger-voltage characteristics for silicon controlled rectifier type 2N681. The **GATE TRIGGER-VOLTAGE CHARACTERISTICS**

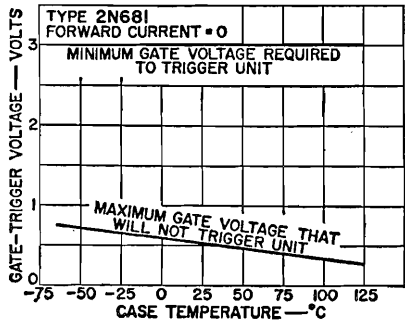

Figure 97. Triggering characteristics for 2N681.

trigger signal applied to the gate of the device must not exceed the maximum ratings of the gate, but must be sufficiently large to assure reliable triggering under all conditions.

The gate voltage of silicon controlled rectifiers during "off" periods must be below the values shown by the lower curve of Fig. 97 to prevent random triggering. Because the maximum gate voltage for "off" periods varies with temperature, a sufficiently low value must be used to prevent undesired triggering at all temperature values encountered in a particular application.

When a negative voltage is applied to the anode of a silicon controlled rectifier, the positive voltage at the gate significantly increases the reverse leakage current and, as a result, the power which must be dissipated by the device. This dissipation may be reduced by means of a "clamping" circuit in which a diode and a resistor are connected between the gate and the anode. This arrangement attenuates positive gate signals when the anode is negative. An alternative arrangement is to place a conventional rectifier having a low reverse leakage current in series with the silicon controlled rectifier. A large percentage of the negative voltage is then assumed by the diode, and reverse dissipation in the controlled rectifier is greatly reduced.

## OVERLOAD PROTECTION

In any silicon-controlled-rectifier circuit, precautions should be taken to protect the device from over-current and over-voltage surge conditions. Protection against over-current surges can be achieved by either preventing or interrupting the current surge, or by limiting the magnitude of the current flow by means of the circuit impedance. For the first approach, circuit fuses or breakers can be used effectively to disconnect the entire circuit from the power supply or to isolate the faulted silicon controlled rectifiers. In addition, dc fuses can be used to

protect the devices from dc feedback originating in the load or parallel conduction circuits. The magnitude of the over-current flow can be limited by proper selection of source and transformer impedances, as well as the inductance and reactance, of the dc circuit.

Because of the fast switching action and high commutating duty of silicon controlled rectifiers, voltage transients are more troublesome than in conventional rectifiers. In many critical applications, effective protection against voltage transients requires the use of silicon controlled rectifiers having extremely high voltage ratings or the use of two or more rectifiers in series (as described below). In less critical applications, more economical techniques are available. For example, a conventional rectifier can be used in series with the silicon controlled rectifier for protection against high voltage surges.

The effects of voltage transients in silicon-controlled-rectifier circuits can be minimized by reducing the rate at which the energy is dissipated in the devices. This "slowdown" of energy release can be achieved by relocation of the switching elements in the circuit or by a change in the sequence of switching. Other preventive methods include the change of speed of current interruption by the switching elements, or the use of an additional energy source or dissipation means in the circuit.

## SERIES ARRANGEMENT

Two or more silicon controlled rectifiers can be used in a series arrangement when the total forward (or reverse) voltage is higher than the maximum voltage rating for a single device. In series arrangements, precautions must be taken to assure equal division of the applied voltage among the devices. If one rectifier carries a larger share of voltage because of leakage differences or other variations between units, it may inadvertently fire when the peak voltage across the string

is large, and thus disrupt the entire series string. Under steady-state blocking conditions, this problem can be minimized by shunting individual rectifiers with resistors of the same value to equalize the voltage drop.

Transient effects also present a problem in series arrangements. Under high-frequency voltage-transient conditions, voltage division across the silicon controlled rectifiers becomes inversely proportional to the junction capacitance of the individual units. In this case, proper voltage division can be achieved by placing a small capacitor in parallel with each voltage-equalizing resistor, as shown in Fig. 98a. For most applications, a 0.01- to 0.05-microfarad capacitor should be sufficient.

In extremely critical applications, voltage division for a series arrangement can best be attained by replacing each voltage-equalizing resistor with a silicon voltage-reference diode, as shown in Fig. 98b.

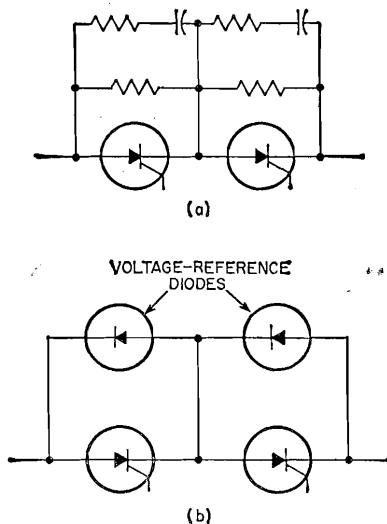

Figure 98. Various methods of proper voltage division in series arrangements.

Double-ended diodes should be used if the series string is required to block appreciable voltage in the

reverse direction as well as in the forward direction.

In series operation, the gate signal for each silicon controlled rectifier must be electrically isolated from the gate signals for all other units. Small transformers having multiple secondary windings can effectively provide such isolation for ac and pulse-type triggering circuits. In addition, a small resistor or capacitor may be placed in series with each gate to prevent controlled rectifiers having low-impedance gate characteristics from shunting the triggering signal away from units having higher gate impedance.

Although silicon controlled rectifiers can also be used in parallel arrangements, the circuit requirements in such applications are quite complicated, and require a discussion which is too detailed for the purposes of this manual.

## POWER CONTROL

As mentioned previously, silicon controlled rectifiers are used in a large number of commercial and industrial power-control applications. Fig. 99a shows a simple power-control circuit using a controlled rectifier; Fig. 99b shows the waveforms for applied voltage and load current. In this circuit, the rectifier is connected in series with the load, and the gate circuit receives its triggering signal from the pulse generator. The rectifier selected has a voltage breakover point which is higher than the value of applied peak ac anode voltage. As a result, when the gate circuit is open (i.e., no signal applied by the pulse generator), the rectifier is in the "off" condition, and no current flows through the load except a slight leakage current.

When a gate signal of sufficient amplitude is applied at the beginning of the positive anode voltage, the rectifier is triggered and current flows through the circuit for the remainder of the positive cycle, even when the triggering signal is removed. The load current ceases only when the applied ac signal becomes

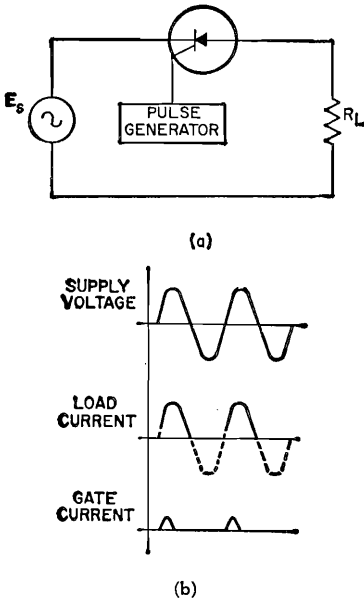

Figure 99. (a) Basic power-control circuit and (b) waveforms for supply voltage, load current, and gate current.

negative and the rectifier current falls below the value required to maintain conduction.

A silicon controlled rectifier can be used to conduct during any desired portion of the positive cycle of anode voltage by applying the gate signal at the proper value of the anode voltage. For example, if the triggering signal is applied at the positive peak of the anode voltage waveform, the rectifier conducts only a quarter of the cycle. This flexibility of control distinguishes the silicon controlled rectifier from all other types of semiconductor devices.

### CURRENT RATIOS

In the design of circuits using silicon controlled rectifiers, it is often necessary to determine the specific values of peak, average, and rms current flowing through the device. In the case of conventional rectifiers, these values are readily determined by the use of the current

ratios shown in Table I of the section on Silicon Rectifiers. For silicon controlled rectifiers, however, the calculations are more difficult because the current ratios become functions of both the conduction angle and the firing angle of the device.

The charts in Figs. 100, 101, and 102 show several current ratios as functions of conduction and firing angles for three basic silicon-controlled-rectifier circuits. These charts

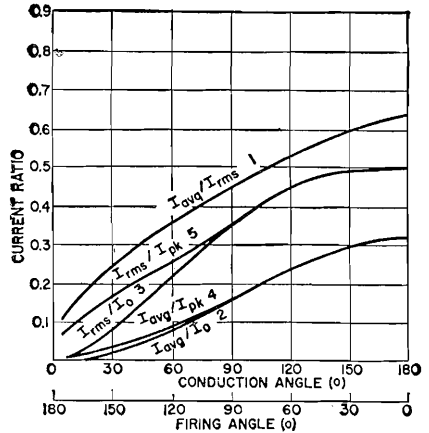

Figure 100. Ratio of device current as a function of conduction and firing angles for single-phase half-wave conduction into a resistive load.

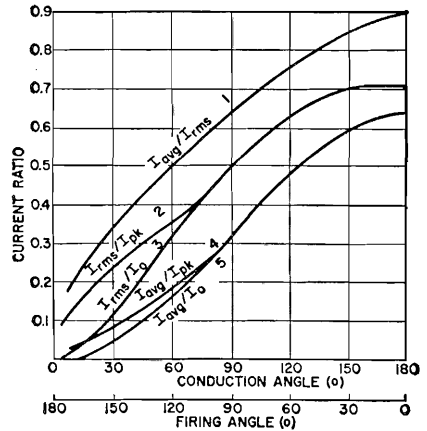

Figure 101. Ratio of device current as a function of conduction and firing angles for single-phase full-wave conduction into a resistive load.

can be used in a number of ways to calculate desired current values. For example, they can be used to determine the peak or rms current in a silicon controlled rectifier when a certain average current is to be delivered to a load during a specific part of the conduction period. It is also possible to work backwards and determine the necessary period of conduction if, for example, a specified peak-to-average current ratio must be maintained in a particular application. Another use is the calculation of the rms current at various conduction angles when it is necessary to determine the power delivered to a load, or power losses in transformers, motors, leads, or bus bars. Although the charts are presented in terms of device current, they are equally useful for the calculation of load current and voltage ratios.

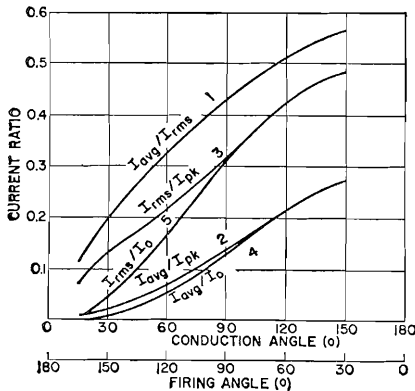

Figure 102. Ratio of device current as a function of conduction and firing angles for three-phase half-wave circuit having a resistive load.

The charts provide ratios relating average current  $I_{avg}$ , rms current  $I_{rms}$ , peak current  $I_{pk}$ , and a parameter  $I_o$  called the reference current. This last value represents a constant of the circuit, and is equal to the peak source voltage  $V_{pk}$  divided by the load resistance  $R_L$ . The term  $I_{pk}$  refers to the peak current which appears at the controlled rectifier during its period of forward conduction.  $I_o$  is the maximum value

that the current can obtain and corresponds to the peak of the sine wave. For conduction angles greater than 90 degrees,  $I_{pk}$  is equal to  $I_o$ ; for conduction angles smaller than 90 degrees,  $I_{pk}$  is smaller than  $I_o$ .

The general procedure for the use of the charts is as follows:

- (1) Identify the unknown or desired parameter.
- (2) Determine the values of the parameters fixed by the circuit specifications.
- (3) Use the appropriate curve to find the unknown quantity as a function of two of the fixed parameters.

**Example No. 1:** In the single-phase half-wave circuit shown in Fig. 103, a 2N685 silicon controlled rectifier is used to control power from a sinusoidal ac source of 120 volts rms (170 volts peak) into a 2.8-ohm load. This application requires a load current which can be varied from 2 to 25 amperes rms. It is necessary to determine the range of conduction angles required to obtain this range of load current.

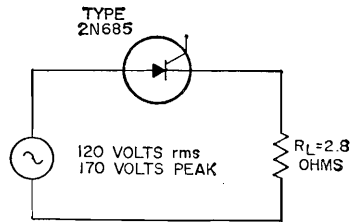

$$\begin{aligned}
 I &= 0 \quad (0^\circ \leq \theta \leq \theta_f) \\
 I &= I_o \sin \theta \quad (\theta_f \leq \theta \leq 180^\circ) \\
 I_{avg} &= \frac{1}{2\pi} \int_{\theta_f}^{180^\circ} I d\theta \\
 I_{rms} &= \left[ \frac{1}{2\pi} \int_{\theta_f}^{180^\circ} I^2 d\theta \right]^{1/2} \\
 I_{pk} &= I_o \quad (0 \geq \theta_f \geq 90^\circ) \\
 I_{pk} &= I_o \sin \theta_f \quad (90^\circ \leq \theta_f \leq 180^\circ)
 \end{aligned}$$

Figure 103. Single-phase half-wave circuit using resistive load, and respective equations for device current.

First, the reference current  $I_o$  is calculated, as follows:

$$I_o = \frac{V_{pk}}{R_L} = \frac{170}{2.8} = 61 \text{ amperes}$$

The ratios of  $I_{rms}/I_o$  for the maximum and minimum load-current values are then calculated, as follows:

$$\left[ \frac{I_{rms}}{I_o} \right] \min = \frac{2}{61} = 0.033$$

$$\left[ \frac{I_{rms}}{I_o} \right] \max = \frac{25}{61} = 0.41$$

These current-ratio values are then applied to curve 3 of Fig. 100, and the corresponding conduction angles are determined to be

$$(\theta_c) \min = 15 \text{ degrees}$$

$$(\theta_c) \max = 106 \text{ degrees}$$

**Example No. 2:** In the single-phase full-wave bridge circuit (two legs controlled) shown in Fig. 104, a constant average load current of seven amperes is to be maintained while the load resistance varies from 0.2 to 4 ohms. In this case, it is necessary to determine the variation

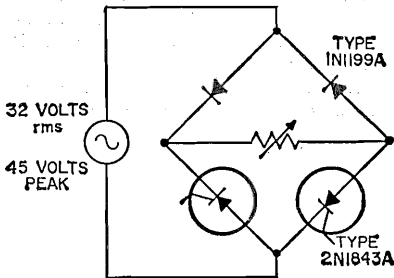

$$I = I_o \sin \theta \quad (0^\circ \leq \theta \leq 180^\circ)$$

$$I_{avg} = \frac{1}{\pi} \int_{\theta_f}^{180^\circ} I_o \sin \theta \, d\theta$$

$$I_{rms} = \left[ \frac{1}{\pi} \int_{\theta_f}^{180^\circ} I_o^2 \sin^2 \theta \, d\theta \right]^{1/2}$$

$$I_{pk} = I_o \quad (0^\circ \leq \theta_f \leq 90^\circ)$$

$$I_{pk} = I_o \sin \theta_f \quad (90^\circ \leq \theta_f \leq 180^\circ)$$

Figure 104. Single-phase full-wave bridge circuit using resistive load, and respective equations for device current.

required in the conduction angle. The average silicon controlled rectifier current is half the load current, or 3.5 amperes. The applicable current ratios for this circuit are shown in Fig. 100 (the individual device currents are half-wave although the load current is full-wave).

Again, the first quantity to be calculated is the reference current. Because the reference current varies with the load resistance, the maximum and minimum values are determined as follows:

$$(I_o) \max = \frac{V_{pk}}{(R_L) \min}$$

$$= \frac{45}{0.2} = 225 \text{ amperes}$$

$$(I_o) \min = \frac{V_{pk}}{(R_L) \max}$$

$$= \frac{45}{4} = 11.2 \text{ amperes}$$

The corresponding ratios of  $I_{avg}/I_o$  are then calculated, as follows:

$$\left[ \frac{I_{avg}}{I_o} \right] \min = \frac{3.5}{225} = 0.015$$

$$\left[ \frac{I_{avg}}{I_o} \right] \max = \frac{3.5}{11.2} = 0.312$$

Finally, these ratios are applied to curve 2 of Fig. 100 to determine the desired conduction values, as follows:

$$(\theta_c) \min = 25 \text{ degrees}$$

$$(\theta_c) \max = 165 \text{ degrees}$$

**Example No. 3:** In the three-phase half-wave circuit shown in Fig. 105, the firing angle is varied continuously from 30 to 155 degrees. In this case, it is necessary to determine the resultant variation in the attainable load power. Reference current for this circuit is determined as follows:

$$I_o = \frac{V_{pk}}{R_L} = \frac{85}{3.0} = 28 \text{ amperes}$$

Rectifier current ratios are determined from Fig. 102 for the extremes of the firing range, as follows:

$$\theta_f = 30^\circ; \frac{I_{rms}}{I_o} = 0.49$$

$$\theta_f = 155^\circ; \frac{I_{rms}}{I_o} = 0.06$$



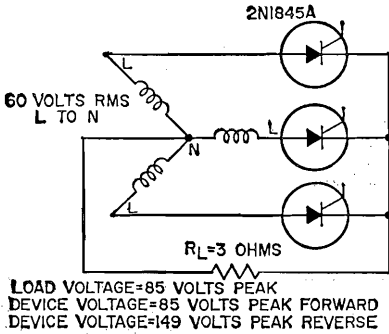

$$I = I_o \sin \theta \quad (30^\circ \leq \theta \leq 180^\circ)$$

$$I_{avg} = \frac{1}{2\pi} \int_{\theta_f}^{\theta_f + 120} I_d d\theta \quad (30^\circ \leq \theta_f \leq 60^\circ)$$

$$I_{avg} = \frac{1}{2\pi} \int_{\theta_f}^{\theta_f + 180} I_d d\theta \quad (60^\circ \leq \theta_f \leq 180^\circ)$$

$$I_{rms} = \left[ \frac{1}{2\pi} \int_{\theta_f}^{\theta_f + 120} I_d^2 d\theta \right]^{1/2} \quad (30^\circ \leq \theta_f \leq 60^\circ)$$

$$I_{rms} = \left[ \frac{1}{2\pi} \int_{\theta_f}^{\theta_f + 180} I_d^2 d\theta \right]^{1/2} \quad (60^\circ \leq \theta_f \leq 180^\circ)$$

$$I_{pk} = I_o \quad (30^\circ \leq \theta_f \leq 90^\circ)$$

$$I_{pk} = I_o \sin \theta_f \quad (90^\circ \leq \theta_f \leq 180^\circ)$$

Figure 105. Three-phase half-wave circuit using resistive load, and respective equations for device current.

These ratios, together with the reference current, are then used to determine the range of rms current in the rectifiers, as follows:

$$(I_{rms})_{max} = 0.49 \times 28 = 13.7 \text{ amperes}$$

$$(I_{rms})_{min} = 0.06 \times 28 = 1.7 \text{ amperes}$$

In this circuit, the rms current in

the load is equal to the rms rectifier current multiplied by the square root of three; as a result, the desired power range of the load is as follows:

$$P = (I_{rms} \sqrt{3})^2 R$$

$$P_{max} = 1700 \text{ watts}$$

$$P_{min} = 26 \text{ watts}$$

# Tunnel, Varactor, and Other Diodes

## TUNNEL DIODES

A TUNNEL diode is a small p-n junction device having a very high concentration of impurities in the p-type and n-type semiconductor materials. This high impurity density makes the junction depletion region (or space-charge region) so narrow that electrical charges can transfer across the junction by a quantum-mechanical action called "tunneling". This tunneling effect provides a negative-resistance region on the characteristic curve of the device that makes it possible to achieve amplification, pulse generation, and rf-energy generation.

### Construction

The structure of a tunnel diode is extremely simple, as shown in Fig. 106. A small "dot" of highly conductive n-type (or p-type) material is alloyed to a pellet of highly conductive p-type (or n-type) material to form the semiconductor junction.

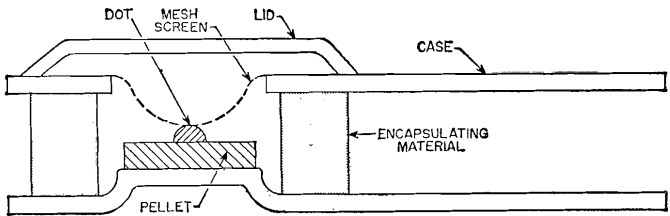

Figure 106. Structure of a tunnel diode.

The pellet (approximately 0.025 inch square) is then soldered into a low-

inductance, low-capacitance case. A very fine mesh screen is added to make the connection to the "dot". The device is then encapsulated, and a lid is welded over the cavity.

At the present time, most commercially available tunnel diodes are fabricated from either germanium or gallium arsenide. Germanium devices offer high speed, low noise, and low rise times (as low as 40 picoseconds). Gallium arsenide diodes have a voltage swing almost twice that of germanium devices, and, as a result, can provide power outputs almost four times as high. Because of their power-handling capability, gallium arsenide tunnel diodes are being used in an increasing number of applications, and appear to be particularly useful as microwave oscillators.

### Characteristics

Typical current-voltage characteristics for a tunnel diode are shown in Fig. 107. Conventional diodes do

not conduct current under conditions of reverse bias until the breakdown

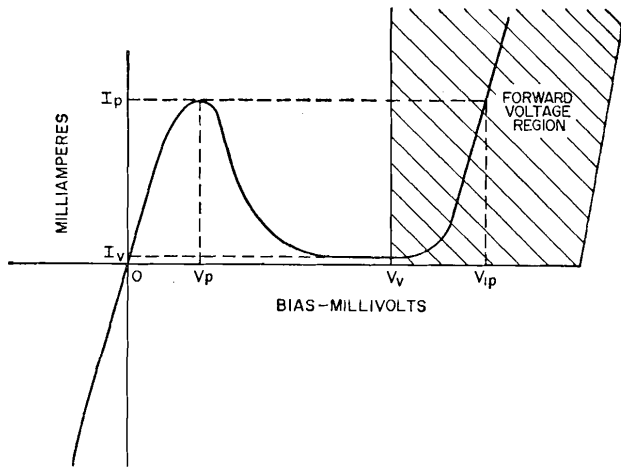

Figure 107. Typical current-voltage characteristic of a tunnel diode.

voltage is reached; under forward bias they begin to conduct at approximately 300 millivolts. In tunnel diodes, however, a small reverse bias causes the valence electrons of semiconductor atoms near the junction to “tunnel” across the junction from the p-type region into the n-type region; as a result, the tunnel diode is highly conductive for all reverse biases. Similarly, under conditions of small forward bias, the electrons in the n-type region “tunnel” across the junction to the p-type region and the tunnel-diode current rises rapidly to a sharp maximum peak  $I_p$ . At intermediate values of forward bias, the tunnel diode exhibits a negative-resistance characteristic and the current drops to a deep minimum valley point  $I_v$ . At higher values of forward bias, the tunnel diode exhibits the diode characteristic associated with conventional semiconductor current flow. The decreasing current with increasing forward bias in the negative-resistance region of the characteristic provides the tunnel diode with its ability to amplify, oscillate, and switch.

**Equivalent Circuit**

In the equivalent circuit for a tunnel diode shown in Fig. 108, the n-

type and p-type regions are shown as pure resistances  $r_1$  and  $r_2$ . The transition region is represented as a voltage-sensitive resistance  $R(v)$  in parallel with a voltage-sensitive capacitance  $C(v)$  because tunneling is

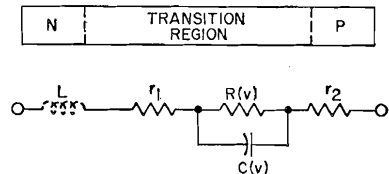

Figure 108. Equivalent circuit for a tunnel diode.

a function of both voltage and junction capacitance. This capacitance is similar to that of a parallel-plate capacitor having plates separated by the transition region.

The dashed portion  $L$  in Fig. 108 represents an inductance which results from the case and mounting of the tunnel diode. This inductance is unimportant for low-frequency diodes, but becomes increasingly important at high frequencies (above 100 megacycles).

Fig. 109 shows the form of the equivalent circuit when the diode is

biased so that its operating point is in the negative-resistance region; dynamic characteristics of tunnel diodes are defined with respect to this circuit.  $L_S$  represents the total series

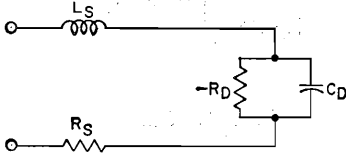

Figure 109. Equivalent circuit for a tunnel diode biased in the negative-resistance region.

inductance, and  $R_S$  the total series resistance.  $C_D$  is the capacitance and  $-R_D$  is the negative resistance of the diode. For small signal variations, both the resistance  $R_D$  and the capacitance  $C_D$  are constant.

The figure of merit  $F$  of a tunnel diode is equal to the reciprocal of  $2\pi RC$ , where  $R$  and  $C$  are the equivalent values  $-R_D$  and  $C_D$ , respectively, shown in Fig. 109. This expression has two very useful interpretations: (1) it is the diode gain-bandwidth product for circuits operating in the linear negative-resistance region of the characteristic, and (2) its reciprocal is the diode switching time when the device is used as a logic element.

### Applications

When the tunnel diode is used in circuits such as amplifiers and oscillators, the operating point must be established in the negative-resistance region. The dc load line, shown as a solid line in Fig. 110, must be very steep so that it intersects the static characteristic curve at only one point A. The ac load line can be either steep with only one intersection B, as in the case of an amplifier, or relatively flat with three intersections C, D, and E, as in the case of an oscillator. The location of the operating point is determined by the anticipated signal swing, the required signal-to-noise ratio, and the operating temperature of the device. Biasing at the center of the linear portion

of the negative-resistance slope permits the greatest signal swing. For high-temperature operation, a higher operating current is chosen; for low noise, the device is operated at the lowest possible bias current.

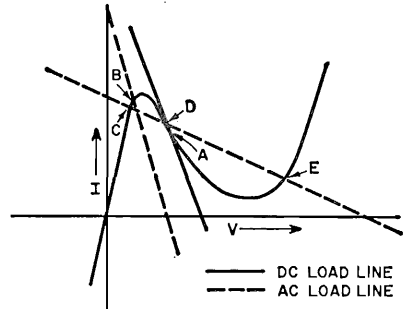

Figure 110. Typical load lines for tunnel-diode circuits.

Because tunnel diodes can operate effectively at frequencies above 300 megacycles, they are particularly suitable for use in microwave amplifiers and oscillators. In microwave amplifier circuits, tunnel diodes offer low noise, as well as small size and weight, low cost, and low power drain. In addition, bandwidths in excess of an octave can readily be obtained because of the wideband negative-resistance characteristic of tunnel diodes. However, this wideband negative resistance makes stabilization an important problem in the design of microwave tunnel-diode amplifiers.

In microwave oscillator circuits, tunnel diodes can provide useful power outputs at frequencies as high as 5000 megacycles. Compared to vacuum-tube microwave oscillators, tunnel-diode oscillators are inexpensive, require only a fraction of a volt dc bias, and are rugged and reliable in severe environments. Compared to transistor-driven varactor frequency-multiplier circuits, they are simple and compact, and afford higher dc-to-rf conversion efficiencies. (More detailed information on microwave tunnel-diode circuits, as well as on other tunnel-

diode applications, is given in the RCA TUNNEL-DIODE MANUAL TD-30.)

As a two-terminal switch, the tunnel diode is particularly suited to computer applications because of its high speed, small size, and low power consumption. Switching operation is obtained by the use of a load line which intersects the diode characteristic in three points, as shown in Fig. 110; however, only points C and E are stable operating points. If the circuit is operated at point C and a positive current step of sufficient amplitude is applied, the operating point switches to point E. Correspondingly, a negative input signal switches the operating point back to point C.

An advantage of the switching mode is its nonsensitivity to the exact linearity of the negative-resistance region of the tunnel-diode characteristics. Slight irregularities in the negative characteristic have negligible effect on the switching action.

In the basic monostable circuit or "gate" shown in Fig. 111a, the static load line is determined by the resist-

ance  $R_o$  and the voltage  $V_o$ . If  $R_o$  is less than the minimum dynamic negative resistance of the diode, only a single operating point exists. The gate is stable in its low state if  $V_o$  is adjusted so that the operating point is at E. The dynamic load line is determined by the inductive time constant  $L/R_o$ . When the inductive time constant is long compared to the switching time  $t_s$ , the current in the circuit is effectively constant.

If a small step of current  $I_{in}$  is applied to the diode, the operating point switches to the high-voltage point F along the constant-current path shown by the dashed line in Fig. 111b. Removal of the input causes the operating point to move to F'. At this point, the energy stored in the inductor L must be dissipated before the circuit can return to its original operating point. As the energy in the inductor decreases, the operating point moves along the diode characteristic to the point of minimum current at G. When this point is reached, switching again occurs along a constant-current path to point H. The cycle of operation is completed by a recovery region in which the energy in the inductor builds up to its original level; during this period the operating point moves up the diode characteristic to the starting point.

Fig. 112a shows a simple tunnel-diode logic circuit. If the static operating bias is adjusted so that only one input is required to trigger the diode, an OR function is performed. If all inputs are required to trigger the diode, an AND function is performed. Because the coupling impedance is high compared to the diode impedance, the inputs can be considered as current sources during the triggering period. Fig. 112b shows the biasing for a three-input AND gate. If the operating-point bias is increased slightly, the circuit can be made to trigger on two of its inputs; the logical function performed would then be that of a "majority gate".

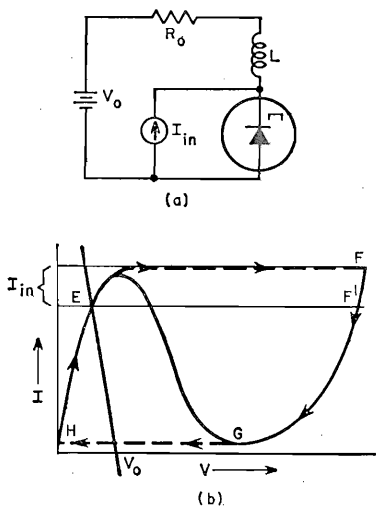

Figure 111. Basic tunnel-diode logic circuit.

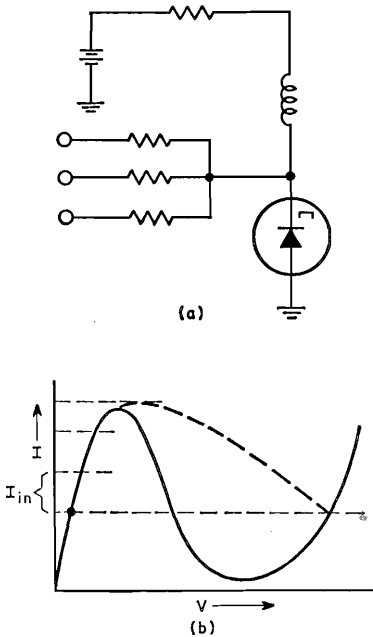

Figure 112. Tunnel-diode "AND" gate.

### Radiation and Thermal Considerations

One of the most important features of the tunnel diode is its resistance to nuclear radiation. Experimental results have shown tunnel diodes to be at least ten times more resistant to radiation than transistors. Because the resistivity of tunnel diodes is so low initially, it is not critically affected by radiation until large doses have been applied. In addition, tunnel diodes are less affected by ionizing radiation because they are relatively insensitive to surface changes produced by such radiation.

In general, the tunnel-diode voltage-current characteristic is relatively independent of temperature. Specific tunnel-diode applications may be affected, however, by the relative temperature dependence of the various circuit components. In such applications, negative feedback or direct (circuit) compensation may be required.

### HIGH-CURRENT TUNNEL DIODES

High-current tunnel diodes are basically the same as conventional tunnel diodes, except that they have a larger junction area to permit the flow of higher currents. In addition, they use a different package (RCA high-current devices generally use a rectifier package such as the DO-4 or DO-8), and have a much smaller value of series resistance (generally in the order of 0.010 ohm or less).

High-current tunnel diodes are used as low-voltage inverters in circuits having low-impedance dc power sources. They can also be used for efficient inversion of the output of solar cells, thermoelectric generators, or thermionic converters, and as overload detectors in dc and ac power supplies, pulse generators, high-speed switches, and oscillators.

Fig. 113 shows a simple overload-sensor circuit using a high-current tunnel diode. This circuit is a fast-acting sensitive overcurrent detector which can be used to protect sensitive loads from current surges or overloads. Other circuit arrangements can be used to protect the power supply rather than the load.

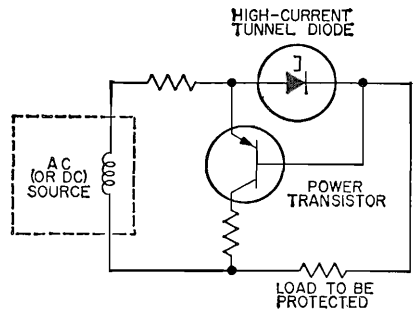

Figure 113. Overload sensor circuit using tunnel diode.

### TUNNEL RECTIFIERS

In addition to its negative-resistance properties, the tunnel diode has an efficient rectification characteristic which can be used in many rectifier applications. When a tunnel

diode is used in a circuit in such a way that this rectification property is emphasized rather than its negative-resistance characteristic, it is called a tunnel rectifier. In general, the peak current for a tunnel rectifier is less than one milliampere.

The major differences in the current-voltage characteristics of tunnel rectifiers and conventional rectifiers are shown in Fig. 114. In conventional rectifiers, current flow is substantial in the forward direction, but extremely small in the reverse direction (for signal voltages less than the breakdown voltage for the device). In tunnel rectifiers, however, substantial reverse current flows at very low voltages, while forward current is relatively small. Consequently, tunnel rectifiers can provide rectification at smaller signal voltages than conventional rectifiers, although their polarity requirements are opposite. (For this reason, tunnel rectifiers are sometimes called "back diodes.")

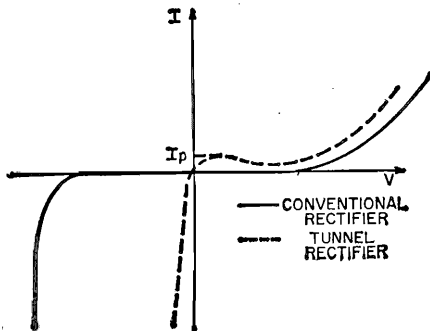

Figure 114. Current-voltage characteristics of tunnel rectifier and conventional rectifier.

Because of their high-speed capability and superior rectification characteristics, tunnel rectifiers can be used to provide coupling in one direction and isolation in the opposite direction. Fig. 115 shows the use of tunnel rectifiers to provide directional coupling in a tunnel-diode logic circuit.

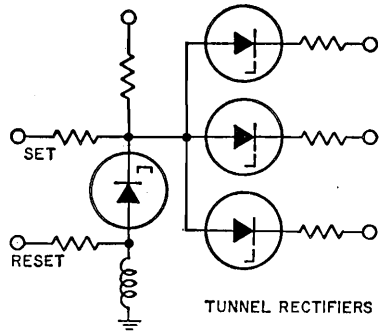

Figure 115. Logic circuit using a tunnel diode and three tunnel rectifiers.

### VARACTOR DIODES

A varactor or variable-reactance diode is a microwave-frequency p-n junction semiconductor device in which the depletion-layer capacitance bears a nonlinear relation to the junction voltage, as shown in Fig. 116a. When biased in the reverse direction, a varactor diode can be represented by a voltage-sensitive capacitance  $C(v)$  in series with a resistance  $R_s$ , as shown in Fig. 116b. This nonlinear capacitance and low series resistance, which permit the device to perform frequency-multiplication, oscillation, and switching functions, result from a very high impurity concentration

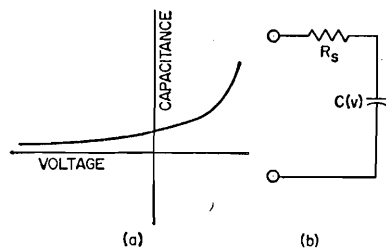

Figure 116. (a) Capacitance-voltage relationship and (b) equivalent circuits for a varactor diode.

outside the depletion-layer region and a relatively low concentration at the junction. Very low noise levels are possible in circuits using varactor diodes because the dominant current across the junction is reactive and shot-noise components are absent.

Reactive nonlinearity, without an appreciable series resistance component, enables varactor diodes to generate harmonics with very high efficiency in circuits such as the shunt-type frequency multiplier shown in Fig. 117. The circuit is driven by a sinusoidal voltage source  $V_s$  having

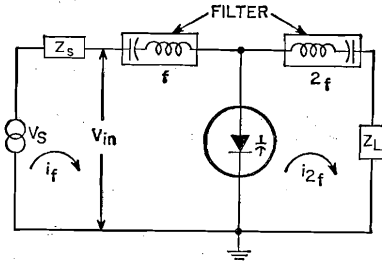

Figure 117. Varactor-diode frequency multiplier.

a fundamental frequency  $f$  and an internal impedance  $Z_s$ . Because the ideal input filter is an open circuit for all frequencies except the fundamental frequency, only the fundamental component of current  $i_f$  can flow in the input loop. A second-harmonic current  $i_{2f}$  is generated by the varactor diode and flows toward the load  $Z_L$ ; another ideal filter is used in the output loop to block the fundamental-frequency component of the input current.

Varactor diodes can amplify signals when their voltage-dependent capacitance is modulated by an alternating voltage at a different frequency. This alternating voltage supply, which is often referred to as the "pump", adds energy to the signal by changing the diode capacitance in a specific phase relation with the stored signal charge so that potential energy is added to this charge. An "idler" circuit is generally used to provide the proper phase relationship between the signal and the "pump".

### VOLTAGE-REFERENCE DIODES

Voltage-reference or zener diodes are silicon rectifiers in which the reverse current remains small until

the breakdown voltage is reached and then increases rapidly with little further increase in voltage. The breakdown voltage is a function of the diode material and construction, and can be varied from one volt to several hundred volts for various current and power ratings, depending on the junction area and the method of cooling. A stabilized supply can deliver a constant output (voltage or current) unaffected by temperature, output load, or input voltage, within given limits. The stability provided by voltage-reference diodes makes them useful as stabilizing devices and as reference sources capable of supplying extremely constant current loads.

### COMPENSATING DIODES

Excellent stabilization of collector current for variations in both supply voltage and temperature can be obtained by the use of a compensating diode operating in the forward direction in the bias network of amplifier or oscillator circuits. Fig. 118 shows the transfer characteristics of

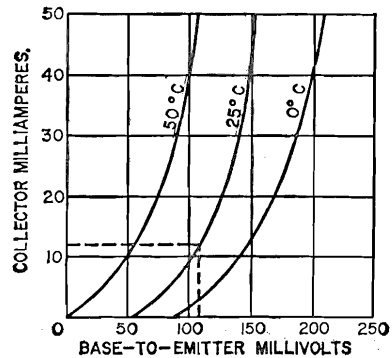

Figure 118. Transfer characteristics of transistor.

a transistor; Fig. 119 shows the forward characteristics of a compensating diode. In a typical circuit, the diode is biased in the forward direction; the operating point is represented on the diode characteristics by the dashed horizontal line. The



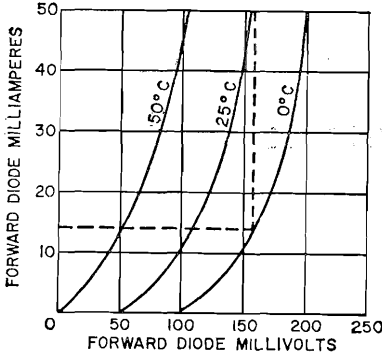

Figure 119. Forward characteristics of compensating diode.

diode current at this point determines a bias voltage which estab-

lishes the transistor idling current. This bias voltage shifts with varying temperature in the same direction and magnitude as the transistor characteristic, and thus provides an idling current that is essentially independent of temperature.

The use of a compensating diode also reduces the variation in transistor idling current as a result of supply-voltage variations. Because the diode current changes in proportion with the supply voltage, the bias voltage to the transistor changes in the same proportion and idling-current changes are minimized. (The use of diode compensation is discussed in more detail under "Biasing" in the Transistor Applications Section.)

# Transistor Installation

**T**HIS section covers installation suggestions and precautions which are generally applicable to all types of transistors. Careful observance of these suggestions will help experimenters and technicians to obtain the best results from semiconductor devices and circuits.

## ELECTRICAL CONNECTIONS

The collector, base, and emitter terminals of transistors can be connected to associated circuit elements by means of sockets, clips, or solder connections to the leads or pins. If connections are soldered close to the lead or pin seals, care must be taken to conduct excessive heat away from the seals, otherwise the heat of the soldering operation may crack the glass seals and damage the transistor. When dip soldering is employed in the assembly of printed circuits using transistors, the temperature of the solder should be limited to about 225 to 250 degrees centigrade for a maximum immersion period of 10 seconds. Furthermore, the leads should not be dip-soldered too close to the transistor case. Under no circumstances should the mounting flange of a transistor be soldered to a heat sink because the heat of the soldering operation may permanently damage the transistor.

When the metal case of a transistor is connected internally to the collector, the case operates at the collector voltage. If the case is to operate at a voltage appreciably above

or below ground potential, consideration must be given to the possibility of shock hazard and suitable precautionary measures taken.

## TESTING

A quick check can be made of transistors prior to their installation in a circuit by resistance measurements with an electronic voltmeter (such as a VoltOhmyst\*). Resistance between any two electrodes should be very high (more than 10,000 ohms) in one direction, and considerably lower in the other direction (100 ohms or less between emitter and base or collector and base; about 1000 ohms between emitter and collector). It is very important to limit the amount of voltage used in such tests (particularly between emitter and base) so that the breakdown voltages of the transistor will not be exceeded; otherwise the transistor may be damaged by excessive currents.

## TEMPERATURE EFFECTS

Many transistor characteristics are sensitive to variations in temperature, and may change enough at high operating temperatures to affect circuit performance. Fig. 120 illustrates the effect of increasing temperature on the common-emitter forward current-transfer ratio (beta), the dc collector-cutoff current, and the input and output impedances. To avoid undesired changes in circuit operation, it is recommended that tran-

\*Trade Mark Reg. U.S. Pat. Off.

sistors be located away from heat sources in equipment, and also that provisions be made for adequate heat dissipation and, if necessary, for temperature compensation.

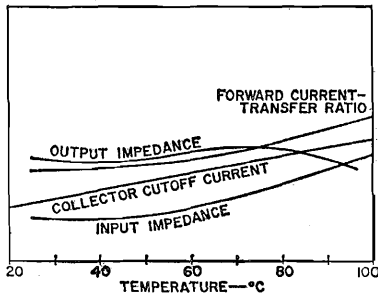

Figure 120. Variation of transistor characteristics with temperature.

HEAT SINKS

In some transistors, the collector electrode is connected internally to the metal case to improve heat-dissipation capabilities. More efficient cooling of the collector junction in these transistors can be accomplished by connection of the case to a heat sink by connection of the case to a heat sink. It is recommended that a 0.002-inch mica insulator or an anodized aluminum insulator having high thermal conductivity be used between the transistor base and the heat sink, usually the chassis. The insulator should extend beyond the mounting clamp, as shown in Fig. 121. It should be drilled or punched to provide both the two mounting holes and the clearance holes for the collector, emitter, and base pins. Burrs should be removed from both the insulator and the holes in the chassis so that the insulating layer will not be destroyed during mounting. It is also recommended that a fiber washer be used between the mounting bolt and the chassis, as shown in Fig. 121, to prevent a short circuit between them.

The use of an external resistance in the emitter or collector circuit of a transistor is an effective deterrent to damage which might be caused

by thermal runaway. The minimum value of this resistance for low-level stages may be obtained from the following equation:

$$R_{min} = \frac{E^2}{4 \left( P_0 + \frac{25}{K} \right)}$$

where E is the dc collector supply voltage in volts, P<sub>0</sub> is the product of the collector-to-emitter voltage and the collector current at the desired operating point in watts, and K is the thermal resistance of the transistor and heat sink in degrees centigrade per watt.

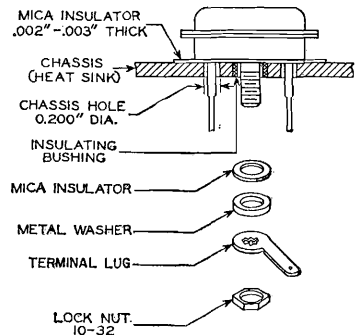

Figure 121. Suggested mounting arrangement for transistor on heat sink.

SHIELDING

In high-frequency stages having high gain, undesired feedback may occur and produce harmful effects on circuit performance unless shielding is used. The output circuit of each stage is usually shielded from the input of the stage, and each high-frequency stage is usually shielded from other high-frequency stages. It is also desirable to shield separately each unit of the high-frequency stages. For example, each if and rf coil in a superheterodyne receiver may be mounted in a separate shield can. Baffle plates may be mounted on the ganged tuning capacitor to shield each section of the capacitor from the other section.

The shielding precautions required in a circuit depend on the design of the circuit and the layout of the parts. When the metal case of a transistor is grounded at the socket terminal, the grounding connection should be as short as possible to minimize lead inductance. Many transistors have a separate lead connected to the case and used as a ground lead; where present, these leads are indicated in the terminal diagrams.

### DRESS OF CIRCUIT LEADS

At high frequencies such as are encountered in FM and television receivers, lead dress (i.e., the location and arrangement of the leads used for connections in the receiver) is very important. Because even a short lead provides a large impedance at high frequencies, it is necessary to keep all high-frequency leads as short as possible. This precaution is especially important for ground connections and for all connections to bypass capacitors and high-frequency filter capacitors. It is recommended that a common ground return be used for each stage, and that short, direct connections be made to the

common ground point. The emitter lead especially should be kept as short as possible.

Particular care should be taken with the lead dress of the input and output circuits of high-frequency stages so that the possibility of stray coupling is minimized. Unshielded leads connected to shielded components should be dressed close to the chassis.

In high-gain audio amplifiers, these same precautions should be taken to minimize the possibility of self-oscillation.

### FILTERS

Feedback effects may occur in radio or television receivers as a result of coupling between stages through common voltage-supply circuits. Filters find an important use in minimizing such effects. They should be placed in voltage-supply leads to each transistor to provide isolation between stages.

Capacitors used in transistor rf circuits, particularly at high frequencies, should be mica or ceramic. For audio bypassing, electrolytic capacitors are required.

# Interpretation of Data

**T**HE technical data for RCA transistors given in the following section include ratings, characteristics, typical operation values, and characteristic curves. Unless otherwise specified, all voltages and currents are dc values, and all values are obtained at an ambient temperature of 25 degrees centigrade.

**Ratings** are established for semiconductor devices to help equipment designers utilize the performance and service capabilities of each type to the best advantage. These ratings are based on careful study and extensive testing, and indicate limits within which the specified characteristics must be maintained to ensure satisfactory performance. The maximum ratings given for the semiconductor devices included in this Manual are based on the Absolute Maximum system. This system has been defined by the Joint Electron Device Engineering Council (JEDEC) and standardized by the National Electrical Manufacturers Association (NEMA) and the Electronic Industries Association (EIA).

Absolute-maximum ratings are limiting values of operating and environmental conditions which should not be exceeded by any device of a specified type under any condition of operation. Effective use of these ratings requires close control of supply-voltage variations, component variations, equipment-control adjustment, load variations, signal variations, and environmental conditions.

Electrode voltage and current ratings for transistors are in general self-explanatory, but a brief explanation of some ratings will aid in the understanding and interpretation of transistor data.

Voltage ratings are established with reference to a specified electrode (e.g., collector-to-emitter voltage), and indicate the maximum potential which can be placed across the two given electrodes before crystal breakdown occurs. These ratings may be specified with the third electrode open, or with specific bias voltages or external resistances.

**Transistor dissipation** is the power dissipated in the form of heat by the collector. It is the difference between the power supplied to the collector and the power delivered by the transistor to the load. Because of the sensitivity of semiconductor materials to variations in thermal conditions, maximum dissipation ratings are usually given for specific temperature conditions.

For many types, the maximum value of transistor dissipation is specified for ambient, case, or mounting-flange temperatures up to 25 degrees centigrade, and must be reduced linearly for higher temperatures. For such types, Fig. 122 can be used to determine maximum permissible dissipation values at particular temperature conditions above 25 degrees centigrade. (This figure cannot be assumed to apply to types other than those for which it is specified in the

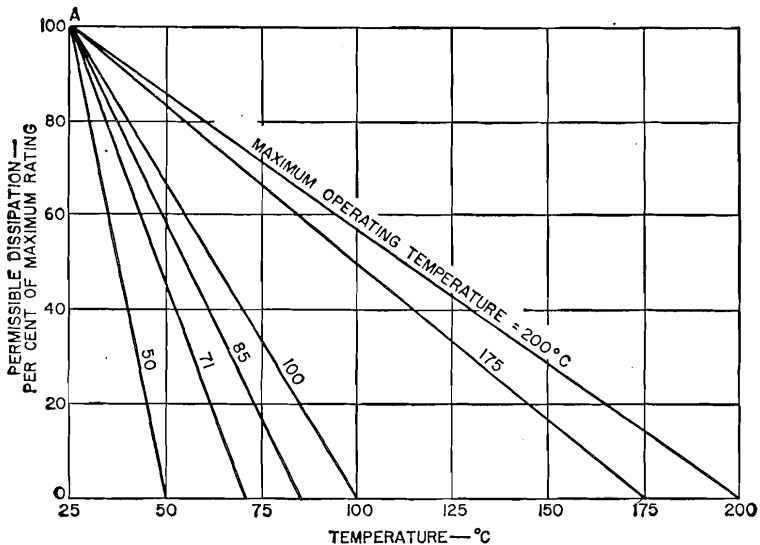

Figure 122. Chart showing maximum permissible percentage of maximum rated dissipation as a function of temperature.

data section.) The curves show the permissible percentage of the maximum dissipation ratings as a function of ambient or case temperature. Individual curves are plotted for maximum operating temperatures of 50, 71, 85, 100, 175, and 200 degrees centigrade. If the maximum operating temperature of a desired transistor type is some other value, a new curve can be drawn from point A in the figure to the desired maximum temperature value on the abscissa.

To use the chart, it is necessary to know the maximum dissipation rating and the maximum operating temperature for a given transistor. The calculation then involves only two steps:

1. A vertical line is drawn at the desired operating temperature value on the abscissa to intersect the curve representing the maximum operating temperature specified for the transistor.

2. A horizontal line drawn from this intersection point to the ordinate establishes the permissible percentage of the maximum dissipation

for the transistor at the given temperature.

The following example illustrates the calculation of the maximum permissible dissipation for transistor type 2N1490 at a case temperature of 100 degrees centigrade. This type has a maximum dissipation rating of 75 watts at a case temperature of 75 degrees centigrade, and a maximum permissible case-temperature rating of 200 degrees centigrade.

1. A perpendicular line is drawn from the 100-degree point on the abscissa to the 200-degree curve.

2. The projection of this point to the ordinate indicates a percentage of 57.5.

Therefore, the maximum permissible dissipation for the 2N1490 at a case temperature of 100 degrees centigrade is 0.575 times 75, or approximately 43 watts.

Semiconductor devices require close control of thermal variations not only during operation, but also during storage. For this reason, the maximum ratings for transistors usually include a maximum permissible storage temperature, as well as a maximum operating temperature.

Characteristics are covered in the Transistor Characteristics Section, and such data should be interpreted in accordance with the definitions given in that section. Characteristic curves represent the characteristics of an average transistor. Individual transistors, like any manufactured product, may have characteristics that range above or below the values given in the characteristic curves. Although some curves are extended beyond the maximum ratings of the transistor, this extension has been made only for convenience in calculations; no transistor should be operated outside of its maximum ratings.

Although transistor symbols have not yet been standardized for the industry, many symbols have become fairly well established by common usage. Some of the more familiar transistor symbols are listed and defined below. Unless otherwise specified, the symbols represent parameters measured under dc or static conditions.

$BV_{CBO}$  collector-to-base breakdown voltage with emitter open  
 $BV_{CEO}$  collector-to-emitter breakdown voltage with base open  
 $BV_{CER}$  collector-to-emitter breakdown voltage with specified resistance between base and emitter  
 $BV_{CERL}$  collector-to-emitter breakdown voltage with specified resistance between base and emitter and with a specified load resistance in the collector circuit.  
 $BV_{CES}$  collector-to-emitter breakdown voltage with base short-circuited to emitter  
 $BV_{CEV}$  collector-to-emitter breakdown voltage with base biased in the reverse direction with respect to emitter  
 $BV_{CEX}$  collector-to-emitter breakdown voltage with base biased in the reverse direction with respect to emitter through a specified circuit or under specified conditions  
 $BV_{EBO}$  emitter-to-base breakdown voltage with collector open

$C_{ib}$  common-base input capacitance (emitter to base)  
 $C_{ie}$  common-emitter input capacitance (base to emitter)  
 $C_{ob}$  common-base output capacitance (collector to base)  
 $C_{oe}$  common-emitter output capacitance (collector to emitter)  
 $f_{hfb}$  small-signal common-base forward-current-transfer-ratio cutoff frequency  
 $f_{hre}$  small-signal common-emitter forward-current-transfer-ratio cutoff frequency  
 $f_T$  gain-bandwidth product (measured in the common-emitter circuit)  
 $h_{FB}$  common-base forward current-transfer ratio  
 $h_{fb}$  small-signal common-base forward current-transfer ratio  
 $h_{FE}$  common-emitter forward current-transfer ratio  
 $h_{re}$  small-signal common-emitter forward current-transfer ratio  
 $h_{RB}$  common-base open-circuit reverse voltage-transfer ratio  
 $h_{RE}$  common-emitter open-circuit reverse voltage-transfer ratio  
 $I_B$  base current  
 $I_C$  collector current  
 $I_{CBO}$  collector-cutoff current with emitter open  
 $I_{CEO}$  collector-cutoff current with base open  
 $I_E$  emitter current  
 $I_{EBO}$  emitter-cutoff current with collector open  
 $P_C$  collector dissipation  
 $P_T$  total transistor dissipation  
 $Q_{SB}$  stored base charge  
 $V_{BC}$  base-to-collector voltage  
 $V_{BE}$  base-to-emitter voltage  
 $V_{CB}$  collector-to-base voltage  
 $V_{CE}$  collector-to-emitter voltage  
 $V_{EB}$  emitter-to-base voltage  
 $V_{EC}$  emitter-to-collector voltage  
 $V_{RT}$  reach-through (or punch-through) voltage

# Selection Charts

THE accompanying charts classify RCA semiconductor devices by function and by performance level. These charts are particularly useful for an initial selection of suitable transistors or rectifiers for a specific application. More complete data on

these devices, given in the Technical Data Section, should then be consulted to determine the most suitable type. For information on tunnel diodes and varactor diodes, refer to the charts on pages 324 and 328, respectively.

## TRANSISTORS

### AUDIO-FREQUENCY APPLICATIONS

#### Small Signal—Class A

2N104	2N220	2N2614
2N175	2N1010	2N3118
2N215	2N2613	

#### Driver

2N405	2N591	2N3054
2N406	2N2953	2N3055

#### Large Signal—Class A and Class B

2N109	2N649	2N2870/
2N217	2N2147	2N301A
2N270	2N2148	40022
2N407	2N2869/	40050
2N408	2N301	40051
2N647		

#### Power Amplifier

*Dissipations up to 4.9 W*

2N699	2N1492	2N1613
2N1099	2N1493	2N1711
2N1491		

*Dissipations from 5 to 49.9 W*

2N176	2N1068	2N1184
2N351	2N1183	2N1184A
2N376	2N1183A	2N1184B
2N1067	2N1183B	2N1479

2N1480	2N1701	2N2869/
2N1481	2N1768	2N301
2N1482	2N1769	2N2870/
2N1483	2N2102	2N301A
2N1484	2N2147	2N3054
2N1485	2N2148	40022
2N1486	2N2270	
2N1700	2N2339	

*Dissipations of 50 W or More*

2N173	2N1100	2N1514
2N174	2N1358	2N1702
2N277	2N1412	2N1703
2N278	2N1487	2N1905
2N441	2N1488	2N1906
2N442	2N1489	2N2015
2N443	2N1490	2N2016
2N1069	2N1511	2N2338
2N1070	2N1512	2N3055
2N1099	2N1513	

### POWER-CONVERTER APPLICATIONS

*DC-to-DC*

2N2869/2N301	2N2870/2N301A
--------------	---------------

*DC-to-AC*

2N2869/2N301	2N2870/2N301A
--------------	---------------

### RADIO-FREQUENCY APPLICATIONS

UHF Converter

2N2857
--------



VHF or HF Converter

2N140	2N1023	2N1396
2N219	2N1066	2N1397
2N274	2N1224	2N1526
2N384	2N1225	2N1527
2N411	2N1226	2N1639
2N412	2N1395	

IF Amplifier

2N139	2N1023	2N1395
2N218	2N1066	2N1396
2N274	2N1180	2N1397
2N384	2N1224	2N1524
2N409	2N1225	2N1525
2N410	2N1226	2N1638

Mixer

2N274	2N1179	2N1396
2N372	2N1224	2N1397
2N384	2N1225	2N2708
2N1023	2N1226	
2N1066	2N1395	

Oscillator

	<i>UHF</i>	
2N2857		
	<i>VHF or HF</i>	
2N274	2N1178	2N1396
2N371	2N1224	2N1397
2N384	2N1225	2N2708
2N1023	2N1226	
2N1066	2N1395	

Amplifier

	<i>UHF</i>	
2N2857		
	<i>VHF</i>	
2N384	2N1225	2N2482
2N699	2N1396	2N2631
2N914	2N1397	2N2708
2N1023	2N1491	2N2876
2N1066	2N1492	2N3118
2N1177	2N1493	
	<i>HF</i>	
2N274	2N1225	2N1493
2N370	2N1226	2N1631
2N384	2N1395	2N1632
2N708	2N1396	2N1637
2N1023	2N1397	2N2273
2N1066	2N1491	2N3118
2N1224	2N1492	

COMPUTER SWITCHING APPLICATIONS

Low-Speed Switching

(Stage Delays Greater than 300 Nanoseconds\*)

2N398	2N398B
2N398A	2N586

Medium-Speed Switching

(Stage Delays of 100 to 300 Nanoseconds\*)

2N388	2N582	2N1305
2N388A	2N585	2N1306
2N395	2N1090	2N1307
2N396	2N1091	2N1308
2N396A	2N1169 †	2N1309
2N397	2N1170 †	2N1319 †
2N404	2N1302	2N1605
2N404A	2N1303	2N1605A
2N414	2N1304	3907/2N404
2N581		

High-Speed Switching

(Stage Delays of 30 to 100 Nanoseconds\*)

2N697	2N1384	2N1854
2N1300	2N1683	2N2476
2N1301	2N1853	2N2477

Very-High-Speed Switching

(Stage Delays of 10 to 30 Nanoseconds\*)

2N705	2N834	2N965
2N706	2N914	2N966
2N706A	2N960	2N967
2N708	2N961	2N1708
2N710	2N962	2N2205
2N711	2N963	2N2206
2N828	2N964	

Ultra-High-Speed Switching

(Stage Delays of 5 to 10 Nanoseconds\*)

2N709	2N955A	2N2938
2N955	2N2475	

High-Speed Saturated Switching

2N960	2N963	2N966
2N961	2N964	2N967
2N962	2N965	2N2938

\* Measured in resistor-capacitor-transistor logic circuit. Nanoseconds = 10<sup>-9</sup> seconds.

† Bidirectional type.

## POWER SWITCHING APPLICATIONS

*Dissipations up to 4.9 W*

2N697	2N1092	2N2895
2N699	2N1613	2N2896
2N706	2N1708	2N2897
2N706A	2N1711	2N2898
2N708	2N1893	2N2899
2N718A	2N2205	2N2900
2N720A	2N2206	2N3119
2N834	2N2476	40084
2N914	2N2477	

*Dissipations from 5 W to 49.9 W*

2N1067	2N1480	2N1768
2N1068	2N1481	2N1769
2N1183	2N1482	2N2102
2N1183A	2N1483	2N2270
2N1183B	2N1484	2N2339
2N1184	2N1485	2N2405
2N1184A	2N1486	2N3053/
2N1184B	2N1700	40053
2N1479	2N1701	2N3054

*Dissipations of 50 W or More*

2N173	2N1358	2N1703
2N174	2N1412	2N1905
2N277	2N1487	2N1906
2N278	2N1488	2N2015
2N441	2N1489	2N2016
2N442	2N1490	2N2338
2N443	2N1511	2N3055
2N1069	2N1512	2N3263
2N1070	2N1513	2N3264
2N1099	2N1514	2N3265
2N1100	2N1702	2N3266

## High-Voltage Saturated Switching

2N3119

## High-Voltage, High-Frequency Pulse-Amplifier

2N3119

## VIDEO AMPLIFIER APPLICATIONS

2N274	2N1224	2N1397
2N384	2N1225	2N1491
2N699	2N1226	2N1492
2N1023	2N1395	2N1493
2N1066	2N1396	

## RECTIFIERS

TYPE	MAX. PEAK REVERSE VOLTS	MAX. AMBIENT TEMPERATURE (Operating — °C)
<i>Average Forward Current =</i>		
<i>0.125 A (Note 1)</i>		
1N3754	100	100
1N3755	200	100
1N3756	400	100
<i>Average Forward Current = 0.4 A</i>		
1N3563	1000	100
<i>Average Forward Current = 0.5 A</i>		
1N1763	400	100
1N1764	500	100
1N3196	800	100
1N3256	800	100
<i>Average Forward Current = 0.75 A</i>		
1N440B	100	165
1N441B	200	165
1N442B	300	165
1N443B	400	165
1N444B	500	150
1N445B	600	150
1N536	50	165
1N537	100	165

TYPE	MAX. PEAK REVERSE VOLTS	MAX. AMBIENT TEMPERATURE (Operating — °C)
1N538	200	165
1N539	300	165
1N540	400	165
1N547	600	165
1N1095	500	165
1N2859	100	125
1N2860	200	125
1N2861	300	125
1N2862	400	125
1N2863	500	125
1N2864	600	125
1N3193	200	100
1N3194	400	100
1N3195	600	100
1N3253	200	100
1N3254	400	100
1N3255	600	100
<i>Average Forward Current = 5 A</i>		
<i>(Note 2)</i>		
1N1612	50	175
1N1613	100	175
1N1614	200	175
1N1615	400	175
1N1616	600	175

## RECTIFIERS (cont'd)

TYPE	MAX. PEAK REVERSE VOLTS	MAX. AMBIENT TEMPERATURE (Operating—°C)	TYPE	MAX. PEAK REVERSE VOLTS	MAX. AMBIENT TEMPERATURE (Operating—°C)
<i>Average Forward Current = 10 A</i>			<i>High-Voltage, Low-Current Types</i>		
	<i>(Note 2)</i>				
40108	50	175	CR101	1200	125
40109	100	175	CR102	2000	125
40110	200	175	CR103	3000	125
40111	300	175	CR104	4000	125
40112	400	175	CR105	5000	125
40113	500	175	CR106	6000	125
40114	600	175	CR107	7000	125
40115	800	175	CR108	8000	125
40116	1000	175	CR109	9000	125
			CR110	10000	125
<i>Average Forward Current = 12 A</i>			CR201	1500	125
	<i>(Note 2)</i>		CR203	3000	125
1N1199A	50	200	CR204	4500	125
1N1200A	100	200	CR206	6000	125
1N1202A	200	200	CR208	8000	125
1N1203A	300	200	CR210	10000	125
1N1204A	400	200	CR212	12000	125
1N1205A	500	200	CR301	2400	125
1N1206A	600	200	CR302	3600	125
			CR303	4800	125
<i>Average Forward Current = 18 A</i>			CR304	6000	125
	<i>(Note 2)</i>		CR305	7200	125
40208	50	175	CR306	8400	125
40209	100	175	CR307	9600	125
40210	200	175	CR311	2400	125
40211	300	175	CR312	3600	125
40212	400	175	CR313	4800	125
40213	500	175	CR314	6000	125
40214	600	175	CR315	7200	125
			CR316	8400	125
<i>Average Forward Current = 20 A</i>			CR317	9600	125
	<i>(Note 2)</i>		CR321	2400	125
1N248C	55	175	CR322	3600	125
1N249C	110	175	CR323	4800	125
1N250C	220	175	CR324	6000	125
1N1195A	300	175	CR325	7200	125
1N1196A	400	175	CR331	2400	125
1N1197A	500	175	CR332	3600	125
1N1198A	600	175	CR333	4800	125
			CR334	6000	125
<i>Average Forward Current = 40 A</i>			CR335	7200	125
	<i>(Note 2)</i>		CR341	2400	125
1N1183A	50	200	CR342	3600	125
1N1184A	100	200	CR343	4800	125
1N1186A	200	200	CR344	6000	125
1N1187A	300	175	CR351	2400	125
1N1188A	400	175	CR352	3600	125
1N1189A	500	175	CR353	4800	125
1N1190A	600	175	CR354	6000	125

NOTE 1: With capacitive load. All other current values are for resistive or inductive load.

NOTE 2: Types in these groups are available in reverse-polarity versions. Maximum operating temperatures are case temperatures.

## SILICON CONTROLLED RECTIFIERS

TYPE	MAX. PEAK REVERSE VOLTS	MAX. AMBIENT TEMPERATURE (Operating—°C)
<i>Average Forward Current = 3.2 A</i>		
2N3228	200	100
<i>Average Forward Current = 10 A</i>		
2N1842A	25	125
2N1843A	50	125
2N1844A	100	125
2N1845A	150	125
2N1846A	200	125
2N1847A	250	125
2N1848A	300	125
2N1849A	400	125
2N1850A	500	125

TYPE	MAX. PEAK REVERSE VOLTS	MAX. AMBIENT TEMPERATURE (Operating—°C)
<i>Average Forward Current = 16 A</i>		
2N681	25	125
2N682	50	125
2N683	100	125
2N684	150	125
2N685	200	125
2N686	250	125
2N687	300	125
2N688	400	125
2N689	500	125
<i>Other</i>		
40216	600	125

## TUNNEL AND VARACTOR DIODES

See charts at end of Technical  
Data Section for complete data.

# Technical Data

This section contains technical descriptions of current RCA transistors, diodes, silicon controlled rectifiers, and other semiconductor devices. These types are listed according to the numerical-alphabetical-numerical sequence of their type designations. It also contains tabular data on RCA discontinued transistors (see page 323). In addition, this section has been expanded to include the following important semiconductor devices:

- Fin-mounted silicon rectifiers 320
- Tunnel diodes and tunnel rectifiers 324
- Varactor diodes 328

For data, see pages

For Key to Terminal Diagrams, see inside back cover.

## SILICON RECTIFIER

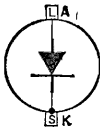

Hermetically sealed 20-ampere types used in generator-type power supplies in mobile equipment; dc-to-dc converters and battery chargers; power supplies for aircraft, marine, and missile equipment; transmitters,

**1N248A**  
**1N248B**  
**1N248C**

rf generators, and dc-motor power supplies; machine-tool controls; welding and electroplating equipment; dc-blocking service; magnetic amplifiers; and a wide variety of other heavy-duty applications. These types are designed to meet stringent environmental and mechanical specifications. The special copper-alloy mounting stud can withstand an installing torque up to 50 inch-pounds. JEDEC No. DO-5 package; outline 3, Outlines Section. Types 1N248A and 1N248B are discontinued types listed for reference only; they are similar to type 1N248C except for some slightly lower ratings, and can be directly replaced by type 1N248C. Type 1N248C is identical with type 1N1198A except for the following items:

### MAXIMUM RATINGS

*For power-supply frequency of 60 cps, single-phase operation, with resistive or inductive load*

Peak Reverse Voltage .....	55 max	volts
RMS Supply Voltage .....	39 max	volts
DC Blocking Voltage .....	50 max	volts

### CHARACTERISTICS

Maximum Reverse Current: .....		
Dynamic* .....	3.8	ma

\* Average value for one complete cycle at maximum peak reverse voltage, maximum average forward current, and case temperature = 150°C.

**SILICON RECTIFIER**

**1N248RA**  
**1N248RB**  
**1N248RC**

These types are reverse-polarity versions of types 1N248A, 1N248B, and 1N248C, respectively. Types 1N248RA and 1N248RB are discontinued types listed for reference only. JEDEC No. DO-5 package; outline 3, Outlines Section.

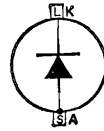

**SILICON RECTIFIER**

**1N249A**  
**1N249B**  
**1N249C**

Hermetically sealed 20-ampere types used in generator-type power supplies in mobile equipment; dc-to-dc converters, and battery chargers; power supplies for aircraft, marine, and missile equipment; transmitters,

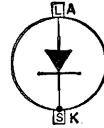

rf generators, and dc-motor supplies; machine-tool controls; welding and electroplating equipment; dc-blocking service; magnetic amplifiers; and a wide variety of other heavy-duty applications. These types are designed to meet stringent environmental and mechanical specifications. The special copper-alloy mounting stud can withstand an installing torque up to 50 inch-pounds. JEDEC No. DO-5 package; outline 3, Outlines Section. Types 1N249A and 1N249B are discontinued types listed for reference only; they are similar to type 1N249C except for some slightly lower ratings, and can be directly replaced by type 1N249C. Type 1N249C is identical with type 1N1198A except for the following items:

**MAXIMUM RATINGS**

*For power-supply frequency of 60 cps, single-phase operation, with resistive or inductive load*

Peak Reverse Voltage .....	110 max	volts
RMS Supply Voltage .....	77 max	volts
DC Blocking Voltage .....	100 max	volts

**CHARACTERISTICS**

Maximum Reverse Current:		
Dynamic* .....	3.6	ma

\* Average value for one complete cycle at maximum peak reverse voltage, maximum average forward current, and case temperature = 150°C.

**SILICON RECTIFIER**

**1N249RA**  
**1N249RB**  
**1N249RC**

These types are reverse-polarity versions of types 1N249A, 1N249B, and 1N249C, respectively. Types 1N249RA and 1N249RB are discontinued types listed for reference only. JEDEC No. DO-5 package; outline 3, Outlines Section.

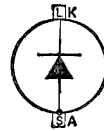

**SILICON RECTIFIER**

**1N250A**  
**1N250B**  
**1N250C**

Hermetically sealed 20-ampere supplies in mobile equipment; dc-to-dc types used in generator-type power dc converters and battery chargers; power supplies for aircraft, marine, and missile equipment; transmitters,

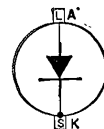

rf generators, and dc-motor power supplies; machine-tool controls; welding and

electroplating equipment; dc-blocking service; magnetic amplifiers; and a wide variety of other heavy-duty applications. These types are designed to meet stringent environmental and mechanical specifications. The special copper-alloy mounting stud can withstand an installing torque up to 50 inch-pounds. JEDEC No. DO-5 package; outline 3, Outlines Section. Types 1N250A and 1N250B are discontinued types listed for reference only; they are similar to type 1N250C except for some slightly lower ratings, and can be directly replaced by type 1N250C. Type 1N250C is identical with type 1N1198A except for the following items:

**MAXIMUM RATINGS**

*For power-supply frequency of 60 cps, single-phase operation, with resistive or inductive load*

Peak Reverse Voltage .....	220 max	volts
RMS Supply Voltage .....	154 max	volts
DC Blocking Voltage .....	200 max	volts

**CHARACTERISTICS**

Maximum Reverse Current:		
Dynamic*	3.4	ma

\* Average value for one complete cycle at maximum peak reverse voltage, maximum average forward current, and case temperature = 150°C.

**SILICON RECTIFIER**

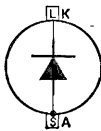

These types are reverse-polarity versions of types 1N250A, 1N250B, and 1N250C, respectively. Types 1N250RA and 1N250RB are discontinued types listed for reference only. JEDEC No. DO-5 package; outline 3, Outlines Section.

**1N250RA**  
**1N250RB**  
**1N250RC**

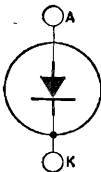

**SILICON RECTIFIER**

Hermetically sealed 750-milli-ampere type for use at peak reverse voltages up to 100 volts. It is used in magnetic amplifiers, dc-blocking circuits, power supplies, and other rectifying applications. This type is

**1N440B**

designed to meet stringent environmental and mechanical tests. JEDEC No. DO-1 package; outline 1, Outlines Section. This type is identical with type 1N443B except for the following items:

**MAXIMUM RATINGS**

*For power-supply frequency of 60 cps, single-phase operation, with resistive or inductive load*

Peak Reverse Voltage .....	100 max	volts
RMS Supply Voltage .....	70 max	volts
DC Blocking Voltage .....	100 max	volts

**CHARACTERISTICS**

Maximum Reverse Current:		
Dynamic*	100	µa
Static†	0.3	µa

\* Average value for one complete cycle at maximum peak reverse voltage, maximum average forward current, and ambient temperature = 150°C.

† DC value at maximum peak reverse voltage, average forward current = 0, and ambient temperature = 25°C.

### SILICON RECTIFIER

## 1N441B

Hermetically sealed 750-milli-ampere type for use at peak reverse voltages up to 200 volts. It is used in magnetic amplifiers, dc-blocking circuits, power supplies, and other rectifying applications. This type is

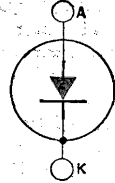

designed to meet stringent environmental and mechanical tests. JEDEC No. DO-1 package; outline 1, Outlines Section. This type is identical with type 1N443B except for the following items:

#### MAXIMUM RATINGS

*For power-supply frequency of 60 cps, single-phase operation, with resistive or inductive load*

Peak Reverse Voltage .....	200 max	volts
RMS Supply Voltage .....	140 max	volts
DC Blocking Voltage .....	200 max	volts

#### CHARACTERISTICS

##### Maximum Reverse Current:

Dynamic* .....	100	$\mu$ a
Static .....	0.75	$\mu$ a

\* Average value for one complete cycle at maximum peak reverse voltage, maximum average forward current, and ambient temperature = 150°C.

† DC value at maximum peak reverse voltage, average forward current = 0, and ambient temperature = 25°C.

### SILICON RECTIFIER

## 1N442B

Hermetically sealed 750-milli-ampere type for use at peak reverse voltages up to 300 volts. It is used in magnetic amplifiers, dc-blocking circuits, power supplies, and other rectifying applications. This type is

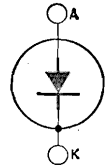

designed to meet stringent environmental and mechanical tests. JEDEC No. DO-1 package; outline 1, Outlines Section. This type is identical with type 1N443B except for the following items:

#### MAXIMUM RATINGS

*For power-supply frequency of 60 cps, single-phase operation, with resistive or inductive load*

Peak Reverse Voltage .....	300 max	volts
RMS Supply Voltage .....	210 max	volts
DC Blocking Voltage .....	300 max	volts

#### CHARACTERISTICS

##### Maximum Reverse Current:

Dynamic* .....	200	$\mu$ a
Static .....	1	$\mu$ a

\* Average value for one complete cycle at maximum peak reverse voltage, maximum average forward current, and ambient temperature = 150°C.

† DC value at maximum peak reverse voltage, average forward current = 0, and ambient temperature = 25°C.



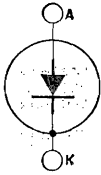

**SILICON RECTIFIER**

Hermetically sealed 750-milli-ampere type for use at peak reverse voltages up to 400 volts. It is used in magnetic amplifiers, dc-blocking circuits, power supplies, and other rectifying applications. This type is

**1N443B**

designed to meet stringent environmental and mechanical tests. JEDEC No. DO-1 package; outline 1, Outlines Section.

**MAXIMUM RATINGS**

*For power-supply frequency of 60 cps, single-phase operation, with resistive or inductive load*

Peak Reverse Voltage .....	400 max	volts
RMS Supply Voltage .....	280 max	volts
DC Blocking Voltage .....	400 max	volts
Average Forward Current:		
At ambient temperature of 50°C .....	750 max	ma
At other ambient temperatures .....	See Rating Chart	
Peak Recurrent Current .....	3.5 max	amperes
Surge Current (One Cycle) .....	15 max	amperes
Ambient-Temperature Range:		
Operating .....	-65 to 165	°C
Storage .....	-65 to 175	°C

**RATING CHART**

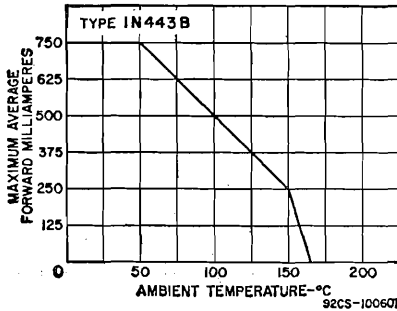

**CHARACTERISTICS**

Maximum Forward Voltage Drop* .....	1.5	volts
Maximum Reverse current:		
Dynamic† .....	200	µa
Static‡ .....	1.5	µa

\* DC value at full-load average current and ambient temperature = 25°C.

† Average value for one complete cycle at maximum peak reverse voltage, maximum average forward current, and ambient temperature = 150°C.

‡ DC value at maximum peak reverse voltage, average forward current = 0, ambient temperature = 25°C.

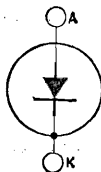

**SILICON RECTIFIER**

Hermetically sealed 750-milli-ampere type for use at peak reverse voltages up to 500 volts. It is used in magnetic amplifiers, dc-blocking circuits, power supplies, and other rectifying applications. This type is

**1N444B**

designed to meet stringent environmental and mechanical tests. JEDEC No. DO-1 package; outline 1, Outlines Section.

**MAXIMUM RATINGS**

*For power-supply frequency of 60 cps, single-phase operation, with resistive or inductive load*

Peak Reverse Voltage .....	500 max	volts
RMS Supply Voltage .....	350 max	volts
DC Blocking Voltage .....	500 max	volts
Average Forward Current:		
At ambient temperature of 35°C .....	750 max	ma
At other ambient temperatures .....	See Rating Chart	
Peak Recurrent Current .....	3.5 max	amperes
Surge Current (One Cycle) .....	15 max	amperes
Ambient-Temperature Range:		
Operating .....	-65 to 150	°C
Storage .....	-65 to 175	°C

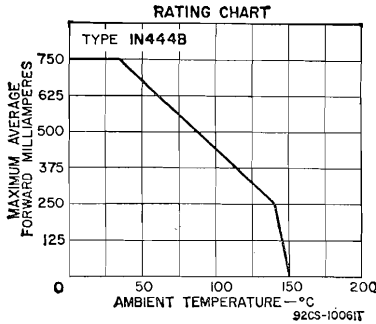

**CHARACTERISTICS**

Maximum Forward Voltage Drop* .....	1.5	volts
Maximum Reverse Current:		
Dynamic† .....	200	µa
Static .....	1.75	µa

- \* DC value at full-load average current and ambient temperature = 25°C.
- † Average value for one complete cycle at maximum peak reverse voltage, maximum average forward current, and ambient temperature = 150°C.
- ‡ DC value at maximum peak reverse voltage, average forward current = 0, and ambient temperature = 25°C.

**SILICON RECTIFIER**

Hermetically sealed 750-milliampere type for use at peak reverse voltages up to 600 volts. It is used in magnetic amplifiers, dc-blocking circuits, power supplies, and other rectifying applications. This type is

**1N445B**

designed to meet stringent environmental and mechanical tests. JEDEC No. DO-1 package; outline 1, Outlines Section.

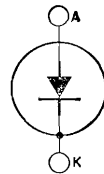

**MAXIMUM RATINGS**

*For power-supply frequency of 60 cps, single-phase operation, with resistive or inductive load*

Peak Reverse Voltage .....	600 max	volts
RMS Supply Voltage .....	420 max	volts
DC Blocking Voltage .....	600 max	volts
Average Forward Current:		
At ambient temperature of 35°C .....	750 max	ma
At other ambient temperatures .....	See Rating Chart	

Peak Recurrent Current .....	3.5 max amperes
Surge Current (One Cycle) .....	15 max amperes
Ambient-Temperature Range:	
Operating .....	-65 to 150 °C
Storage .....	-65 to 175 °C

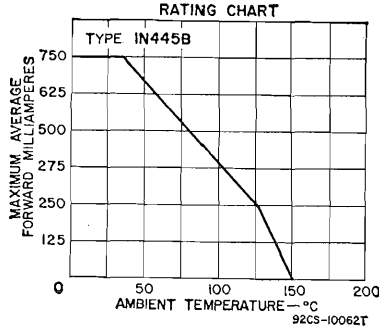

**CHARACTERISTICS**

Maximum Forward Voltage Drop* .....	1.5	volts
Maximum Reverse Current:		
Dynamic† .....	200	µa
Static† .....	2	µa

\* DC value at full-load average current and ambient temperature = 25°C.  
 † Average value for one complete cycle at maximum peak reverse voltage, maximum average forward current, and ambient temperature = 150°C.  
 † DC value at maximum peak reverse voltage, average forward current = 0, and ambient temperature = 25°C.

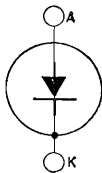

**SILICON RECTIFIER**

Hermetically sealed 750-milli-ampere type for use at peak reverse voltages up to 50 volts. It is used in magnetic amplifiers, dc-blocking circuits, power supplies, and other rectifying applications. This type is

**1N536**

designed to meet stringent environmental and mechanical tests. JEDEC No. DO-1 package; outline 1, Outlines Section. This type is identical with type 1N547 except for the following items:

**MAXIMUM RATINGS**

*For power-supply frequency of 60 cps, single-phase operation, with resistive or inductive load*

Peak Reverse Voltage .....	50 max	volts
RMS Supply Voltage .....	35 max	volts
DC Blocking Voltage .....	50 max	volts

**CHARACTERISTICS**

Maximum Forward Voltage Drop* .....	1.1	volts
Maximum Reverse Current:		
Dynamic† .....	0.4	ma

\* DC value at average forward ma = 500 and ambient temperature = 25°C.  
 † Average value for one complete cycle at maximum peak reverse voltage, maximum average forward current, and ambient temperature = 150°C.

**SILICON RECTIFIER**

**1N537**

Hermetically sealed 750-milli-ampere type for use at peak reverse voltages up to 100 volts. It is used in magnetic amplifiers, dc-blocking circuits, power supplies, and other rectifying applications. This type is designed to meet stringent environmental and mechanical tests. JEDEC No. DO-1 package; outline 1, Outlines Section. This type is identical with type 1N547 except for the following items:

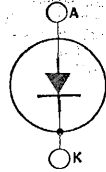

**MAXIMUM RATINGS**

*For power-supply frequency of 60 cps, single-phase operation, with resistive or inductive load*

Peak Reverse Voltage .....	100 max	volts
RMS Supply Voltage .....	70 max	volts
DC Blocking Voltage .....	100 max	volts

**CHARACTERISTICS**

Maximum Forward Voltage Drop* .....	1.1	volts
Maximum Reverse Current:		
Dynamic† .....	0.4	ma

\* DC value at average forward ma = 500 and ambient temperature = 25°C.

† Average value for one complete cycle at maximum peak reverse voltage, maximum average forward current, and ambient temperature = 150°C.

**SILICON RECTIFIER**

**1N538**

Hermetically sealed 750-milli-ampere type for use at peak reverse voltages up to 200 volts. It is used in magnetic amplifiers, dc-blocking circuits, power supplies, and other rectifying applications. This type is designed to meet stringent environmental and mechanical tests. JEDEC No. DO-1 package; outline 1, Outlines Section. This type is identical with type 1N547 except for the following items:

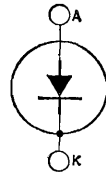

**MAXIMUM RATINGS**

*For power-supply frequency of 60 cps, single-phase operation, with resistive or inductive load*

Peak Reverse Voltage .....	200 max	volts
RMS Supply Voltage .....	140 max	volts
DC Blocking Voltage .....	200 max	volts

**CHARACTERISTICS**

Maximum Forward Voltage Drop* .....	1.1	volts
Maximum Reverse Current:		
Dynamic† .....	0.3	ma

\* DC value at average forward ma = 500 and ambient temperature = 25°C.

† Average value for one complete cycle at maximum peak reverse voltage, maximum average forward current, and ambient temperature = 150°C.

**SILICON RECTIFIER**

**1N539**

Hermetically sealed 750-milli-ampere type for use at peak reverse voltages up to 300 volts. It is used in magnetic amplifiers, dc-blocking circuits, power supplies, and other rectifying applications. This type is designed to meet stringent environmental and mechanical tests. JEDEC No.

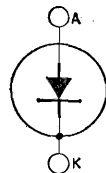

DO-1 package; outline 1, Outlines Section. This type is identical with type 1N547 except for the following items:

**MAXIMUM RATINGS**

*For power-supply frequency of 60 cps, single-phase operation, with resistive or inductive load*

Peak Reverse Voltage .....	300 max	volts
RMS Supply Voltage .....	210 max	volts
DC Blocking Voltage .....	300 max	volts

**CHARACTERISTICS**

Maximum Forward Voltage Drop* .....	1.1	volts
Maximum Reverse Current:		
Dynamic † .....	0.3	ma

\* DC value at average forward ma = 500 and ambient temperature = 25°C.

† Average value for one complete cycle at maximum peak reverse voltage, maximum average forward current, and ambient temperature = 150°C.

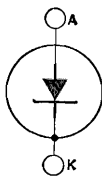

**SILICON RECTIFIER**

Hermetically sealed 750-milli-ampere type for use at peak reverse voltages up to 400 volts. It is used in magnetic amplifiers, dc-blocking circuits, power supplies, and other rectifying applications. This type is

**1N540**

designed to meet stringent environmental and mechanical tests. JEDEC No. DO-1 package; outline 1, Outlines Section. This type is identical with type 1N547 except for the following items:

**MAXIMUM RATINGS**

*For power-supply frequency of 60 cps, single-phase operation, with resistive or inductive load*

Peak Reverse Voltage .....	400 max	volts
RMS Supply Voltage .....	280 max	volts
DC Blocking Voltage .....	400 max	volts

**CHARACTERISTICS**

Maximum Forward Voltage Drop* .....	1.1	volts
Maximum Reverse Current:		
Dynamic † .....	0.3	ma

\* DC value at average forward ma = 500 and ambient temperature = 25°C.

† Average value for one complete cycle at maximum peak reverse voltage, maximum average forward current, and ambient temperature = 150°C.

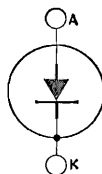

**SILICON RECTIFIER**

Hermetically sealed 750-milli-ampere type for use at peak reverse voltages up to 600 volts. It is used in magnetic amplifiers, dc-blocking circuits, power supplies, and other rectifying applications. This type is

**1N547**

designed to meet stringent environmental and mechanical tests. JEDEC No. DO-1 package; outline 1, Outlines Section.

**MAXIMUM RATINGS**

*For power-supply frequency of 60 cps, single-phase operation, with resistive or inductive load*

Peak Reverse Voltage .....	600 max	volts
RMS Supply Voltage .....	420 max	volts

DC Blocking Voltage .....	600 max	volts
Average Forward Current:		
At ambient temperature of 50°C .....	750 max	ma
At other ambient temperatures .....	See Rating Chart	15 max amperes
Surge Current (One Cycle) .....	100 max	kc
Operating Frequency .....		
Ambient-Temperature Range:		
Operating .....	-65 to 165	°C
Storage .....	-65 to 175	°C

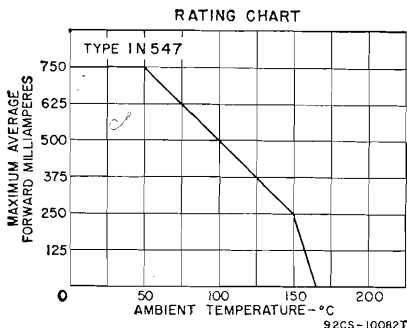

**CHARACTERISTICS**

Maximum Forward Voltage Drop* .....	1.2	volts
Maximum Reverse Current:		
Dynamic† .....	0.35	ma
Static .....	5	µa

- \* DC value at average forward ma = 500 and ambient temperature = 25°C.
- † Average value for one complete cycle at maximum peak reverse voltage, maximum average forward current, and ambient temperature = 150°C.
- ‡ DC value at maximum peak reverse voltage, average forward current = 0, and ambient temperature = 25°C.

**SILICON RECTIFIER**

**1N1095**

Hermetically sealed 750-milli-ampere type for use at peak reverse voltages up to 500 volts. It is used in magnetic amplifiers, dc-blocking circuits, power supplies, and other rectifying applications. This type is

designed to meet stringent environmental and mechanical tests. JEDEC No. DO-1 package; outline 1, Outlines Section. This type is identical with type 1N547 except for the following items:

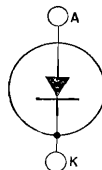

**MAXIMUM RATINGS**

*For power-supply frequency of 60 cps, single-phase operation, with resistive or inductive load*

Peak Reverse Voltage .....	500 max	volts
RMS Supply Voltage .....	350 max	volts
DC Blocking Voltage .....	500 max	volts

**CHARACTERISTICS**

Maximum Reverse Current:		
Dynamic* .....	0.3	ma

- \* Average value for one complete cycle at maximum peak reverse voltage, maximum average forward current, and ambient temperature = 150°C.

**SILICON RECTIFIER**

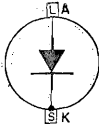

Hermetically sealed 40-ampere type for use at peak reverse voltages up to 50 volts. It is used in generator-type power supplies in mobile equipment; dc-to-dc converters and battery chargers; power supplies for

**1N1183A**

aircraft, marine and missile equipment; transmitters, rf generators, and dc-motor power supplies; machine-tool controls; welding and electroplating equipment; dc-blocking service; magnetic amplifiers; and a wide variety of other heavy-duty equipment. This type is designed to meet stringent environmental and mechanical specifications. The special copper-alloy mounting stud can withstand an installing torque up to 50 inch-pounds. JEDEC No. DO-5 package; outline 3, Outlines Section. This type is identical with type 1N1186A except for the following items:

**MAXIMUM RATINGS**

*For power-supply frequency of 60 cps, single-phase operation, with resistive or inductive load*

Peak Reverse Voltage .....	50 max	volts
RMS Supply Voltage .....	35 max	volts
DC Blocking Voltage .....	50 max	volts

**SILICON RECTIFIER**

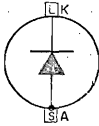

This type is a reverse-polarity version of type 1N1183A. JEDEC No. DO-5 package; outline 3, Outlines Section.

**1N1183RA**

**SILICON RECTIFIER**

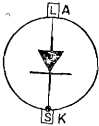

Hermetically sealed 40-ampere type for use at peak reverse voltages up to 100 volts. It is used in generator-type power supplies in mobile equipment; dc-to-dc converters and battery chargers; power supplies for

**1N1184A**

aircraft, marine, and missile equipment; transmitters, rf generators, and dc-motor power supplies; machine-tool controls; welding and electroplating equipment; dc-blocking service; magnetic amplifiers; and a wide variety of other heavy-duty equipment. This type is designed to meet stringent environmental and mechanical specifications. The special copper-alloy mounting stud can withstand an installing torque up to 50 inch-pounds. JEDEC No. DO-5 package; outline 3, Outlines Section. This type is identical with type 1N1186A except for the following items:

**MAXIMUM RATINGS**

*For power-supply frequency of 60 cps, single-phase operation, with resistive or inductive load*

Peak Reverse Voltage .....	100 max	volts
RMS Supply Voltage .....	70 max	volts
DC Blocking Voltage .....	100 max	volts

**SILICON RECTIFIER**

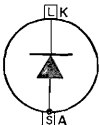

This type is a reverse-polarity version of type 1N1184A. JEDEC No. DO-5 package; outline 3, Outlines Section.

**1N1184RA**

### SILICON RECTIFIER

# 1N1186A

Hermetically sealed 40-ampere type for use at peak reverse voltages up to 200 volts. It is used in generator-type power supplies in mobile equipment; dc-to-dc converters and battery chargers; power supplies for

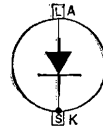

aircraft, marine, and missile equipment; transmitters, rf generators, and dc-motor power supplies; machine-tool controls; welding and electroplating equipment; dc-blocking service; magnetic amplifiers; and a wide variety of other heavy-duty applications. This type is designed to meet stringent environmental and mechanical specifications. The special copper-alloy mounting stud can withstand an installing torque up to 50 inch-pounds. JEDEC No. DO-5 package; outline 3, Outlines Section.

### MAXIMUM RATINGS

*For power-supply frequency of 60 cps, single-phase operation, with resistive or inductive load*

Peak Reverse Voltage .....	200 max	volts
RMS Supply Voltage .....	140 max	volts
DC Blocking Voltage .....	200 max	volts
Average Forward Current: At case temperature of 150°C .....	40 max	amperes
At other case temperatures .....	See Rating Chart I	
Peak Recurrent Current .....	195 max	amperes
Surge Current:* For one-half cycle, sine wave .....	800 max	amperes
For one or more cycles .....	See Rating Chart II	
Case-Temperature Range: .....	-65 to 200	°C
Operating and storage .....		

HEAT-SINK COOLING CHART

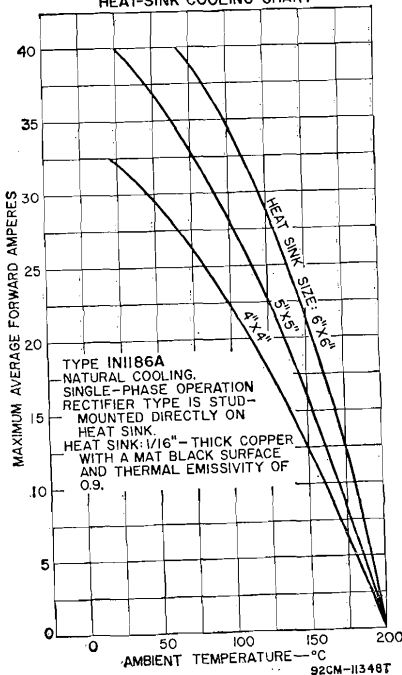

RATING CHART I

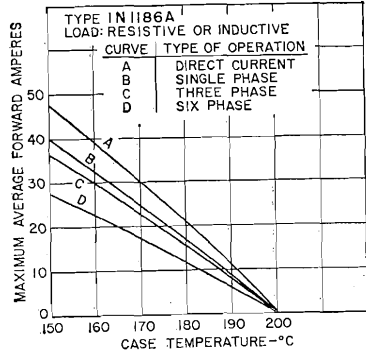

RATING CHART II

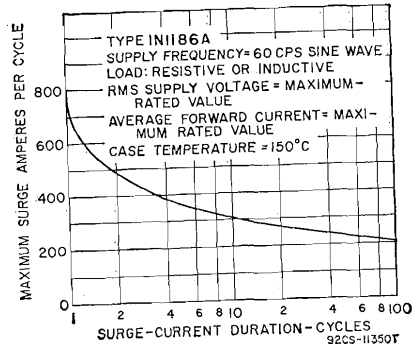



**CHARACTERISTICS**

Maximum Forward Voltage Drop†	0.65	volt
Maximum Reverse Current:		
Dynamic‡	2.5	ma
Static	0.015	ma
Maximum Thermal Resistance:		
Junction-to-case	1	°C/watt

\* Superimposed on device operating within maximum voltage, current, and temperature ratings; may be repeated after sufficient time has elapsed for the device to return to the presurge thermal-equilibrium conditions.

† Average value over one complete cycle at maximum peak reverse voltage, maximum average forward amperes, and case temperature = 150°C.

‡ DC value at maximum peak reverse voltage, average forward current = 0, and case temperature = 25°C.

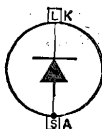

**SILICON RECTIFIER**

This type is a reverse-polarity version of type 1N1186A. JEDEC No. DO-5 package; outline 3, Outlines Section.

**1N1186RA**

**SILICON RECTIFIER**

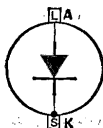

Hermetically sealed types for use at peak reverse voltages up to 300 volts. They are used in generator-type power supplies in mobile equipment; dc-to-dc converters and battery chargers; power supplies for aircraft, marine, and missile equipment; transmitters, rf generators, and dc-motor power supplies; machine-tool controls; welding and electroplating equipment; dc-blocking service; magnetic amplifiers; and a wide variety of other heavy-duty applications. These types are designed to meet stringent environmental and mechanical specifications. The special copper-alloy mounting stud can withstand an installing torque up to 50 inch-pounds. JEDEC No. DO-5 package; outline 3, Outlines Section. Type 1N1187 is a discontinued type listed for reference only. These types are identical with types 1N1190 and 1N1190A, respectively, except for the following items:

**1N1187**  
**1N1187A**

**MAXIMUM RATINGS**

*For power-supply frequency of 60 cps, single-phase operation, with resistive or inductive load*

Peak Reverse Voltage	1N1187	1N1187A	
RMS Supply Voltage	300	300 max	volts
DC Blocking Voltage	212	212 max	volts
	240	300 max	volts

**CHARACTERISTICS**

Maximum Reverse Current:		
Dynamic*	—	2.5 ma

\* Average value for one complete cycle at maximum peak reverse voltage, maximum forward amperes, and case temperature = 150°C.

**SILICON RECTIFIER**

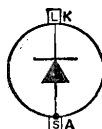

These types are reverse-polarity versions of types 1N1187 and 1N1187A. Type 1N1187R is a discontinued type listed for reference only. JEDEC No. DO-5 package; outline 3, Outlines Section.

**1N1187R**  
**1N1187RA**

### SILICON RECTIFIER

**1N1188**  
**1N1188A**

Hermetically sealed types for use at peak reverse voltages up to 400 volts. They are used in generator-type power supplies in mobile equipment; dc-to-dc converters and battery chargers; power supplies for

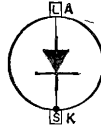

aircraft, marine, and missile equipment; transmitters, rf generators, and dc-motor power supplies; machine-tool controls; welding and electroplating equipment; dc-blocking service; magnetic amplifiers; and a wide variety of other heavy-duty applications. These types are designed to meet stringent environmental and mechanical specifications. The special copper-alloy mounting stud can withstand an installing torque up to 50 inch-pounds. JEDEC No. DO-5 package; outline 3, Outlines Section. Type 1N1188 is a discontinued type listed for reference only. These types are identical with types 1N1190 and 1N1190A, respectively, except for the following items:

#### MAXIMUM RATINGS

*For power-supply frequency of 60 cps, single-phase operation, with resistive or inductive load*

Peak Reverse Voltage .....	1N1188	1N1188A	
RMS Supply Voltage .....	400	400 max	volts
DC Blocking Voltage .....	284	284 max	volts
	320	400 max	volts

#### CHARACTERISTICS

Maximum Reverse Current:			
Dynamic*	—	2.2	ma

\* Average value for one complete cycle at maximum peak reverse voltage, maximum forward amperes, and case temperature = 150°C.

### SILICON RECTIFIER

**1N1188R**  
**1N1188RA**

These types are reverse-polarity versions of types 1N1188 and 1N1188A. Type 1N1188R is a discontinued type listed for reference only. JEDEC No. DO-5 package; outline 3, Outlines Section.

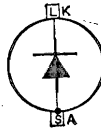

### SILICON RECTIFIER

**1N1189**  
**1N1189A**

Hermetically sealed types for use at peak reverse voltages up to 500 volts. They are used in generator-type power supplies in mobile equipment; dc-to-dc converters and battery chargers; power supplies for

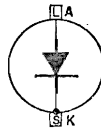

aircraft, marine, and missile equipment; transmitters, rf generators, and dc-motor power supplies; machine-tool controls; welding and electroplating equipment; dc-blocking service; magnetic amplifiers; and a wide variety of other heavy-duty applications. These types are designed to meet stringent environmental and mechanical specifications. The special copper-alloy mounting stud can withstand an installing torque up to 50 inch-pounds. JEDEC No. DO-5 package; outline 3, Outlines Section. Type 1N1189 is a discontinued type listed for reference only. These types are identical with types 1N1190 and 1N1190A, respectively, except for the following items:

**MAXIMUM RATINGS**

*For power-supply frequency of 60 cps, single-phase operation, with resistive or inductive load*

	1N1189	1N1189A	
Peak Reverse Voltage .....	500	500 max	volts
RMS Supply Voltage .....	355	355 max	volts
DC Blocking Voltage .....	400	500 max	volts

**CHARACTERISTICS**

Maximum Reverse Current:			
Dynamic*	—	2	ma

\* Average value for one complete cycle at maximum peak reverse voltage, maximum forward amperes, and case temperature = 150°C.

**SILICON RECTIFIER**

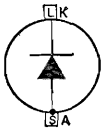

These types are reverse-polarity versions of types 1N1189 and 1N1189A. Type 1N1189R is a discontinued type listed for reference only. JEDEC No. DO-5 package; outline 3, Outlines Section.

**1N1189R**  
**1N1189RA**

**SILICON RECTIFIER**

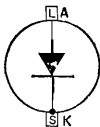

Hermetically sealed types for use at peak reverse voltages up to 600 volts. They are used in generator-type power supplies in mobile equipment; dc-to-dc converters and battery chargers; power supplies for

**1N1190**  
**1N1190A**

aircraft, marine, and missile equipment; transmitters, rf generators, and dc-motor power supplies; machine-tool controls; welding and electroplating equipment; dc-blocking service; magnetic amplifiers; and a wide variety of other heavy-duty applications. These types are designed to meet stringent environmental and mechanical specifications. The special copper-alloy mounting stud can withstand an installing torque up to 50 inch-pounds. Type 1N1190 is a discontinued type listed for reference only. JEDEC No. DO-5 package; outline 3, Outlines Section.

**MAXIMUM RATINGS**

*For power-supply frequency of 60 cps, single-phase operation, with resistive or inductive load*

	1N1190	1N1190A	
Peak Reverse Voltage .....	600	600 max	volts
RMS Supply Voltage .....	424	424 max	volts
DC Blocking Voltage .....	480	600 max	volts
Average Forward Current:			
At case temperature of 140°C .....	35	40 max	amperes
At other case temperatures .....	—	See Rating Chart I	
Peak Recurrent Current .....	130	195 max	amperes
Surge Current:*			
For one-half cycle, sine wave .....	500	800 max	amperes
For one or more cycles .....	—	See Rating Chart II	
Case-Temperature Range:			
Operating and Storage .....	-65 to 175	-65 to 200	°C

\* Superimposed on device operating within maximum voltage, current, and temperature ratings; may be repeated after sufficient time has elapsed for the device to return to presurge thermal-equilibrium conditions.

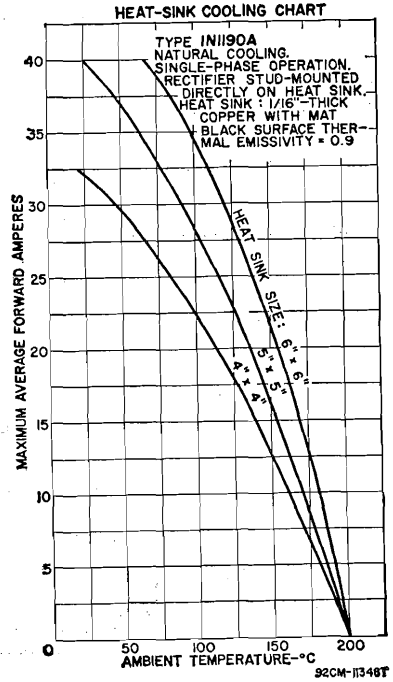
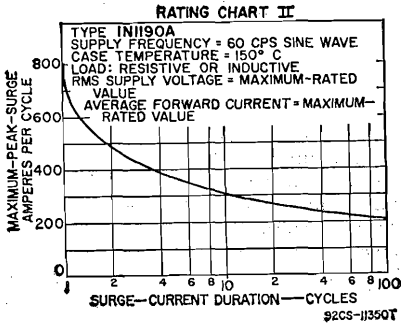
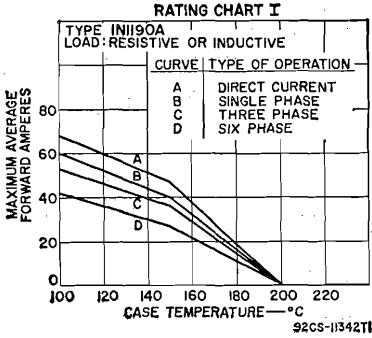

**CHARACTERISTICS**

Maximum Forward Voltage Drop**	1.7	0.65	volts
Maximum Reverse Current:			
Dynamic†	10	1.8	ma
Static	0.025	0.015	ma
Maximum Thermal Resistance:			
Junction-to-case	1	1	°C/watt

\*\* Peak value at maximum average forward current, case temperature = 140°C.

† Average value for one complete cycle at maximum peak reverse voltage, maximum average forward current, and case temperature = 140°C.

‡ DC value at maximum peak reverse voltage, average forward current = 0, and case temperature = 25°C.

**SILICON RECTIFIER**

These types are reverse-polarity versions of types 1N1190 and 1N1190A. Type 1N1190R is a discontinued type listed for reference only. JEDEC No. DO-5 package; outline 3, Outlines Section.

**1N1190R**  
**1N1190RA**

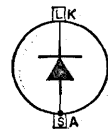

SILICON RECTIFIER

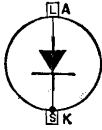

Hermetically sealed types used in generator-type power supplies in mobile equipment; dc-to-dc converters and battery chargers; power supplies for aircraft, marine, and missile equipment; transmitters, rf

1N1195  
1N1195A

generators, and dc-motor power supplies; machine-tool controls; welding and electroplating equipment; dc-blocking service; magnetic amplifiers; and a wide variety of other heavy-duty applications. These types are designed to meet stringent environmental and mechanical specifications. The special copper-alloy mounting stud can withstand an installing torque up to 50 inch-pounds. JEDEC No. DO-5 package; outline 3, Outlines Section. Type 1N1195 is a discontinued type listed for reference only; it is similar to type 1N1195A except for some slightly lower ratings, and can be directly replaced by type 1N1195A. Type 1N1195A is identical with type 1N1198A except for the following items:

MAXIMUM RATINGS

For power-supply frequency of 60 cps, single-phase operation, with resistive or inductive load

Peak Reverse Voltage .....	300 max	volts
RMS Supply Voltage .....	212 max	volts
DC Blocking Voltage .....	300 max	volts

CHARACTERISTICS

Maximum Reverse Current:		
Dynamic* .....	3.2	ma

\* Average value for one complete cycle at maximum peak reverse voltage, maximum average forward amperes, and case temperature = 150°C.

SILICON RECTIFIER

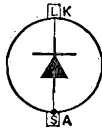

These types are reverse-polarity versions of types 1N1195 and 1N1195A, respectively. Type 1N1195R is a discontinued type listed for reference only. JEDEC No. DO-5 package; outline 3, Outlines Section.

1N1195R  
1N1195RA

SILICON RECTIFIER

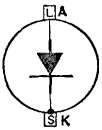

Hermetically sealed types used in generator-type power supplies in mobile equipment; dc-to-dc converters and battery chargers; power supplies for aircraft, marine, and missile equipment; transmitters, rf

1N1196  
1N1196A

generators, and dc-motor power supplies; machine-tool controls; welding and electroplating equipment; dc-blocking service; magnetic amplifiers, and a wide variety of other heavy-duty applications. These types are designed to meet stringent environmental and mechanical specifications. The special copper-alloy mounting stud can withstand an installing torque up to 50 inch-pounds. JEDEC No. DO-5 package; outline 3, Outlines Section. Type 1N1196 is a discontinued type listed for reference only; it is similar to type 1N1196A except for some slightly lower ratings, and can be directly replaced by type 1N1196A. Type 1N1196A is identical with type 1N1198A except for the following items:

MAXIMUM RATINGS

For power-supply frequency of 60 cps, single-phase operation, with resistive or inductive load

Peak Reverse Voltage .....	400 max	volts
----------------------------	---------	-------

RMS Supply Voltage .....	284 max	volts
DC Blocking Voltage .....	400 max	volts

**CHARACTERISTICS**

Maximum Reverse Current:		
Dynamic* .....	2.5	ma

\* Average value for one complete cycle at maximum peak reverse voltage, maximum average forward amperes, and case temperature = 150°C.

**SILICON RECTIFIER**

**1N1196R**  
**1N1196RA**

These types are reverse-polarity versions of types 1N1196 and 1N1196A, respectively. Type 1N1196R is a discontinued type listed for reference only. JEDEC No. DO-5 package; outline 3, Outlines Section.

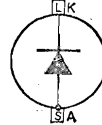

**SILICON RECTIFIER**

**1N1197**  
**1N1197A**

Hermetically sealed types for use at peak reverse voltages up to 500 volts. They are used in generator-type power supplies in mobile equipment; dc-to-dc converters and battery chargers; power supplies for

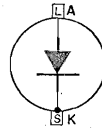

aircraft, marine, and missile equipment; transmitters, rf generators, and dc-motor supplies; machine-tool controls; welding and electroplating equipment; dc-blocking service; magnetic amplifiers, and a wide variety of other heavy-duty applications. These types are designed to meet stringent environmental and mechanical specifications. The special copper-alloy mounting stud can withstand an installing torque up to 50 inch-pounds. JEDEC No. DO-5 package; outline 3, Outlines Section. Type 1N1197 is a discontinued type listed for reference only; it is similar to type 1N1197A except for some slightly lower ratings, and can be directly replaced by type 1N1197A. Type 1N1197A is identical with type 1N1198A except for the following items:

**MAXIMUM RATINGS**

*For power-supply frequency of 60 cps, single-phase operation, with resistive or inductive load*

Peak Reverse Voltage .....	500 max	volts
RMS Supply Voltage .....	355 max	volts
DC Blocking Voltage .....	500 max	volts

**CHARACTERISTICS**

Maximum Reverse Current:		
Dynamic* .....	2.2	ma

\* Average value for one complete cycle at maximum peak reverse voltage, maximum average forward amperes, and case temperature = 150°C.

**SILICON RECTIFIER**

**1N1197R**  
**1N1197RA**

These types are reverse-polarity versions of types 1N1197 and 1N1197A, respectively. Type 1N1197R is a discontinued type listed for reference only. JEDEC No. DO-5 package; outline 3, Outlines Section.

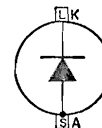

SILICON RECTIFIER

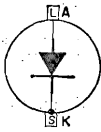

Hermetically sealed 20-ampere types for use at peak reverse voltages up to 600 volts. They are used in generator-type power supplies in mobile equipment; dc-to-dc converters and battery chargers; power

**1N1198**  
**1N1198A**

supplies for aircraft, marine, and missile equipment; transmitters, rf generators, and dc-motor power supplies; machine-tool controls; welding and electroplating equipment; dc-blocking service; magnetic amplifiers, and a wide variety of other heavy-duty applications. These types are designed to meet stringent environmental and mechanical specifications. The special copper-alloy mounting stud can withstand an installing torque up to 50 inch-pounds. JEDEC No. DO-5 package; outline 3, Outlines Section. Type 1N1198 is a discontinued type listed for reference only; it is similar to type 1N1198A except for some slightly lower ratings, and can be directly replaced by type 1N1198A.

**MAXIMUM RATINGS**

*For power-supply frequency of 60 cps, single-phase operation, with resistive or inductive load*

Peak Reverse Voltage .....	600 max	volts
RMS Supply Voltage .....	424 max	volts
DC Blocking Voltage .....	600 max	volts
Average Forward Current:		
At case temperature of 150°C .....	20 max	amperes
At other case temperatures .....	See Rating Chart I	
Peak Recurrent Current .....	90 max	amperes
Surge Current:*		
For one-half cycle, sine wave .....	350 max	amperes
For one or more cycles .....	See Rating Chart II	
Case-Temperature Range:		
Operating and storage .....	-65 to 175	°C

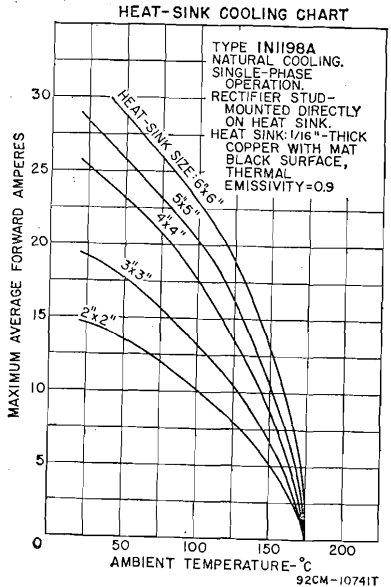
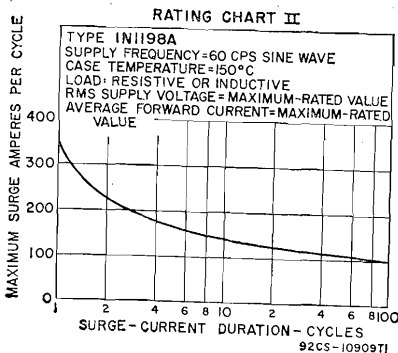
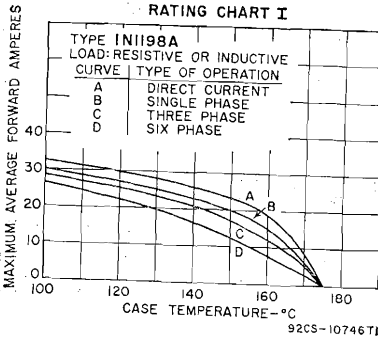

**CHARACTERISTICS**

Maximum Forward Voltage Drop† .....	0.6	volt
Maximum Reverse Current:		
Dynamic† .....	1.5	ma

\* Superimposed on device operating within maximum voltage, current, and temperature ratings; may be repeated after sufficient time has elapsed for the device to return to the presturge thermal-equilibrium conditions.

† Average value for one complete cycle at maximum peak reverse voltage, maximum average forward current, and case temperature = 150°C.

**SILICON RECTIFIER**

**1N1198R  
1N1198RA**

These types are reverse-polarity versions of types 1N1198 and 1N1198A, respectively. Type 1N1198R is a discontinued type listed for reference only. JEDEC No. DO-5 package; outline 3, Outlines Section.

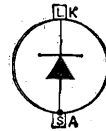

**SILICON RECTIFIER**

**1N1199A**

Hermetically sealed 12-ampere type for use at peak reverse voltages up to 50 volts. It is used in generator-type power supplies in mobile equipment; dc-to-dc converters and battery chargers; power

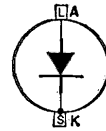

supplies for aircraft, marine, and missile equipment; transmitters, rf generators, and dc-motor power supplies; machine-tool controls; welding and electroplating equipment; dc-blocking service; magnetic amplifiers, and a wide variety of other heavy-duty applications. This type is designed to meet stringent environmental and mechanical specifications. The special copper-alloy mounting stud can withstand an installing torque up to 25 inch-pounds. JEDEC No. DO-4 package; outline 2, Outlines Section. This type is identical with type 1N1206A except for the following items:

**MAXIMUM RATINGS**

*For power-supply frequency of 60 cps, single-phase operation, with resistive or inductive load*

Peak Reverse Voltage .....	50 max	volts
Transient Reverse Voltage:		
Non-repetitive, for duration of 5 milliseconds maximum ....	100 max	volts
RMS Supply Voltage .....	35 max	volts
DC Blocking Voltage .....	50 max	volts

**CHARACTERISTICS**

Maximum Reverse Current:		
Dynamic* .....	3	ma

\* Average value for one complete cycle at maximum peak reverse voltage, maximum average forward current, and case temperature = 150°C.

**SILICON RECTIFIER**

**1N1199RA**

This type is a reverse-polarity version of type 1N1199A. JEDEC No. DO-4 package; outline 2, Outlines Section.

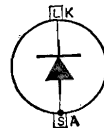



**SILICON RECTIFIER**

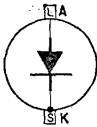

Hermetically sealed 12-ampere type for use at peak reverse voltages up to 100 volts. It is used in generator-type power supplies in mobile equipment; dc-to-dc converters and battery chargers; power

**1N1200A**

supplies for aircraft, marine, and missile equipment; transmitters, rf generators, and dc-motor power supplies; machine-tool controls; welding and electroplating equipment; dc-blocking service; magnetic amplifiers, and a wide variety of other heavy-duty applications. This type is designed to meet stringent environmental and mechanical specifications. The special copper-alloy mounting stud can withstand an installing torque up to 25 inch-pounds. JEDEC No. DO-4 package; outline 2, Outlines Section. This type is identical with type 1N1206A except for the following items:

**MAXIMUM RATINGS**

*For power-supply frequency of 60 cps, single-phase operation, with resistive or inductive load*

Peak Reverse Voltage .....	100 max	volts
Transient Reverse Voltage: Non-repetitive, for duration of 5 milliseconds maximum .....	200 max	volts
RMS Supply Voltage .....	70 max	volts
DC Blocking Voltage .....	100 max	volts

**CHARACTERISTICS**

Maximum Reverse Current: Dynamic* .....	2.5	ma
--	-----	----

\* Average value for one complete cycle at maximum peak reverse voltage, maximum average forward current, and case temperature = 150°C.

**SILICON RECTIFIER**



This type is a reverse-polarity version of type 1N1200A. JEDEC No. DO-4 package; outline 2, Outlines Section.

**1N1200RA**

**SILICON RECTIFIER**

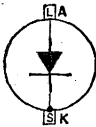

Hermetically sealed 12-ampere type for use at peak reverse voltages up to 200 volts. It is used in generator-type power supplies in mobile equipment; dc-to-dc converters and battery chargers; power

**1N1202A**

supplies for aircraft, marine, and missile equipment; transmitters, rf generators, and dc-motor power supplies; machine-tool controls; welding and electroplating equipment; dc-blocking service; magnetic amplifiers, and a wide variety of other heavy-duty applications. This type is designed to meet stringent environmental and mechanical specifications. The special copper-alloy mounting stud can withstand an installing torque up to 25 inch-pounds. JEDEC No. DO-4 package; outline 2, Outlines Section. This type is identical with type 1N1206A except for the following items:

**MAXIMUM RATINGS**

*For power-supply frequency of 60 cps, single-phase operation, with resistive or inductive load*

Peak Reverse Voltage .....	200 max	volts
----------------------------	---------	-------

**Transient Reverse Voltage:**

Non-repetitive, for duration of 5 milliseconds maximum .....	350 max	volts
RMS Supply Voltage .....	140 max	volts
DC Blocking Voltage .....	200 max	volts

**CHARACTERISTICS**

Maximum Reverse Current:		
Dynamic* .....	2	ma

\* Average value for one complete cycle at maximum peak reverse voltage, maximum average forward current, and case temperature = 150°C.

**SILICON RECTIFIER**

**1N1202RA**

This type is a reverse-polarity version of type 1N1202A. JEDEC No. DO-4 package; outline 2, Outlines Section.

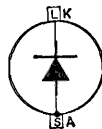

**SILICON RECTIFIER**

**1N1203A**

Hermetically sealed 12-ampere type for use at peak reverse voltages up to 300 volts. It is used in generator-type power supplies in mobile equipment; dc-to-dc converters and battery chargers; power

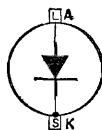

supplies for aircraft, marine, and missile equipment; transmitters, rf generators, and dc-motor power supplies; machine-tool controls; welding and electroplating equipment; dc-blocking service; magnetic amplifiers, and a wide variety of other heavy-duty applications. This type is designed to meet stringent environmental and mechanical specifications. The special copper-alloy mounting stud can withstand an installing torque up to 25 inch-pounds. JEDEC No. DO-4 package; outline 2, Outlines Section. This type is identical with type 1N1206A except for the following items:

**MAXIMUM RATINGS**

*For power-supply frequency of 60 cps, single-phase operation, with resistive or inductive load*

Peak Reverse Voltage .....	300 max	volts
Transient Reverse Voltage:		
Non-repetitive, for duration of 5 milliseconds maximum .....	450 max	volts
RMS Supply Voltage .....	212 max	volts
DC Blocking Voltage .....	300 max	volts

**CHARACTERISTICS**

Maximum Reverse Current:		
Dynamic* .....	1.75	ma

\* Average value for one complete cycle at maximum peak reverse voltage, maximum average forward current, and case temperature = 150°C.

**SILICON RECTIFIER**

**1N1203RA**

This type is a reverse-polarity version of type 1N1203A. JEDEC No. DO-4 package; outline 2, Outlines Section.

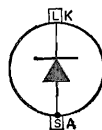

**SILICON RECTIFIER**

**1N1204A**

Hermetically sealed 12-ampere type for use at peak reverse voltages up to 400 volts. It is used in mobile equipment; dc-to-dc converters and battery chargers; power generator-type power supplies in

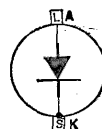

supplies for aircraft, marine, and missile equipment; transmitters, rf generators,

and dc-motor power supplies; machine-tool controls; welding and electroplating equipment; dc-blocking service; magnetic amplifiers, and a wide variety of other heavy-duty applications. This type is designed to meet stringent environmental and mechanical specifications. The special copper-alloy mounting stud can withstand an installing torque up to 25 inch-pounds. JEDEC No. DO-4 package; outline 2, Outlines Section. This type is identical with type 1N1206A except for the following items:

**MAXIMUM RATINGS**

*For power-supply frequency of 60 cps, single-phase operation, with resistive or inductive load*

Peak Reverse Voltage .....	400 max	volts
Transient Reverse Voltage: Non-repetitive, for duration of 5 milliseconds maximum ....	600 max	volts
RMS Supply Voltage .....	284 max	volts
DC Blocking Voltage .....	400 max	volts

**CHARACTERISTICS**

Maximum Reverse Current: Dynamic* .....	1.5	ma
--	-----	----

\* Average value for one complete cycle at maximum peak reverse voltage, maximum average forward current, and case temperature = 150°C.

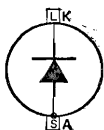

**SILICON RECTIFIER**

This type is a reverse-polarity version of type 1N1204A. JEDEC No. DO-4 package; outline 2, Outlines Section.

**1N1204RA**

**SILICON RECTIFIER**

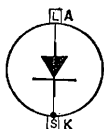

Hermetically sealed 12-ampere type for use at peak reverse voltages up to 500 volts. It is used in generator-type power supplies in mobile equipment; dc-to-dc converters and battery chargers; power

**1N1205A**

supplies for aircraft, marine, and missile equipment; transmitters, rf generators, and dc-motor power supplies; machine-tool controls; welding and electroplating equipment; dc-blocking service; magnetic amplifiers, and a wide variety of other heavy-duty applications. This type is designed to meet stringent environmental and mechanical specifications. The special copper-alloy mounting stud can withstand an installing torque up to 25 inch-pounds. JEDEC No. DO-4 package; outline 2, Outlines Section. This type is identical with type 1N1206A except for the following items:

**MAXIMUM RATINGS**

*For power-supply frequency of 60 cps, single-phase operation, with resistive or inductive load*

Peak Reverse Voltage .....	500 max	volts
Transient Reverse Voltage: Non-repetitive, for duration of 5 milliseconds maximum ....	700 max	volts
RMS Supply Voltage .....	355 max	volts
DC Blocking Voltage .....	500 max	volts

**CHARACTERISTICS**

Maximum Reverse Current: Dynamic* .....	1.25	ma
--	------	----

\* Average value for one complete cycle at maximum peak reverse voltage, maximum average forward current, and case temperature = 150°C.

**SILICON RECTIFIER**

**1N1205RA**

This type is a reverse-polarity version of type 1N1205A. JEDEC No. DO-4 package; outline 2, Outlines Section.

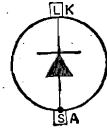

**SILICON RECTIFIER**

**1N1206A**

Hermetically sealed 12-ampere type for use at peak reverse voltages up to 600 volts. It is used in generator-type power supplies in mobile equipment; dc-to-dc converters and battery chargers; power

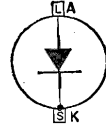

supplies for aircraft, marine, and missile equipment; transmitters, rf generators, and dc-motor power supplies; machine-tool controls; welding and electroplating equipment; dc-blocking service; magnetic amplifiers, and a wide variety of other heavy-duty applications. This type is designed to meet stringent environmental and mechanical specifications. The special copper-alloy mounting stud can withstand an installing torque up to 25 inch-pounds. JEDEC No. DO-4 package; outline 2, Outlines Section.

**HEAT-SINK COOLING CHART**

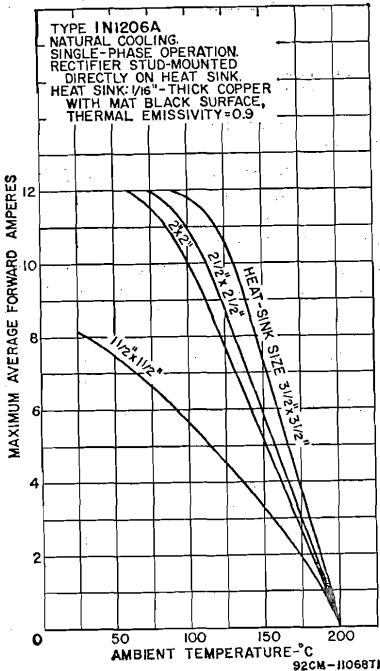

**RATING CHART I**

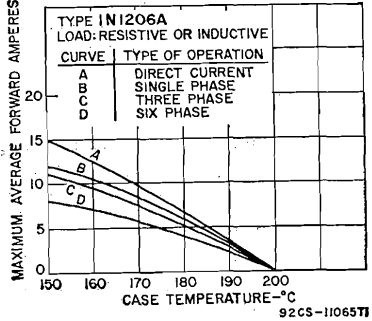

**RATING CHART II**

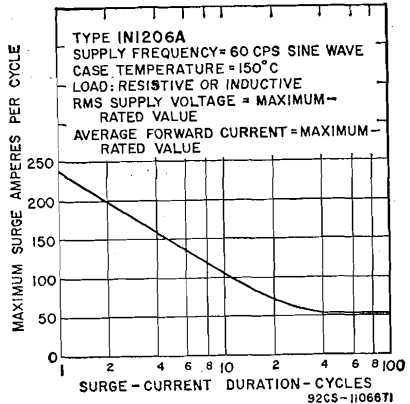

**MAXIMUM RATINGS**

*For power-supply frequency of 60 cps, single-phase operation, with resistive or inductive load*

Peak Reverse Voltage .....	600 max	volts
Transient Reverse Voltage: Non-repetitive, for duration of 5 milliseconds maximum .....	800 max	volts
RMS Supply Voltage .....	424 max	volts
DC Blocking Voltage .....	600 max	volts
Average Forward Current: At case temperature of 150°C .....	12 max	amperes
At other case temperatures .....	See Rating Chart I	
Peak Recurrent Current .....	50 max	amperes
Surge Current: ‡ For one-half cycle, sine wave .....	240 max	amperes
For one or more cycles .....	See Rating Chart II	
Case-Temperature Range: Operating and storage .....	-65 to 200	°C

‡ Superimposed on device operating within maximum voltage, current, and temperature ratings; may be repeated after sufficient time has elapsed for the device to return to the presurge thermal-equilibrium conditions.

**CHARACTERISTICS**

Maximum Forward Voltage Drop* .....	0.55	volt
Maximum Reverse Current: Dynamic* .....	1	ma
Static .....	0.004	ma
Maximum Thermal Resistance: Junction-to-case .....	2	°C/watt

\* Average value for one complete cycle at maximum peak reverse voltage, maximum average forward current, and case temperature = 150°C.

† DC value at maximum peak reverse voltage and case temperature = 25°C.

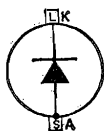

**SILICON RECTIFIER**

This type is a reverse-polarity version of type 1N1206A. JEDEC No. DO-4 package; outline 2, Outlines Section.

**1N1206RA**

**SILICON RECTIFIER**

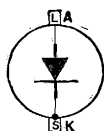

Hermetically sealed 5-ampere type for use at peak reverse voltages up to 50 volts. It is used in generator-type power supplies in mobile equipment; dc-to-dc converters and battery chargers; power

**1N1612**

supplies for aircraft, marine, and missile equipment; transmitters, rf generators, and dc-motor power supplies; machine-tool controls; welding and electroplating equipment; dc-blocking service; magnetic amplifiers, and a wide variety of other heavy-duty applications. This type is designed to meet stringent environmental and mechanical specifications. The special copper-alloy mounting stud can withstand an installing torque up to 25 inch-pounds. JEDEC No. DO-4 package; outline 2, Outlines Section. This type is identical with type 1N1616 except for the following items:

**MAXIMUM RATINGS**

*For power-supply frequency of 60 cps, single-phase operation, with resistive or inductive load*

Peak Reverse Voltage .....	50 max	volts
RMS Supply Voltage .....	35 max	volts
DC Blocking Voltage .....	50 max	volts

**SILICON RECTIFIER**

**1N1612R**

This type is a reverse-polarity version of type 1N1612. JEDEC No. DO-4 package; outline 2, Outlines Section.

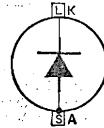

**SILICON RECTIFIER**

**1N1613**

Hermetically sealed 5-ampere type for use at peak reverse voltages up to 100 volts. It is used in generator-type power supplies in mobile equipment; dc-to-dc converters and battery chargers; power

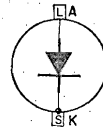

supplies for aircraft, marine, and missile equipment; transmitters, rf generators, and dc-motor power supplies; machine-tool controls; welding and electroplating equipment; dc-blocking service; magnetic amplifiers, and a wide variety of other heavy-duty applications. This type is designed to meet stringent environmental and mechanical specifications. The special copper-alloy mounting stud can withstand an installing torque up to 25 inch-pounds. JEDEC No. DO-4 package; outline 2, Outlines Section. This type is identical with type 1N1616 except for the following items:

**MAXIMUM RATINGS**

*For power-supply frequency of 60 cps, single-phase operation, with resistive or inductive load*

Peak Reverse Voltage	.....	100 max	volts
RMS Supply Voltage	.....	70 max	volts
DC Blocking Voltage	.....	100 max	volts

**SILICON RECTIFIER**

**1N1613R**

This type is a reverse-polarity version of type 1N1613. JEDEC No. DO-4 package; outline 2, Outlines Section.

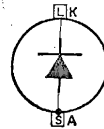

**SILICON RECTIFIER**

**1N1614**

Hermetically sealed 5-ampere type for use at peak reverse voltages up to 200 volts. It is used in generator-type power supplies in mobile equipment; dc-to-dc converters and battery chargers; power

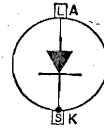

supplies for aircraft, marine, and missile equipment; transmitters, rf generators, and dc-motor power supplies; machine-tool controls; welding and electroplating equipment; dc-blocking service; magnetic amplifiers, and a wide variety of other heavy-duty applications. This type is designed to meet stringent environmental and mechanical specifications. The special copper-alloy mounting stud can withstand an installing torque up to 25 inch-pounds. JEDEC No. DO-4 package; outline 2, Outlines Section. This type is identical with type 1N1616 except for the following items:

**MAXIMUM RATINGS**

*For power-supply frequency of 60 cps, single-phase operation, with resistive or inductive load*

Peak Reverse Voltage	.....	200 max	volts
RMS Supply Voltage	.....	140 max	volts
DC Blocking Voltage	.....	200 max	volts

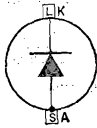

**SILICON RECTIFIER**

This type is a reverse-polarity version of type 1N1614. JEDEC No. DO-4 package; outline 2, Outlines Section.

**1N1614R**

**SILICON RECTIFIER**

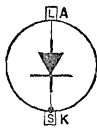

Hermetically sealed 5-ampere mobile equipment; dc-to-dc converter for use at peak reverse voltages up to 400 volts. It is used in verters and battery chargers; power generator-type power supplies in

**1N1615**

supplies for aircraft, marine, and missile equipment; transmitters, rf generators, and dc-motor power supplies; machine-tool controls; welding and electroplating equipment; dc-blocking service; magnetic amplifiers, and a wide variety of other heavy-duty applications. This type is designed to meet stringent environmental and mechanical specifications. The special copper-alloy mounting stud can withstand an installing torque up to 25 inch-pounds. JEDEC No. DO-4 package; outline 2, Outlines Section. This type is identical with type 1N1616 except for the following items:

**MAXIMUM RATINGS**

*For power-supply frequency of 60 cps, single-phase operation, with resistive or inductive load*

Peak Reverse Voltage .....	400 max	volts
RMS Supply Voltage .....	280 max	volts
DC Blocking Voltage .....	400 max	volts

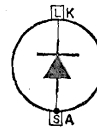

**SILICON RECTIFIER**

This type is a reverse-polarity version of type 1N1615. JEDEC No. DO-4 package; outline 2, Outlines Section.

**1N1615R**

**SILICON RECTIFIER**

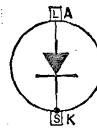

Hermetically sealed 5-ampere type for use at peak reverse voltages up to 600 volts. It is used in generator-type power supplies in mobile equipment; dc-to-dc converters and battery chargers; power

**1N1616**

supplies for aircraft, marine, and missile equipment; transmitters, rf generators, and dc-motor power supplies; machine-tool controls; welding and electroplating equipment; dc-blocking service; magnetic amplifiers, and a wide variety of other heavy-duty applications. This type is designed to meet stringent environmental and mechanical specifications. The special copper-alloy mounting stud can withstand an installing torque up to 25 inch-pounds. JEDEC No. DO-4 package; outline 2, Outlines Section.

**MAXIMUM RATINGS**

*For power-supply frequency of 60 cps, single-phase operation, with resistive or inductive load*

Peak Reverse Voltage .....	600 max	volts
RMS Supply Voltage .....	420 max	volts

DC Blocking Voltage .....	600 max	volts
Average Forward Current:		
At case temperature of 135° C .....	5 max	amperes
At other case temperatures .....	See Rating Chart	
Peak Recurrent Current .....	15 max	amperes
Case-Temperature Range:		
Operating and storage .....	-65 to 175	°C

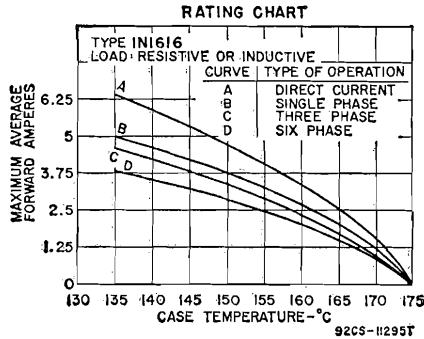

**CHARACTERISTICS**

Maximum Forward Voltage Drop* .....	1.5	volts
Maximum Reverse Current:		
Dynamic ‡ .....	1	ma
Static † .....	0.01	ma

- \* At maximum average forward current and case temperature = 25°C.
- ‡ Average value for one complete cycle at maximum peak reverse voltage, maximum average forward current, and case temperature = 135°C.
- † DC value at maximum peak reverse voltage and case temperature = 25°C.

**SILICON RECTIFIER**

**1N1616R**

This type is a reverse-polarity version of type 1N1616. JEDEC No. DO-4 package; outline 2, Outlines Section.

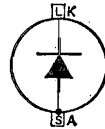

**SILICON RECTIFIER**

**1N1763**

Hermetically sealed 500-milli-ampere type for use at peak reverse voltages up to 400 volts. It is used in power supplies of color and black-and-white television receivers, radio receivers and phonographs, and in

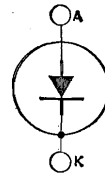

other rectifying applications. This type is intended for rectifier applications in which the device operates direct from a power line at ac voltages up to 140 volts. JEDEC No. DO-1 package; outline 1, Outlines Section. For forward-characteristic curve, refer to type 1N3196.

**MAXIMUM RATINGS**

*For power-supply frequency of 60 cps, single-phase operation, with capacitor input to filter*

Peak Reverse Voltage .....	400 max	volts
RMS Supply Voltage .....	140 max	volts
Average Forward Current:		
At ambient temperatures up to 75°C .....	500 max	ma
At ambient temperatures above 75°C .....	See Rating Chart	
Peak Recurrent Current:		
At ambient temperatures up to 75°C .....	5 max	amperes
At ambient temperatures above 75°C .....	See Rating Chart	



Surge Current (for turn-on time of 2 milliseconds duration):

At ambient temperatures up to 75°C .....	35 max amperes	
At ambient temperatures above 75°C .....	See Rating Chart	
Ambient-Temperature Range:		
Operating .....	-65 to 100	°C
Storage .....	-65 to 150	°C

**CHARACTERISTICS**

Maximum Forward Voltage Drop* .....	3	volts
Maximum Reverse Current (at maximum peak reverse voltage):		
At ambient temperature of 25°C .....	100	µa
At ambient temperature of 100°C .....	1	ma

\* Instantaneous value at average forward amperes = 15 and ambient temperature = 25°C.

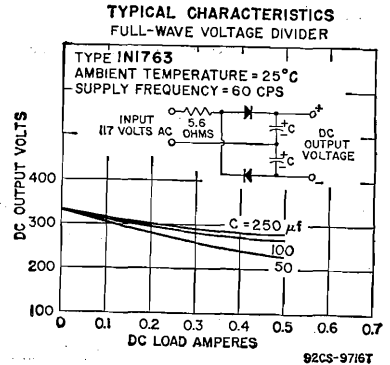
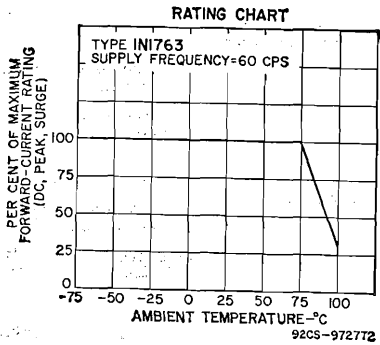

**TYPICAL OPERATION**

**As Half-Wave Rectifier**

RMS Supply Voltage .....	117	117	117	volts
Filter-Input Capacitor .....	50	100	250	µf
Surge-Limiting Resistance† .....	5.6	5.6	5.6	ohms
DC Output Voltage (Approx.) at input to filter:				
At half-load current of 250 milliamperes .....	126	146	150	volts
At full-load current of 500 milliamperes .....	100	132	139	volts
Voltage Regulation (Approx.):				
Half-load to full-load current .....	26	14	11	volts

**As Half-Wave Voltage Doubler**

RMS Supply Voltage .....	117	117	volts
Filter-Input Capacitor .....	100	250	µf
Surge-Limiting Resistance† .....	5.6	5.6	ohms
DC Output Voltage (Approx.) at input to filter:			
At half-load current of 250 milliamperes .....	273	288	volts
At full-load current of 500 milliamperes .....	235	262	volts
Voltage Regulation (Approx.):			
Half-load to full-load current .....	38	26	volts

**As Full-Wave Voltage Doubler**

RMS Supply Voltage .....	117	117	117	volts
Filter-Input Capacitor .....	50	100	250	µf
Surge-Limiting Resistance† .....	5.6	5.6	5.6	ohms
DC Output Voltage (Approx.) at input to filter:				
At half-load current of 250 milliamperes .....	260	280	290	volts
At full-load current of 500 milliamperes .....	220	260	275	volts
Voltage Regulation (Approx.):				
Half-load to full-load current .....	40	20	15	volts

† The transformer series resistance or other resistance in the line may be deducted from the value shown.

**SILICON RECTIFIER**

**1N1764**

Hermetically sealed 500-milli-ampere type for use at peak reverse voltages up to 500 volts. It is used in power supplies of color and black-and-white television receivers, radio receivers, and phonographs, and in

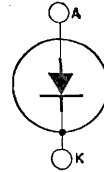

other rectifying applications. This type is intended for rectifier applications in which the device operates from the power line through a step-up transformer at ac output voltages up to 175 volts. JEDEC No. DO-1 package; outline 1, Outlines Section. For forward-characteristic curve, refer to type 1N3196.

**MAXIMUM RATINGS**

*For power-supply frequency of 60 cps, single-phase operation, with capacitor input to filter*

Peak Reverse Voltage .....	500 max	volts
RMS Supply Voltage .....	175 max	volts
Average Forward Current:		
At ambient temperatures up to 75°C .....	500 max	ma
At ambient temperatures above 75°C .....	See Rating Chart	
Peak Recurrent Current:		
At ambient temperatures up to 75°C .....	5 max	amperes
At ambient temperatures above 75°C .....	See Rating Chart	
Surge Current (for turn-on time of 2 milliseconds duration):		
At ambient temperatures up to 75°C .....	35 max	amperes
At ambient temperatures above 75°C .....	See Rating Chart	
Ambient-Temperature Range:		
Operating .....	-65 to 100	°C
Storage .....	-65 to 150	°C

**CHARACTERISTICS**

Maximum Forward Voltage Drop* .....	3	volts
Maximum Reverse Current (at maximum peak reverse voltage):		
At ambient temperature of 25°C .....	100	µA
At ambient temperature of 100°C .....	1	µA

\* Instantaneous value at average forward amperes = 15 and ambient temperature = 25°C.

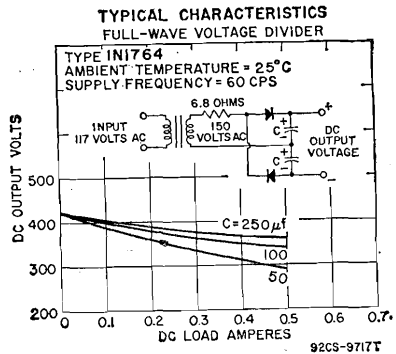
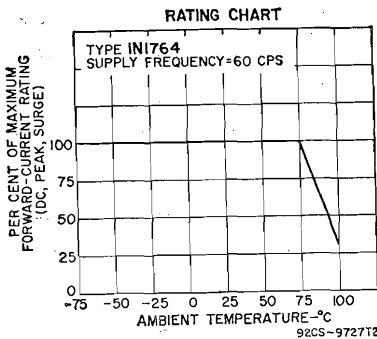

**TYPICAL OPERATION**

**As Half-Wave Rectifier**

RMS Supply Voltage .....	150	150	150	volts
Filter-Input Capacitor .....	50	100	250	µf
Surge-Limiting Resistance .....	6.8	6.8	6.8	ohms
DC Output Voltage (Approx.) at input to filter:				
At half-load current of 250 milliamperes .....	158	184	190	volts
At full-load current of 500 milliamperes .....	128	170	178	volts
Voltage Regulation (Approx.):				
Half-load to full-load current .....	30	14	12	volts

**As Half-Wave Voltage Doubler**

RMS Supply Voltage .....	150	150	volts
Filter-Input Capacitor .....	100	250	$\mu$ f
Surge-Limiting Resistance† .....	6.8	6.8	ohms
DC Output Voltage (Approx.) at input to filter:			
At half-load current of 250 milliamperes .....	345	367	volts
At full-load current of 500 milliamperes .....	301	336	volts
Voltage Regulation (Approx.):			
Half-load to full-load current .....	44	31	volts

**As Full-Wave Voltage Doubler**

RMS Supply Voltage .....	150	150	150	volts
Filter-Input Capacitor .....	50	100	250	$\mu$ f
Surge-Limiting Resistance† .....	6.8	6.8	6.8	ohms
DC Output Voltage (Approx.) at input to filter:				
At half-load current of 250 milliamperes .....	340	370	380	volts
At full-load current of 500 milliamperes .....	290	340	360	volts
Voltage Regulation (Approx.):				
Half-load to full-load current .....	50	30	20	volts

† The transformer series resistance or other resistance in the line may be deducted from the value shown.

**DIODE**

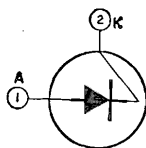

Hermetically sealed germanium type used to compensate for the effects of temperature and supply-voltage changes in class B push-pull audio-frequency power-amplifier stages. In a typical af power-amplifier circuit, it maintains the bias voltage applied to the output stage within  $\pm 0.015$  volt for supply-voltage variations up to  $-40$  per cent, and simultaneously compensates for ambient-temperature variations over the range from  $-20$  to  $71^\circ\text{C}$ . Package is similar to JEDEC No. TO-1 (outline 4, Outlines Section) except that lead No. 3 is omitted.

**1N2326**

**MAXIMUM RATINGS**

*Temperature and voltage-compensation service*

Peak Forward Current .....	200 max	ma
Reverse Voltage* .....	$-1$ max	volt
Average Forward Current .....	100 max	ma
Ambient-Temperature Range: Operating and Storage .....	$-65$ to $85$	$^\circ\text{C}$

**CHARACTERISTICS**

Forward Voltage Drop:		
At average forward ma = 2 .....	135	mv
At average forward ma = 100 .....	260	mv

\* Operation with reverse voltages is not recommended.

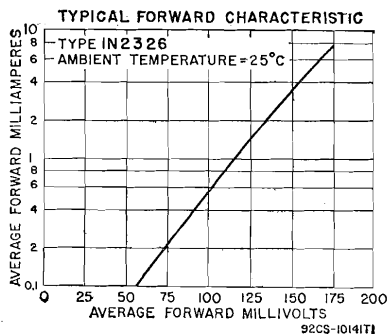
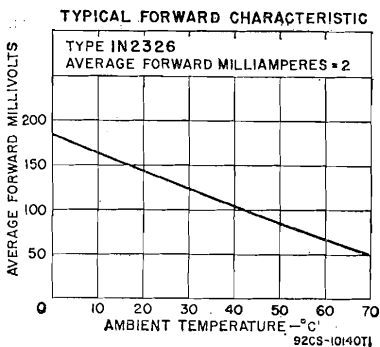

**SILICON RECTIFIER**

**1N2858**

Hermetically sealed type used in power-supply applications at peak reverse voltages up to 50 volts. This type has a maximum average-forward-current rating of 750 milli-amperes for resistive or inductive

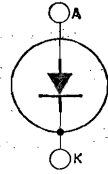

loads and 500 milliamperes for capacitive loads. JEDEC No. DO-1 package; outline 1, Outlines Section. This type is identical with type 1N2864 except for the following items:

**MAXIMUM RATINGS**

*For power-supply frequency of 60 cps, single-phase operation*

	<i>Resistive or Inductive Load</i>	<i>Capacitive Load</i>	
Peak Reverse Voltage .....	50 max	50 max	volts
RMS Supply Voltage .....	35 max	17 max	volts
DC Blocking Voltage .....	50 max	50 max	volts

**CHARACTERISTICS**

Maximum Reverse Current (at maximum peak reverse voltage) . . . . . **0.4** ma

**SILICON RECTIFIER**

**1N2859**

Hermetically sealed type used in power-supply applications at peak reverse voltages up to 100 volts. This type has a maximum average-forward-current rating of 750 milli-amperes for resistive or inductive

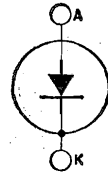

loads and 500 milliamperes for capacitive loads. JEDEC No. DO-1 package; outline 1, Outlines Section. This type is identical with type 1N2864 except for the following items:

**MAXIMUM RATINGS**

*For power-supply frequency of 60 cps, single-phase operation*

	<i>Resistive or Inductive Load</i>	<i>Capacitive Load</i>	
Peak Reverse Voltage .....	100 max	100 max	volts
RMS Supply Voltage .....	70 max	35 max	volts
DC Blocking Voltage .....	100 max	100 max	volts

**CHARACTERISTICS**

Maximum Reverse Current (at maximum peak reverse voltage) . . . . . **0.4** ma

**SILICON RECTIFIER**

**1N2860**

Hermetically sealed type used in power-supply applications at peak reverse voltages up to 200 volts. This type has a maximum average-forward-current rating of 750 milli-amperes for resistive or inductive

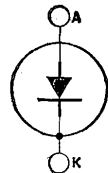

loads and 500 milliamperes for capacitive loads. JEDEC No. DO-1 package; outline 1, Outlines Section. This type is identical with type 1N2864 except for the following items:

**MAXIMUM RATINGS**

*For power-supply frequency of 60 cps, single-phase operation*

	Resistive or Inductive Load	Capacitive Load	
Peak Reverse Voltage .....	200 max	200 max	volts
RMS Supply Voltage .....	140 max	70 max	volts
DC Blocking Voltage .....	200 max	200 max	volts

**CHARACTERISTICS**

Maximum Reverse Current (at maximum peak reverse voltage) . . . . . 0.4 . . . . . ma



**SILICON RECTIFIER**

Hermetically sealed type used in power-supply applications at peak reverse voltages up to 300 volts. This type has a maximum average-forward-current rating of 750 milliamperes for resistive or inductive

**1N2861**

loads and 500 milliamperes for capacitive loads. JEDEC No. DO-1 package; outline 1, Outlines Section. This type is identical with type 1N2864 except for the following items:

**MAXIMUM RATINGS**

*For power-supply frequency of 60 cps, single-phase operation*

	Resistive or Inductive Load	Capacitive Load	
Peak Reverse Voltage .....	300 max	300 max	volts
RMS Supply Voltage .....	210 max	105 max	volts
DC Blocking Voltage .....	300 max	300 max	volts

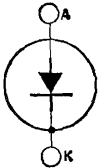

**SILICON RECTIFIER**

Hermetically sealed type used in power-supply applications at peak reverse voltages up to 400 volts. This type has a maximum average-forward-current rating of 750 milliamperes for resistive or inductive

**1N2862**

loads and 500 milliamperes for capacitive loads. JEDEC No. DO-1 package; outline 1, Outlines Section. This type is identical with type 1N2864 except for the following items:

**MAXIMUM RATINGS**

*For power-supply frequency of 60 cps, single-phase operation*

	Resistive or Inductive Load	Capacitive Load	
Peak Reverse Voltage .....	400 max	400 max	volts
RMS Supply Voltage .....	280 max	140 max	volts
DC Blocking Voltage .....	400 max	400 max	volts



**SILICON RECTIFIER**

Hermetically sealed type used in power-supply applications at peak reverse voltages up to 500 volts. This type has a maximum average-forward-current rating of 750 milliamperes for resistive or inductive

**1N2863**

loads and 500 milliamperes for capacitive loads. JEDEC No. DO-1 package;

outline 1, Outlines Section. This type is identical with type 1N2864 except for the following items:

**MAXIMUM RATINGS**

*For power-supply frequency of 60 cps, single-phase operation*

	<i>Resistive or Inductive Load</i>	<i>Capacitive Load</i>	
Peak Reverse Voltage .....	500 max	500 max	volts
RMS Supply Voltage .....	350 max	175 max	volts
DC Blocking Voltage .....	500 max	500 max	volts

**SILICON RECTIFIER**

**1N2864**

Hermetically sealed type used in power-supply applications at peak reverse voltages up to 600 volts. This type has a maximum average-forward-current rating of 750 milliamperes for resistive or inductive

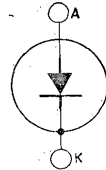

loads and 500 milliamperes for capacitive loads. JEDEC No. DO-1 package; outline 1, Outlines Section.

**MAXIMUM RATINGS**

*For power-supply frequency of 60 cps, single-phase operation*

	<i>Resistive or Inductive Load</i>	<i>Capacitive Load</i>	
Peak Reverse Voltage .....	600 max	600 max	volts
RMS Supply Voltage .....	420 max	210 max	volts
DC Blocking Voltage .....	600 max	600 max	volts
Average Forward Current:			
At ambient temperatures up to 75°C .....	750 max	500 max	ma
At ambient temperatures above 75°C .....	See Rating Chart I		
Surge Current:			
For one cycle at ambient temperature of 25°C .....	40 max	40 max	amperes
For more than one cycle and at other ambient temperatures ..	See Rating Chart II		
Operating and Storage Temperature Range: .....	-65 to 125	-65 to 125	°C

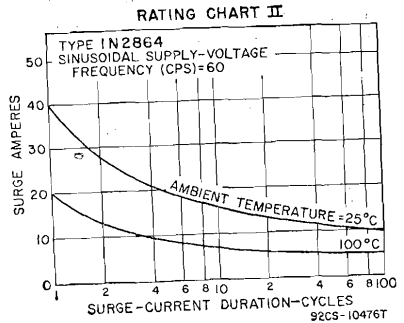
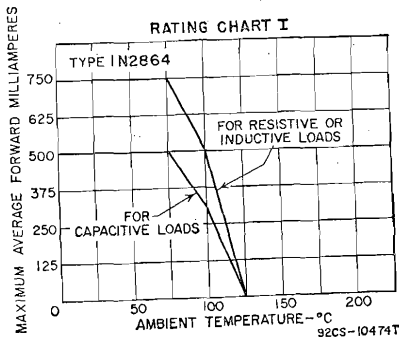

**CHARACTERISTICS**

Maximum Forward Voltage Drop* .....	1.2	volts
Maximum Reverse Current (at maximum peak reverse voltage) ..	0.3	ma

\* DC value at average forward ma = 500 and ambient temperature = 25°C.

See RCA TUNNEL DIODE CHART starting on page 324 for complete data on these types.

**1N3128**  
to  
**1N3130**

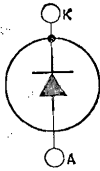

**SILICON RECTIFIER**

Hermetically sealed type used in power-supply applications at peak reverse voltages up to 200 volts. This type has a maximum average-forward-current rating of 750 milliamperes for resistive or inductive

**1N3193**

loads and 500 milliamperes for capacitive loads. It is designed to meet stringent temperature-cycling and humidity requirements of critical applications. Package is similar to JEDEC No. TO-1; outline 21, Outlines Section. This type is identical with type 1N3196 except for the following items:

**MAXIMUM RATINGS**

*For power-supply frequency of 60 cps, single-phase operation*

	Resistive or Inductive Load	Capacitive Load	
Peak Reverse Voltage .....	200 max	200 max	volts
RMS Supply Voltage .....	140 max	70 max	volts
Average Forward Current: At ambient temperatures up to 75°C .....	750 max	500 max	ma
Peak Recurrent Current .....	—	6 max	amperes

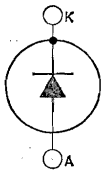

**SILICON RECTIFIER**

Hermetically sealed type used in power-supply applications at peak reverse voltages up to 400 volts. This type has a maximum average-forward-current rating of 750 milliamperes for resistive or inductive

**1N3194**

loads and 500 milliamperes for capacitive loads. It is designed to meet stringent temperature-cycling and humidity requirements of critical applications. Package is similar to JEDEC No. TO-1; outline 21, Outlines Section. This type is identical with type 1N3196 except for the following items:

**TYPICAL CHARACTERISTICS**  
HALF-WAVE VOLTAGE DIVIDER

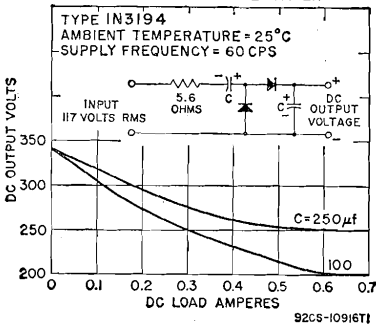

**TYPICAL CHARACTERISTICS**  
FULL-WAVE VOLTAGE DIVIDER

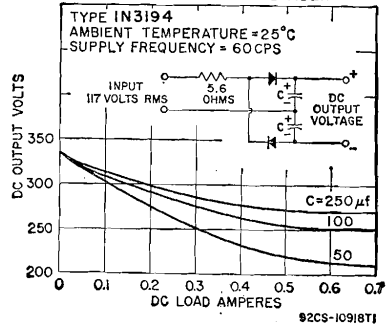

**MAXIMUM RATINGS**

*For power-supply frequency of 60 cps, single-phase operation*

	<i>Resistive or Inductive Load</i>	<i>Capacitive Load</i>	
Peak Reverse Voltage .....	400 max	400 max	volts
RMS Supply Voltage .....	280 max	140 max	volts
Average Forward Current: At ambient temperatures up to 75°C .....	750 max	500 max	ma
Peak Recurrent Current .....	—	6 max	amperes

**SILICON RECTIFIER**

**1N3195**

Hermetically sealed type used in power-supply applications at peak reverse voltages up to 600 volts. This type has a maximum average-forward-current rating of 750 milliamperes for resistive or inductive

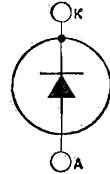

loads and 500 milliamperes for capacitive loads. It is designed to meet stringent temperature-cycling and humidity requirements of critical applications. Package is similar to JEDEC No. TO-1; outline 21, Outlines Section. This type is identical with type 1N3196 except for the following items:

**MAXIMUM RATINGS**

*For power-supply frequency of 60 cps, single-phase operation*

	<i>Resistive or Inductive Load</i>	<i>Capacitive Load</i>	
Peak Reverse Voltage .....	600 max	600 max	volts
RMS Supply Voltage .....	420 max	210 max	volts
Average Forward Current: At ambient temperatures up to 75°C .....	750 max	500 max	ma
Peak Recurrent Current .....	—	6 max	amperes

**SILICON RECTIFIER**

**1N3196**

Hermetically sealed type used in power-supply applications at peak reverse voltages up to 800 volts. This type has a maximum average-forward-current rating of 500 milliamperes for resistive or inductive

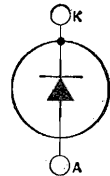

loads and 400 milliamperes for capacitive loads. It is designed to meet stringent temperature-cycling and humidity requirements of critical applications. Package is similar to JEDEC No. TO-1; outline 21, Outlines Section.

**MAXIMUM RATINGS**

*For power-supply frequency of 60 cps, single-phase operation*

	<i>Resistive or Inductive Load</i>	<i>Capacitive Load</i>	
Peak Reverse Voltage .....	800 max	800 max	volts
RMS Supply Voltage .....	560 max	280 max	volts
Average Forward Current: At ambient temperatures up to 75°C .....	500 max	400 max	ma
At other ambient temperatures .	—	See Rating Chart	
Peak Recurrent Current .....	—	5 max	amperes
Surge Current: For turn-on time of 2 milliseconds duration .....	—	35 max	amperes
Ambient-Temperature Range:			
Operating .....	-65 to 100	-65 to 100	°C
Storage .....	-65 to 175	-65 to 175	°C
Lead Temperature: For 10 seconds maximum .....	255 max	255 max	°C



**CHARACTERISTICS**

Maximum Forward Voltage Drop* .....	1.2	volts
Maximum Reverse Current:		
Dynamic .....	0.2	ma
Static .....	0.005	ma

- \* Instantaneous value at average forward amperes = 0.5 and ambient temperature = 25°C.
- † Average value for one complete cycle at maximum peak reverse voltage, maximum average forward current, and ambient temperature = 75°C.
- ‡ DC value at maximum peak reverse volts, average forward current = 0, and ambient temperature = 25°C.

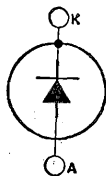
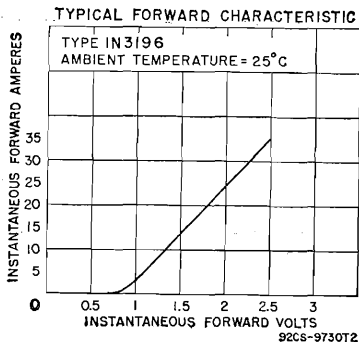
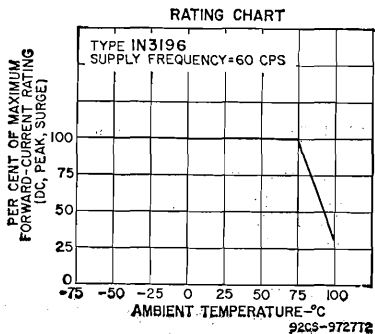

**SILICON RECTIFIER**

Hermetically sealed type used in power-supply applications at peak reverse voltages up to 200 volts. This type has a maximum average-forward-current rating of 750 milliamperes for resistive or inductive

**1N3253**

loads and 500 milliamperes for capacitive loads. It is designed to meet stringent temperature-cycling and humidity requirements of critical applications. Package is similar to JEDEC No. TO-1; outline 22, Outlines Section. This type is identical with type 1N3193 except that it has a transparent, high-dielectric-strength plastic sleeve over the metal case.

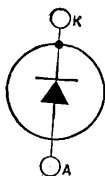

**SILICON RECTIFIER**

Hermetically sealed type used in power-supply applications at peak reverse voltages up to 400 volts. This type has a maximum average-forward-current rating of 750 milliamperes for resistive or inductive

**1N3254**

loads and 500 milliamperes for capacitive loads. It is designed to meet stringent temperature-cycling and humidity requirements of critical applications. Package is similar to JEDEC No. TO-1; outline 22, Outlines Section. This type is identical with type 1N3194 except that it has a transparent, high-dielectric-strength plastic sleeve over the metal case.

**SILICON RECTIFIER**

**1N3255**

Hermetically sealed type used in power-supply applications at peak reverse voltages up to 600 volts. This type has a maximum average-forward-current rating of 750 milliamperes for resistive or inductive

loads and 500 milliamperes for capacitive loads. It is designed to meet stringent temperature-cycling and humidity requirements of critical applications. Package is similar to JEDEC No. TO-1; outline 22, Outlines Section. This type is identical with type 1N3195 except that it has a transparent, high-dielectric-strength plastic sleeve over the metal case.

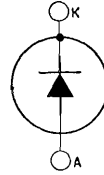

**SILICON RECTIFIER**

**1N3256**

Hermetically sealed type used in power-supply applications at peak reverse voltages up to 800 volts. This type has a maximum average-forward-current rating of 500 milliamperes for resistive or inductive

loads and 400 milliamperes for capacitive loads. It is designed to meet stringent temperature-cycling and humidity requirements of critical applications. Package is similar to JEDEC No. TO-1; outline 22, Outlines Section. This type is identical with type 1N3196 except that it has a transparent, high-dielectric-strength plastic sleeve over the metal case.

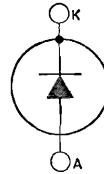

**SILICON RECTIFIER**

**1N3563**

Hermetically sealed type used in power-supply applications at peak reverse voltages up to 1000 volts. This type has a maximum average-forward-current rating of 400 milliamperes for resistive or inductive

loads and 300 milliamperes for capacitive loads. It is designed to meet stringent temperature-cycling and humidity requirements of critical applications. Package is similar to JEDEC No. TO-1; outline 22, Outlines Section. In addition, this type has a transparent, high-dielectric-strength plastic sleeve over the metal case and a protective coating to guard against the effects of severe environmental conditions. This type is electrically identical with type 1N3196 except for the following items:

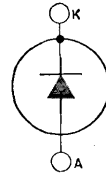

**MAXIMUM RATINGS**

*For power-supply frequency of 60 cps, single-phase operation*

	Resistive or Inductive Load	Capacitive Load	
Peak Reverse Voltage .....	1000 max	1000 max	volts
RMS Supply Voltage .....	700 max	350 max	volts
Average Forward Current:			
At ambient temperatures up to 75°C .....	400 max	300 max	ma
Peak Recurrent Current .....	—	4 max	amperes

**SILICON RECTIFIER**

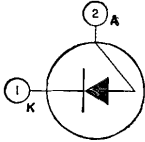

Hermetically sealed 125-milli-ampere type used in power-supply applications at peak reverse voltages up to 100 volts. This type is designed to meet stringent temperature-cycling and humidity requirements

**1N3754**

of critical applications. Package is similar to JEDEC No. TO-1 (outline 4, Outlines Section) except that lead No. 3 is omitted. It is identical with type 1N3756 except for the following items:

**MAXIMUM RATINGS**

*For power-supply frequency of 60 cps, single-phase operation, with capacitive load*

Peak Reverse Voltage .....	100 max	volts
RMS Supply Voltage .....	35 max	volts

**SILICON RECTIFIER**

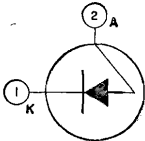

Hermetically sealed 125-milli-ampere type used in power-supply applications at peak reverse voltages up to 200 volts. This type is designed to meet stringent temperature-cycling and humidity requirements

**1N3755**

of critical applications. Package is similar to JEDEC No. TO-1 (outline 4, Outlines Section) except that lead No. 3 is omitted. It is identical with type 1N3756 except for the following items:

**MAXIMUM RATINGS**

*For power-supply frequency of 60 cps, single-phase operation, with capacitive load*

Peak Reverse Voltage .....	200 max	volts
RMS Supply Voltage .....	70 max	volts

**SILICON RECTIFIER**

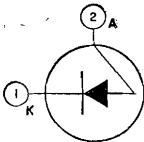

Hermetically sealed 125-milli-ampere type used in power-supply applications at peak reverse voltages up to 400 volts. This type is designed to meet stringent temperature-cycling and humidity requirements

**1N3756**

of critical applications. Package is similar to JEDEC No. TO-1 (outline 4, Outlines Section) except that lead No. 3 is omitted.

**MAXIMUM RATINGS**

*For power-supply frequency of 60 cps, single-phase operation, with capacitive load*

Peak Reverse Voltage .....	400 max	volts
RMS Supply Voltage .....	140 max	volts
Average Forward Current:		
At ambient temperatures up to 65°C .....	125 max	ma
At ambient temperatures above 65°C .....	See Rating Chart	
Peak Recurrent Current .....	1.3 max	amperes
Surge Current:		
For turn-on time of 2 milliseconds duration .....	30 max	amperes
Ambient-Temperature Range:		
Operating .....	-65 to 100	°C
Storage .....	-65 to 175	°C
Lead Temperature:		
For 10 seconds maximum .....	255 max	°C

**CHARACTERISTICS**

Maximum Forward Voltage Drop* .....	1	volt
-------------------------------------	---	------

Maximum Reverse Current:

Dynamic†	.....	0.3	ma
Static‡	.....	0.005	ma

- \* Instantaneous value at maximum average forward current and ambient temperature = 25°C.
- † Average value for one complete cycle at maximum peak reverse voltage, maximum average forward current, and ambient temperature = 65°C.
- ‡ DC value at maximum peak reverse voltage, average forward current = 0, and ambient temperature = 25°C.

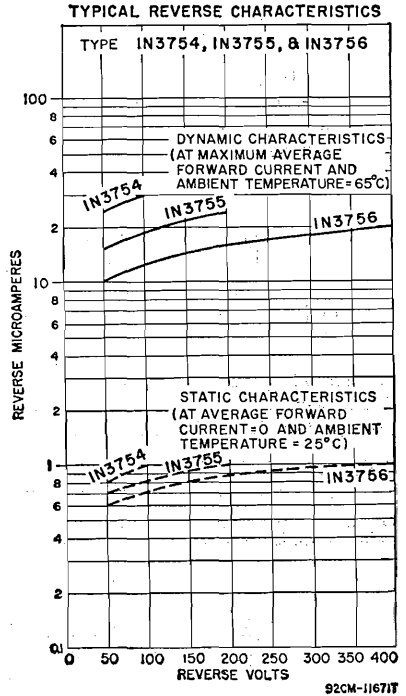
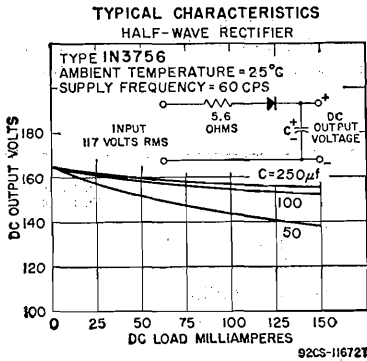
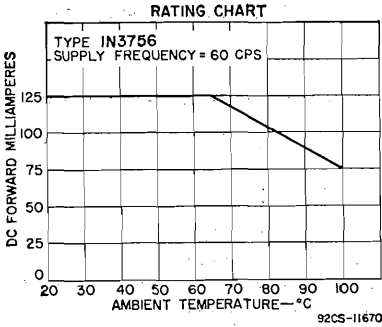

**IN3847**  
to  
**IN3863**

See RCA TUNNEL DIODE CHART for complete data on these tunnel diodes and rectifiers.

**TWIN DIODE**

Hermetically sealed germanium type used in high-speed switching service in electronic data-processing systems. Maximum ratings: dc reverse voltage = -20 volts; average forward current = -40 milliamperes;

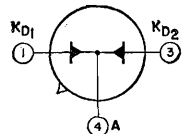

**2DG001**

ambient temperature range = -65 to 85°C. Package is similar to JEDEC No. TO-33 (outline 13, Outlines Section) except that lead No. 2 is omitted. This is a discontinued type listed for reference only.

**TRANSISTOR**

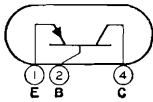

Germanium p-n-p type used in low-power audio-frequency amplifier applications. In a common-emitter circuit, this type has a forward-current transfer ratio of 44, a low-frequency power gain of 41

**2N104**

db, and an integrated noise factor of 12 db maximum. JEDEC No. TO-40 package; outline 15, Outlines Section.

**MAXIMUM RATINGS**

Collector-to-Base Voltage (with emitter open) .....	-30 max	volts
Collector Current .....	-50 max	ma
Emitter Current .....	50 max	ma
Transistor Dissipation:		
At ambient temperatures up to 25°C .....	150 max	mw
At ambient temperature of 50°C .....	80 max	mw
At ambient temperature of 70°C .....	30 max	mw
Ambient-Temperature Range:		
Operating .....	-65 to 70	°C
Storage .....	-65 to 85	°C

**CHARACTERISTICS**

Collector-to-Base Breakdown Voltage (with collector $\mu$ a = -20 and emitter current = 0) .....	-30 min	volts
Collector-Cutoff Current (with collector-to-base volts = -12 and emitter current = 0) .....	-10 max	$\mu$ a
Emitter-Cutoff Current (with emitter-to-base volts = -12 and collector current = 0) .....	-10 max	$\mu$ a
Thermal Resistance:		
Junction-to-ambient .....	0.4	°C/mw

*In Common-Base Circuit*

Small-Signal Forward-Current-Transfer-

Ratio Cutoff Frequency:		
With collector-to-base volts = -6 and collector ma = -1 ..	700	kc
With collector-to-base volts = -3 and collector ma = -0.2 ..	530	kc
Power Gain (with collector-to-emitter volts = -6, collector ma = -1, input resistance = 170 ohms, and load resistance = 0.5 megohm) .....	32.4	db

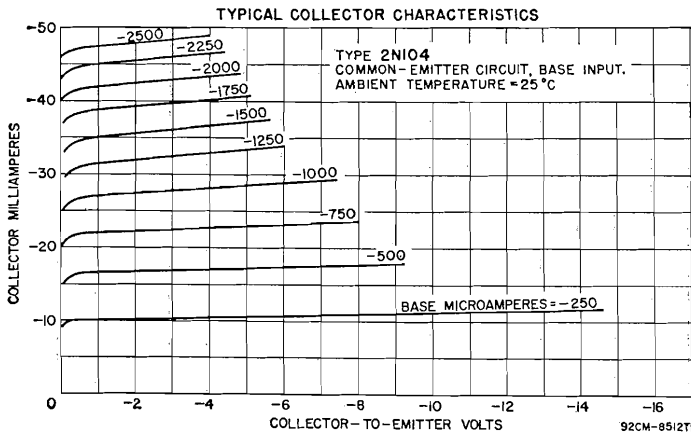

*In Common-Emitter Circuit*

Small-Signal Forward-Current-Transfer-

Ratio Cutoff Frequency:		
With collector-to-emitter volts = -6 and collector ma = -1 ..	13.9	kc
With collector-to-emitter volts = -3 and collector ma = -0.2 ..	16.5	kc

Power Gain (with collector-to-emitter volts = -6, collector ma = -1, input resistance = 1400 ohms, and load resistance = 20000 ohms)	41	db
Noise Figure (with collector-to-emitter volts = -4, collector ma = -0.7, and generator resistance = 518 ohms)	12 max	db

**In Common-Collector Circuit**

Power Gain (with emitter-to-collector volts = -3, collector ma = -0.2, input resistance = 0.5 megohm, and load resistance = 18000 ohms)	14.3	db
---	------	----

TYPICAL COLLECTOR CHARACTERISTICS

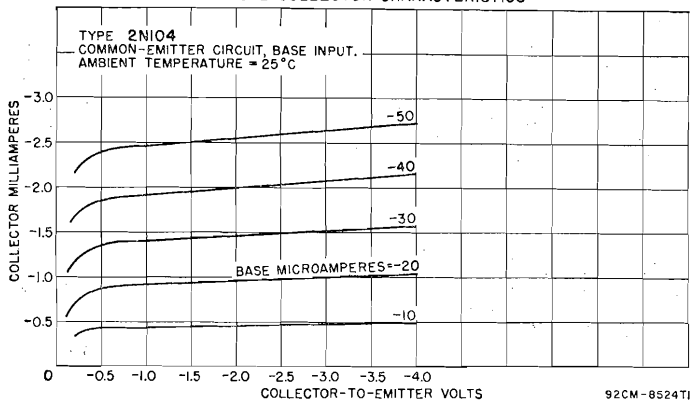

**2N105**

See list of Discontinued Transistors at end of Technical Data Section for abbreviated data.

**TRANSISTOR**

**2N109**

Germanium p-n-p type used in large-signal audio-frequency amplifier applications. It is used in class B push-pull power-output stages of battery-operated portable radio receivers and audio amplifiers

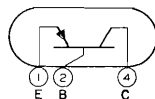

and in class A high-gain driver stages. JEDEC No. TO-40 package; outline 15, Outlines Section.

**MAXIMUM RATINGS**

Collector-to-Base Voltage (with emitter open)	-35 max	volts
Collector-to-Emitter Voltage	-25 max	volts
Emitter-to-Base Voltage (with collector open)	-12 max	volts
Collector Current	-150 max	ma
Emitter Current	70 max	ma
Transistor Dissipation:		
At ambient temperatures up to 25°C	165 max	mw
At ambient temperatures above 25°C	See curve	page 80
Temperature Range:		
Operating	-65 to 71	°C
Storage	-65 to 85	°C
Lead Temperature (for 10 seconds maximum)	255 max	°C

**CHARACTERISTICS**

Collector-Cutoff Current (with collector-to-base volts = -30 and emitter current = 0)	-7 max	µa
Emitter-Cutoff Current (with emitter-to-base volts = -12 and collector current = 0)	-7 max	µa
Base-to-Emitter Voltage (with collector-to-emitter volt = -1 and collector ma = -50 ma)	0.2 to 0.4	volt

Collector-to-Emitter Saturation Voltage (with collector ma = -50 and base current = -5 ma)	-0.15 max	volt
Collector-to-Base Breakdown Voltage (with collector $\mu$ a = -50 and emitter current = 0)	-35 min	volts
Emitter-to-Base Breakdown Voltage (with emitter $\mu$ a = -7 and collector current = 0)	-12 min	volts
Collector-to-Emitter Breakdown Voltage (with collector ma = -1 and base current = 0)	-25 min	volts

**In Common-Base Circuit**

Collector-to-Base Capacitance (with collector-to-base volts = -6 and emitter current = 0)	20 to 60	pf
---	----------	----

**In Common-Emitter Circuit**

DC Forward Current-Transfer Ratio (with collector-to-emitter volts = -6, collector ma = -1, and frequency = 1 kilocycle)	50 to 150	
Input Resistance at 1 kilocycle	1000 to 4000	ohms

**TYPICAL OPERATION IN CLASS B PUSH-PULL AF AMPLIFIER CIRCUIT**

*Values are for two transistors except as noted*

DC Collector-to-Emitter Supply Voltage	-4.5	-9	volts
DC Base-to-Emitter Voltage	-0.15	-0.15	volt
Peak Collector Current (approx.) per transistor	-35	-40	ma
Maximum-Signal DC Collector Current (approx.) per transistor	-11.5	-13	ma
Zero-Signal DC Collector Current (approx.) per transistor	-2	-2	ma
Signal-Source Impedance per base	375	375	ohms
Load Impedance per collector	100	200	ohms
Signal Frequency	1	1	kc
Circuit Efficiency at maximum rated output	60	69	per cent
Power Gain	30	33	db
Total Harmonic Distortion	10 max	10 max	per cent
Maximum-Signal Power Output	75	160	mw

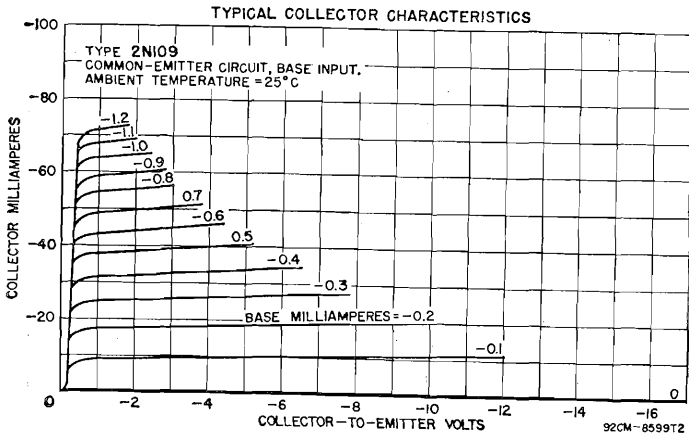
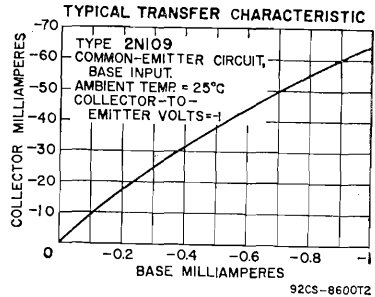
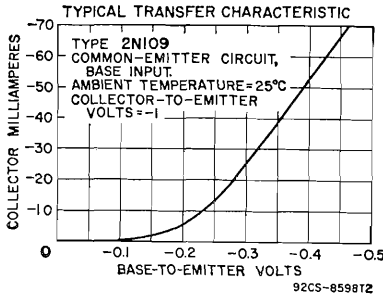

**TRANSISTOR**

**2N139**

Germanium p-n-p type used primarily in 455-kilocycle intermediate-frequency amplifier applications in battery-operated portable radio receivers and automobile radio receivers operating from either a

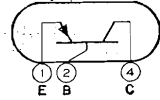

6-volt or a 12-volt supply. JEDEC No. TO-40 package; outline 15, Outlines Section.

**MAXIMUM RATINGS**

Collector-to-Base Voltage (with emitter open) .....	-16 max	volts
Emitter-to-Base Voltage (with collector open) .....	-12 max	volts
Collector Current .....	-15 max	ma
Emitter Current .....	15 max	ma
Transistor Dissipation .....	35 max	mw
Ambient-Temperature Range:		
Operating .....	-65 to 70	°C
Storage .....	-65 to 85	°C

**CHARACTERISTICS**

Collector-to-Base Breakdown Voltage (with collector $\mu$ a = -10 and emitter current = 0) .....	-16 min	volts
Collector-Cutoff Current (with collector-to-base volts = -12 and emitter current = 0) .....	-6 max	$\mu$ a
Emitter-Cutoff Current (with emitter-to-base volts = -12 and collector current = 0) .....	-40 max	$\mu$ a

**In Common-Base Circuit**

Small-Signal Forward Current-Transfer Ratio:		
With collector-to-base volts = -9 and collector ma = -0.5 ..	0.978	
With collector-to-base volts = -9 and collector ma = -1 ..	0.98	
Small-Signal Forward-Current-Transfer-Ratio Cutoff Frequency:		
With collector-to-base volts = -9 and collector ma = -0.5 ..	4.5	Mc
With collector-to-base volts = -9 and collector ma = -1 ..	4.7	Mc

**In Common-Emitter Circuit**

Small-Signal Forward Current-Transfer Ratio:	
With collector-to-emitter volts = -9 and collector ma = -0.5 ..	45
With collector-to-emitter volts = -9 and collector ma = -1 ..	48

**TYPICAL OPERATION IN 455-KC IF AMPLIFIER CIRCUIT**

DC Collector-to-Emitter Voltage .....	-9	-9	volts
DC Collector Current .....	-0.5	-1	ma
Input Resistance (approx.) .....	1000	500	ohms
Output Resistance (approx.) .....	70000	30000	ohms
Maximum Power Gain (approx.) .....	38	37	db
Useful Power Gain (approx.) .....	27.6	30.4	db
Spot Noise Figure (approx.) .....	4.5	4.5	db

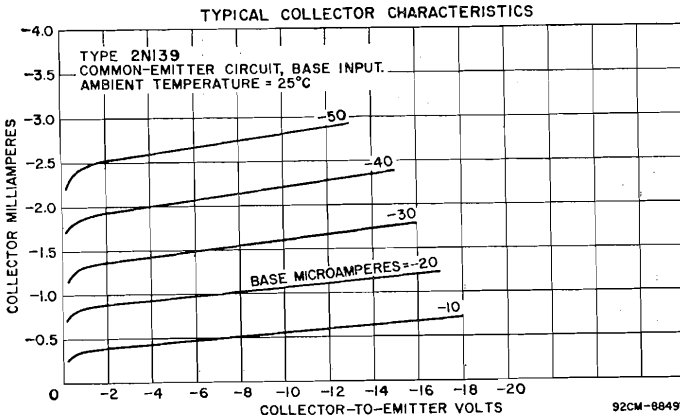



TRANSISTOR

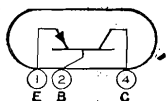

2N140

Germanium p-n-p type used primarily in converter and mixer-oscillator applications in AM battery-operated portable radio receivers and automobile radio receivers operating from either a 6-volt or a 12-volt supply. JEDEC No. TO-40 package; outline 15, Outlines Section. For curves of typical collector characteristics, refer to type 2N139.

MAXIMUM RATINGS

Collector-to-Base Voltage (with emitter open) .....	-16 max	volt
Emitter-to-Base Voltage (with collector open) .....	-0.5 max	volt
Collector Current .....	-15 max	ma
Emitter Current .....	15 max	ma
Transistor Dissipation .....	80 max	mw
Ambient-Temperature Range:		
Operating .....	-65 to 71	°C
Storage .....	-65 to 85	°C

CHARACTERISTICS

Collector-to-Base Breakdown Voltage (with collector $\mu\text{a} = -10$ and emitter current = 0) .....	-16 min	volt
Collector-Cutoff Current (with collector-to-base volts = -12 and emitter current = 0) .....	-6 max	$\mu\text{a}$
Emitter-Cutoff Current (with emitter-to-base volts = -0.5 and collector current = 0) .....	-12 max	$\mu\text{a}$

In Common-Emitter Circuit

Small-Signal Forward Current-Transfer Ratio (with collector-to-emitter volts = -9 and collector ma = -0.6)	75
---	----

TYPICAL OPERATION AT 1 MC IN SELF-EXCITED CONVERTER CIRCUIT

DC Collector-to-Emitter Voltage .....	-9	volt
DC Collector Current .....	-0.6	ma
RMS Base-to-Emitter Oscillator Injection Voltage (approx.) ...	100	mv
Input Resistance (approx.) .....	700	ohms
Output Resistance (approx.) .....	75000	ohms
Useful Conversion Power Gain (approx.) .....	32	db

POWER TRANSISTOR

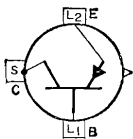

2N173

Germanium p-n-p type used in a wide variety of switching and amplifier applications in industrial and military equipment requiring transistors having high voltage, current, and dissipation values. It is used in power-switching, voltage- and current-regulating, dc-to-dc converter, inverter, power-supply, and relay- and solenoid-actuating circuits; and in low-frequency oscillator and audio-amplifier service. This type is designed to provide satisfactory performance under extreme environmental conditions of temperature, moisture, and altitude; it is stud-mounted to provide positive heat-sink contact, and has a cold-weld seal to insure reliable performance under severe environmental conditions. JEDEC No. TO-36 package; outline 14, Outlines Section.

MAXIMUM RATINGS

Collector-to-Base Voltage (with emitter-to-base volts = -1.5) ..	-60 max	volt
Emitter-to-Base Voltage (with collector open) .....	-40 max	volt
Collector Current .....	-15 max	amperes
Emitter Current .....	15 max	amperes
Base Current .....	-4 max	amperes
Transistor Dissipation:		
At case temperatures up to 25°C .....	150 max	watts
At case temperatures above 25°C .....	See curve page 80	
Case-Temperature Range:		
Operating and storage .....	-65 to 100	°C

**CHARACTERISTICS**

**Collector-to-Emitter Breakdown Voltage:**

With base short-circuited to emitter and collector amperes = 0.3	-50 min	volts
With base open and collector amperes = 0.3	-50	volts
With base open and collector amperes = -1	-45 min	volts
Base-to-Emitter Voltage (with collector-to-emitter volts = -2 and collector amperes = -5)	-0.65	volt
Emitter-to-Base Voltage (with collector-to-base volts = -80 and emitter current = 0)	-0.15	volt
Collector-to-Emitter Saturation Voltage (with collector amperes = -12 and base amperes = -2)	-0.3	volt
Collector-to-Emitter Reach-Through Voltage	-60 min	volts
Emitter-Cutoff Current (with emitter-to-base volts = -40 and collector current = 0)	-1	ma
Collector-Cutoff Current:		
With collector-to-base volts = -2 and emitter current = 0	-100	$\mu$ A
With collector-to-base volts = -60 and emitter current = 0	-2	ma
Thermal Resistance (junction-to-case)	0.35	$^{\circ}$ C/watt
Thermal Capacity (for pulses in the 1-to-10-millisecond range)	0.075	watt-sec/ $^{\circ}$ C
Thermal Time Constant	26.25	msec

**In Common-Emitter Circuit**

DC Forward Current-Transfer Ratio (with collector-to-emitter volts = -2):

With collector amperes = -5	35 to 70	
With collector amperes = -12	25	
Small-Signal Forward-Current-Transfer-Ratio Cutoff Frequency (with collector-to-emitter volts = -6 and collector amperes = -5)	10	kc

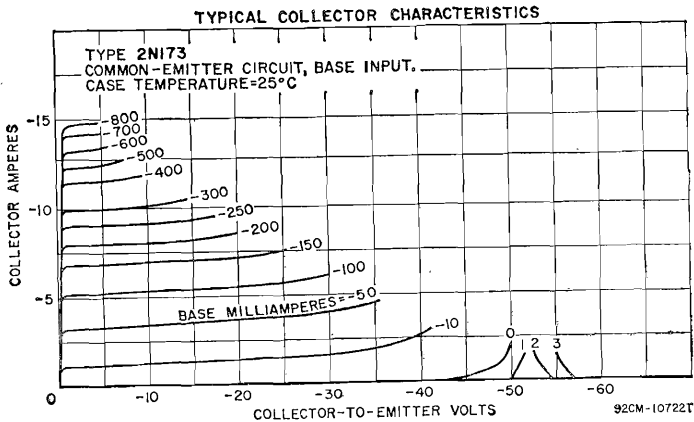
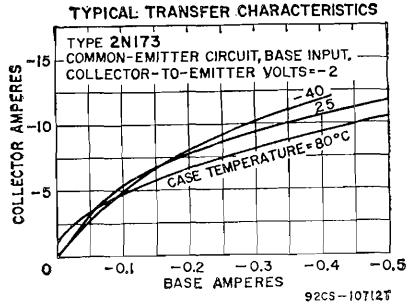
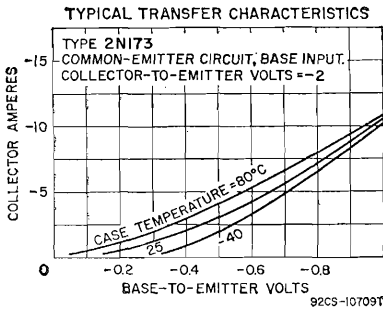

**TYPICAL OPERATION IN POWER-SWITCHING CIRCUIT**

DC Collector Supply Voltage .....	-12	volts
DC Base Supply Voltage .....	6	volts
On DC Collector Current .....	-12	amperes
Turn-On DC Base Current .....	-2	amperes
Turn-Off DC Base Current .....	0	amperes
Switching Time:		
Rise time .....	15	$\mu$ sec
Fall time .....	15	$\mu$ sec

**POWER TRANSISTOR**

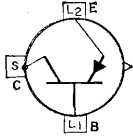

Germanium p-n-p type used in a wide variety of switching and amplifier applications in industrial and military equipment requiring transistors having high voltage, current, and dissipation values. It is used in

**2N174**

power-switching, voltage- and current-regulating, dc-to-dc converter, inverter, power-supply, and relay- and solenoid-actuating circuits; and in low-frequency oscillator and audio-amplifier service. This type is designed to provide satisfactory performance under extreme environmental conditions of temperature, moisture, and altitude; it is stud-mounted to provide positive heat-sink contact, and has a cold-weld seal to insure reliable performance under severe environmental conditions. JEDEC No. TO-36 package; outline 14, Outlines Section.

**MAXIMUM RATINGS**

Collector-to-Base Voltage (with emitter-to-base volts = -1.5) ..	-80 max	volts
Emitter-to-Base Voltage (with collector open) .....	-60 max	volts
Collector Current .....	-15 max	amperes
Emitter Current .....	15 max	amperes
Base Current .....	-4 max	amperes
Transistor Dissipation:		
At case temperatures up to 25°C .....	150 max	watts
At case temperatures above 25°C .....	See curve	page 80
Case-Temperature Range:		
Operating and storage .....	-65 to 100	°C

**TYPICAL TRANSFER CHARACTERISTICS**

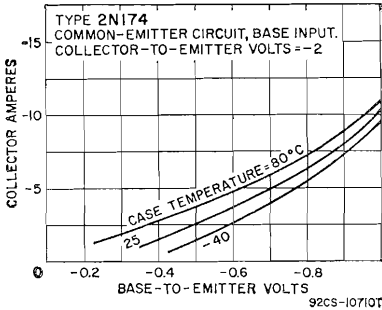

**TYPICAL TRANSFER CHARACTERISTICS**

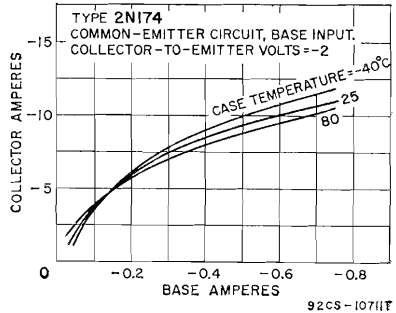

**CHARACTERISTICS**

Collector-to-Emitter Breakdown Voltage:		
With base short-circuited to the emitter and collector		
amperes = -0.3 .....	-70 min	volts
With base open and collector amperes = -1 .....	-55 min	volts
Base-to-Emitter Voltage (with collector-to-emitter volts = -2		
and collector amperes = -5) .....	-0.65	volt
Emitter-to-Base Voltage (with collector-to-base volts = -80		
and emitter current = 0) .....	-1 max	volt
Collector-to-Emitter Saturation Voltage (with collector		
amperes = -12 and base amperes = -2) .....	-0.3	volt
Collector-to-Emitter Reach-Through Voltage .....	-80	volts
Emitter-Cutoff Current (with emitter-to-base volts = -60 and		
collector current = 0) .....	-1	ma

**Collector-Cutoff Current:**

With collector-to-base volts = -2 and emitter current = 0 ..	-100	μa
With collector-to-base volts = -80 and emitter current = 0 ..	-2	ma
Thermal Resistance (junction-to-case) .....	0.35	°C/watt
Thermal Capacity (for pulses in the 1-to-10-millisecond range) ..	0.075	watt-sec/°C
Thermal Time Constant .....	26.25	msec

**In Common-Emitter Circuit**

DC Forward Current-Transfer Ratio (with collector-to-emitter volts = -2):		
With collector amperes = -5 .....	25 to 50	
With collector amperes = -12 .....	20	
Small-Signal Forward-Current-Transfer-Ratio Cutoff		
Frequency (with collector-to-emitter volts = -6 and collector amperes = -5) .....	10	kc

**TYPICAL OPERATION IN POWER-SWITCHING CIRCUIT**

DC Collector Supply Voltage .....	-12	volts
DC Base Supply Voltage .....	6	volts
On DC Collector Current .....	-12	amperes
Turn-On DC Base Current .....	-2	amperes
Turn-Off DC Base Current .....	0	amperes
Switching Time:		
Rise time .....	15	μsec
Fall time .....	15	μsec

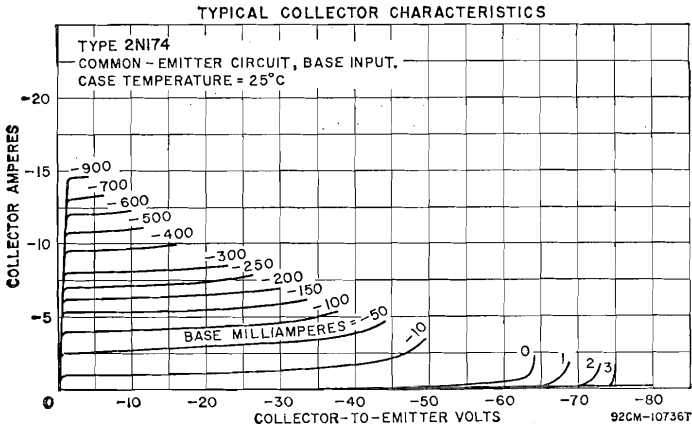

**TRANSISTOR**

Germanium p-n-p type used in low-level preamplifier or input stages of audio-frequency amplifiers. This type is free from microphonism and hum and has a low noise figure. These features make it possible to

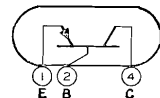

**2N175**

obtain high small-signal sensitivity in transistorized audio equipment such as hearing aids, microphone preamplifiers, and recorders. In addition, the low noise figure and the low input impedance permit the design of audio amplifiers in which the transistor is operated directly from low-level, low-impedance devices such as magnetic microphones and magnetic pickups without an input coupling transformer. JEDEC No. TO-40 package; outline 15, Outlines Section.

**MAXIMUM RATINGS**

Collector-to-Base Voltage (with emitter open) .....	-10 max	volts
Emitter-to-Base Voltage (with collector open) .....	-10 max	volts

Collector Current .....	-2 max	volts
Emitter Current .....	2 max	ma
Transistor Dissipation:	20 max	mw
Ambient-Temperature Range:		
Operating .....	-65 to 50	°C
Storage .....	-65 to 85	°C

**CHARACTERISTICS**

Collector-Cutoff Current (with collector-to-base volts = -25 and emitter current = 0) .....	-12 max	µa
Emitter-Cutoff Current (with emitter-to-base volts = -12 and collector current = 0) .....	-12 max	µa

*In Common-Base Circuit*

Small-Signal Forward-Current-Transfer-Ratio Cutoff Frequency (with collector-to-base volts = -4 and collector ma = -0.5) .....	0.85	Mc
--	------	----

*In Common-Emitter Circuit*

Noise Figure (with collector-to-emitter volts = -4, collector ma = -0.5, and generator resistance = 1000 ohms) .....	6 max	db
Matched-Impedance Power Gain (with collector-to-emitter volts = -4, collector ma = -0.5, input resistance = 2000 ohms, and output resistance = 70000 ohms) .....	43	db

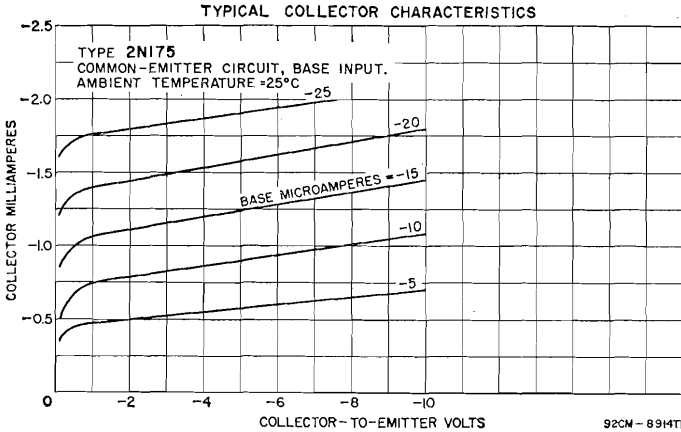

**POWER TRANSISTOR**

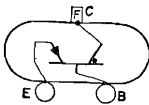

Germanium p-n-p type used in large-signal audio-frequency amplifier applications. It is used in class A power-output stages and class B push-pull amplifier stages in automobile radio receivers. Package is similar to JEDEC No. TO-3; outline 23, Outlines Section.

**2N176**

**MAXIMUM RATINGS**

Collector-to-Base Voltage (with emitter open) .....	-40 max	volts
Collector Current .....	-3 max	amperes
Emitter Current .....	3 max	amperes
Transistor Dissipation:		
At mounting-flange temperatures up to 80°C* .....	10 max	watts
Mounting-Flange-Temperature Range:		
Operating and storage .....	-65 to 90	°C

\* This rating is reduced 1 watt/°C for mounting-flange temperatures above 80°C.

**CHARACTERISTICS**

Collector-to-Emitter Breakdown Voltage (with collector ma = -330 and base short-circuited to emitter) .....	-30 min	volts
Collector-Cutoff Current (with collector-to-base volts = -30 and emitter current = 0) .....	-3 max	ma
Emitter-Cutoff Current (with emitter-to-base volts = -10 and collector current = 0) .....	-2 max	ma
Thermal Resistance: Junction-to-ambient .....	1	°C/watt

**In Common-Emitter Circuit**

DC Forward Current-Transfer Ratio (with collector-to-emitter volts = -2 and collector amperes = -0.5) .....	63	
Small-Signal Forward Current-Transfer Ratio at 1 kilocycle (with collector-to-emitter volts = -2 and collector amperes = -0.5) .....	45	
Small-Signal Input Resistance at 1 kilocycle .....	13.5	ohms

**TYPICAL OPERATION IN CLASS A POWER-AMPLIFIER CIRCUIT**

DC Collector-Supply Voltage .....	-14.4	volts
DC Collector-to-Emitter Voltage .....	-13.7	volts
DC Base-to-Emitter Voltage .....	-0.24	volt
Peak Collector Current .....	-1	ampere
Zero-Signal Collector Current .....	-0.5	ampere
Emitter Resistance .....	1	ohm
Load Impedance .....	25	ohms
Signal Frequency .....	1	kc
Signal-Source Impedance .....	10	ohms
Power Gain .....	35.5	db
Total Harmonic Distortion .....	4	per cent
Zero-Signal Collector Dissipation .....	6.83	watts
Maximum-Signal Power Output .....	2	watts

**2N206**

See List of Discontinued Transistors at end of Technical Data Section for abbreviated data.

**TRANSISTOR**

Germanium p-n-p type used in low-power audio-frequency amplifier applications. JEDEC No. TO-1 package; outline 4, Outlines Section. This type is electrically identical with type 2N104.

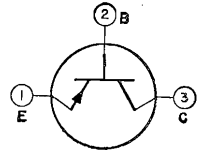

**2N215**

**TRANSISTOR**

Germanium p-n-p type used in large-signal audio-frequency amplifier applications. It is used in class B push-pull power-output stages of battery-operated portable radio receivers and audio amplifiers and in

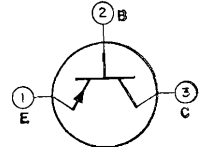

**2N217**

class A high-gain driver stages. JEDEC No. TO-1 package; outline 4, Outlines Section. This type is electrically identical with type 2N109.

**TRANSISTOR**

Germanium p-n-p type used primarily in 455-kilocycle intermediate-frequency amplifier applications in battery-operated portable radio receivers and automobile radio receivers operating from either a 6-

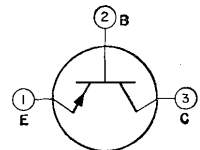

**2N218**

volt or a 12-volt supply. JEDEC No. TO-1 package; outline 4, Outlines Section. This type is electrically identical with type 2N139.

**TRANSISTOR**

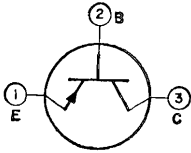

Germanium p-n-p type used primarily in converter and mixer-oscillator applications in AM battery-operated portable radio receivers and automobile radio receivers operating from either a 6-volt or a 12-volt supply. JEDEC No. TO-1 package; outline 4, Outlines Section. This type is electrically identical with type 2N140.

**2N219**

**TRANSISTOR**

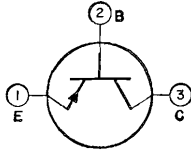

Germanium p-n-p low-noise type used in low-level preamplifier or input stages of audio-frequency amplifiers. JEDEC No. TO-1 package; outline 4, Outlines Section. This type is electrically identical with type 2N175.

**2N220**

See List of Discontinued Transistors at end of Technical Data Section for abbreviated data.

**2N247**

See List of Discontinued Transistors at end of Technical Data Section for abbreviated data.

**2N269**

**TRANSISTOR**

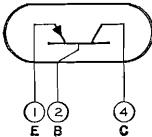

Germanium p-n-p type used in large-signal audio-frequency amplifier applications. It is used in single-ended or double-ended output stages, in high-gain class A driver stages of radio receivers and audio amplifiers, and in class B push-pull audio-amplifier service. This type is also used in battery-operated equipment such as radio receivers, communication receivers, and phonographs. Package is similar to JEDEC No. TO-7; outline 25, Outlines Section.

**2N270**

**MAXIMUM RATINGS**

Collector-to-Base Voltage (with emitter open)	-25 max	volts
Emitter-to-Base Voltage (with collector open)	-12 max	volts
Collector Current:		
Peak	-150 max	ma
DC	-75 max	ma
Emitter Current:		
Peak	150 max	ma
DC	75 max	ma
Transistor Dissipation:		
At ambient temperatures up to 25°C	250 max	mw
At ambient temperature of 55°C	150 max	mw
At ambient temperature of 71°C	60 max	mw
Ambient-Temperature Range:		
Operating	-65 to 71	°C
Storage	-65 to 85	°C

**CHARACTERISTICS**

*In Common-Emitter Circuit*

DC Forward Current-Transfer Ratio (with collector-to-emitter volts = -1 and collector ma = -150)

70

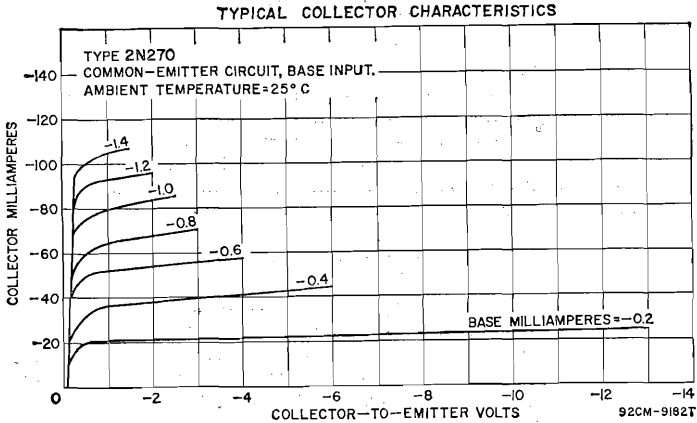

**TYPICAL OPERATION IN CLASS A AF AMPLIFIER CIRCUIT**

DC Collector Supply Voltage	-9	volts
DC Collector-to-Emitter Voltage	-6.7	volts
DC Base-to-Emitter Voltage	-0.19	volt
DC Collector Current	-19	ma
Emitter Resistance	400	ohms
Load Impedance	400	ohms
Signal Frequency	1	kc
Power Gain	35	db
Total Harmonic Distortion:		
At power output = 60 mw	10 max per cent	
At power output = 10 mw	4 max per cent	
Zero-Signal Transistor Dissipation	128	mw
Maximum-Signal Power Output	60	mw

**TYPICAL OPERATION IN CLASS B PUSH-PULL AF AMPLIFIER CIRCUIT**

*Values are for two transistors except as noted*

DC Collector Supply Voltage	-12	volts
Zero-Signal DC Base-to-Emitter Voltage	-0.11	volt
Peak Collector Current per transistor	-110	ma
Maximum-Signal DC Collector Current per transistor	-35	ma
Zero-Signal DC Collector Current per transistor	-2	ma
Signal-Source Impedance per base	1000	ohms
Load Impedance per collector	150	ohms
Signal Frequency	1	kc
Circuit Efficiency	75	per cent
Power Gain	32	db
Total Harmonic Distortion:		
At power output = 500 mw	10 max per cent	
At power output = 10 mw	5 max per cent	
Maximum-Signal Power Output	500	mw

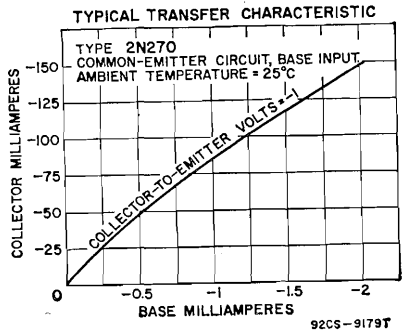
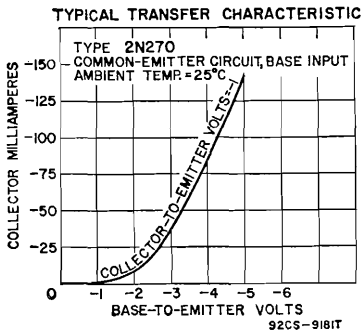



TRANSISTOR

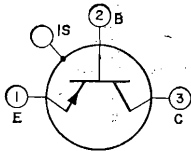

Germanium p-n-p type used in rf and if amplifier circuits; oscillator, mixer, and converter circuits; and low-level video-amplifier circuits in industrial and military equipment. It is used in the design of rf circuits

2N274

having high input-circuit efficiency, excellent operating stability, good automatic-gain-control capabilities over a wide range of input-signal levels, and good signal-to-noise ratio. The drift-field construction provides low base resistance and collector-transition capacitance, and improves performance at higher frequencies. The center lead connected internally to the metal case provides integral shielding which minimizes interlead capacitance and coupling to adjacent circuit components. For curves of typical collector characteristics and for video-amplifier circuit, refer to type 2N384. JEDEC No. TO-44 package; outline 16, Outlines Section.

MAXIMUM RATINGS

Collector-to-Base Voltage (with emitter open)	-40 max	volts
Collector-to-Emitter Voltage (with base-to-emitter volts = 0.5)	-40 max	volts
Emitter-to-Base Voltage (with collector open)	-0.5 max	volt
Collector Current	-10 max	ma
Emitter Current	10 max	ma
Transistor Dissipation:		
At ambient temperatures up to 25°C	120 max	mw
At ambient temperatures above 25°C	See curve	page 80
At case temperatures up to 25°C (with heat sink)	240 max	mw
At case temperatures above 25°C	See curve	page 80
Temperature Range:		
Operating and storage	-65 to 100	°C

CHARACTERISTICS

Collector-to-Base Breakdown Voltage (with collector $\mu_a = -50$ and emitter current = 0)	-80	volts
Collector-to-Emitter Reach-Through Voltage (with emitter-to-base volts = -0.5)	-80	volts
Collector-Cutoff Current (with collector-to-base volts = -12 and emitter current = 0)	-4	$\mu_a$
Emitter-Cutoff Current (with emitter-to-base volts = -0.5 and collector current = 0)	-1	$\mu_a$
Thermal Resistance:		
Junction-to-case	0.31 max	°C/mw
Junction-to-ambient	0.62 max	°C/mw

In Common-Base Circuit

Small-Signal Forward-Current-Transfer-Ratio Cutoff Frequency (with collector-to-base volts = -12 and emitter $ma = 1.5$ )	30	Mc
Collector-to-Base Capacitance (with collector-to-base volts = -12 and emitter current = 0)	2	pf

In Common-Emitter Circuit

Small-Signal Forward Current-Transfer Ratio at 1 kilocycle (with collector-to-emitter volts = -12 and emitter $ma = 1.5$ )	60	
Input Resistance with ac output circuit shorted:		
With collector-to-emitter volts = -12, emitter $ma = 1.5$ , and signal frequency = 12.5 Mc	150	ohms
With collector-to-emitter volts = -12, emitter $ma = 1.5$ , and signal frequency = 1.5 Mc	1350	ohms
Output Resistance with ac input circuit shorted:		
With collector-to-emitter volts = -12, emitter $ma = 1.5$ , and signal frequency = 12.5 Mc	4000	ohms
With collector-to-emitter volts = -12, emitter $ma = 1.5$ , and signal frequency = 1.5 Mc	70000	ohms
Power Gain:		
With collector-to-emitter volts = -12, emitter $ma = 1.5$ , and signal frequency = 12.5 Mc	22	db
With collector-to-emitter volts = -12, emitter $ma = 1.5$ , and signal frequency = 1.5 Mc	45	db

**TYPICAL OPERATION IN VIDEO-AMPLIFIER CIRCUIT**

DC Collector-to-Emitter Voltage .....	-12	volts
DC Emitter Current .....	5.8	ma
Source Impedance .....	150	ohms
Capacitive Load .....	16	pf
Frequency Response .....	20 cps to 9 Mc	
Pulse-Rise Time .....	0.039	μsec
Voltage Gain .....	26	db
Maximum Peak-to-Peak Output Voltage .....	20	volts

**POWER TRANSISTOR**

**2N277**

Germanium p-n-p type used in a wide variety of switching and amplifier applications in industrial and military equipment requiring transistors having high voltage, current, and dissipation values. It is used in

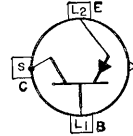

power-switching, voltage- and current-regulating, dc-to-dc converter, inverter, power-supply and relay- and solenoid-actuating circuits; and in low-frequency oscillator and audio-amplifier service. This type is designed to provide satisfactory performance under extreme environmental conditions of temperature, moisture, and altitude; it is stud-mounted to provide positive heat-sink contact, and has a cold-weld seal to insure reliable performance under severe environmental conditions. JEDEC No. TO-36 package; outline 14, Outlines Section. This type is identical with type 2N173 except for the following items:

**MAXIMUM RATINGS**

Collector-to-Base Voltage (with emitter-to-base volts = -1.5) ..	-40 max	volts
Emitter-to-Base Voltage (with collector open) .....	-20 max	volts

**CHARACTERISTICS**

Collector-to-Emitter Breakdown Voltage:  
 With base short-circuited to emitter and collector amperes = -0.3

With base open and collector amperes = -0.3 .....	-40 min	volts
With base open and collector amperes = -1 .....	-40	volts
Emitter-to-Base Voltage (with collector-to-base volts = -40 and emitter current = 0) .....	-25 min	volts
Collector-to-Emitter Reach-Through Voltage .....	-1 max	volt
Emitter-Cutoff Current (with emitter-to-base volts = -20 and collector current = 0) .....	-40 min	volts
Collector-Cutoff Current (with emitter-to-base volts = -20 and collector current = 0) .....	-1	ma
Collector-Cutoff Current (with collector-to-base volts = -40 and emitter current = 0) .....	-2	ma

**TYPICAL COLLECTOR CHARACTERISTICS**

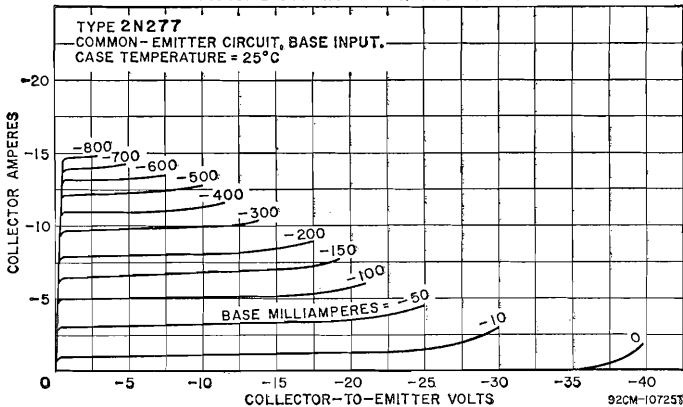

**POWER TRANSISTOR**

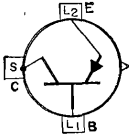

Germanium p-n-p type used in a wide variety of switching and amplifier applications in industrial and military equipment requiring transistors having high voltage, current, and dissipation values. It is used in

**2N278**

power-switching, voltage- and current-regulating, dc-to-dc converter, inverter, power-supply, and relay- and solenoid-actuating circuits; and in low-frequency oscillator and audio-amplifier service. This type is designed to provide satisfactory performance under extreme environmental conditions of temperature, moisture, and altitude; it is stud-mounted to provide positive heat-sink contact, and has a cold-weld seal to insure reliable performance under severe environmental conditions. JEDEC No. TO-36 package; outline 14, Outlines Section. This type is identical with type 2N173 except for the following items:

**MAXIMUM RATINGS**

Collector-to-Base Voltage (with emitter-to-base volts = -1.5) ..	-50 max	volts
Emitter-to-Base Voltage (with collector open) .....	-30 max	volts

**TYPICAL COLLECTOR CHARACTERISTICS**

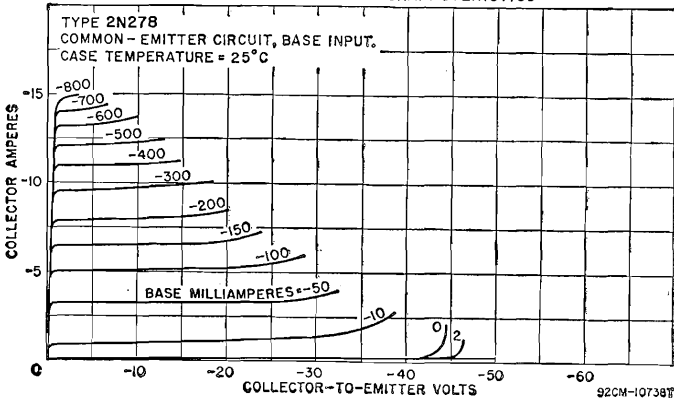

**CHARACTERISTICS**

Collector-to-Emitter Breakdown Voltage:		
With base short-circuited to the emitter and collector amperes = -0.3		
With base open and collector amperes = -0.3	-45 min	volts
With base open and collector amperes = -1	-45	volts
Emitter-to-Base Voltage (with collector-to-base volts = -50 and emitter current = 0)	-30 min	volts
Collector-to-Emitter Reach-Through Voltage	-1 max	volt
Emitter-Cutoff Current (with emitter-to-base volts = -30 and collector current = 0)	-50 min	volts
Collector-Cutoff Current (with collector-to-base volts = -50 and emitter current = 0)	-1	ma
	-2	ma

See List of Discontinued Transistors at end of Technical Data Section for abbreviated data.

**2N301**  
**2N301A**

## POWER TRANSISTOR

**2N307**

Germanium p-n-p type used in large-signal audio-frequency amplifier applications such as class A and class B audio-frequency amplifiers, class A driver amplifiers, low-frequency oscillators, converters, in-

verters, power supplies, light flashers, and communications systems. Package is similar to JEDEC No. TO-3; outline 26, Outlines Section.

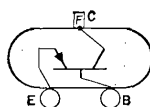

## MAXIMUM RATINGS

Collector-to-Base Voltage (with emitter open)	.....	-35 max	volts
Collector-to-Emitter Voltage	.....	-35 max	volts
Collector Current	.....	-1 max	ma
Emitter Current	.....	1 max	ma
Transistor Dissipation:			
At mounting-flange temperatures up to 25°C	.....	10 max	watts
At mounting-flange temperatures above 25°C	.....	See curve	page 80
Mounting-Flange Temperature Range:			
Operating and storage	.....	-65 to 75	°C

## CHARACTERISTICS

Collector-to-Emitter Saturation Voltage (with collector ma = -200 and base ma = -20)	.....	-1 max	volt
Collector-Cutoff Current (with collector-to-emitter volts = -35 and external base-emitter resistance = 30 ohms)	.....	-15 max	ma
Thermal Resistance:			
Junction-to-mounting flange	.....	5	°C/watt

*In Common-Emitter Circuit*

DC Forward Current-Transfer Ratio (with collector-to-emitter volts = -1.5 and collector ma = -200)	.....	20	
Small-Signal Forward-Current-Transfer-Ratio Cutoff Frequency (with collector-to-emitter volts = -1.5 and collector ma = 200)	.....	3	kc

**2N331**

See List of Discontinued Transistors at end of Technical Data Section for abbreviated data.

## POWER TRANSISTOR

**2N351**

Germanium p-n-p type used in large-signal audio-frequency amplifier applications. It is used primarily in class A power-output stages and class B push-pull amplifier stages in automobile radio receivers. Pack-

age is similar to JEDEC No. TO-3; outline 23, Outlines Section. This type is identical with type 2N176 except for the following items:

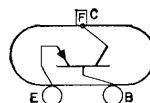

## CHARACTERISTICS

*In Common-Emitter Circuit*

DC Forward-Current Transfer Ratio (with collector-to-emitter volts = -2 and collector amperes = -0.7)	.....	65	
Small-Signal Forward Current-Transfer Ratio at 1 kilocycle (with collector-to-emitter volts = -2 and collector amperes = -0.7)	.....	45	
Small-Signal Input Resistance	.....	13	ohms

## TYPICAL OPERATION IN CLASS A POWER-AMPLIFIER CIRCUIT

Mounting-flange temperature of 80°C

DC Collector Supply Voltage	.....	-14.4	volts
DC Collector-to-Emitter Voltage	.....	-13.2	volts
DC Base-to-Emitter Voltage	.....	-0.3	volt
Peak Collector Current	.....	-1.4	amperes
Zero-Signal DC Collector Current	.....	-0.7	ampere
Emitter Resistance	.....	1	ohm

Load Impedance .....	15	ohms
Signal Frequency .....	1	kc
Signal-Source Impedance .....	10	ohms
Power Gain .....	33.5	db
Total Harmonic Distortion at power output of 4 watts .....	5	per cent
Zero-Signal Transistor Dissipation .....	9.25	watts
Maximum-Signal Power Output .....	4	watts

See List of Discontinued Transistors at end of Technical Data Section for abbreviated data. **2N356**

See List of Discontinued Transistors at end of Technical Data Section for abbreviated data. **2N357**

See List of Discontinued Transistors at end of Technical Data Section for abbreviated data. **2N358**

**TRANSISTOR**

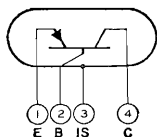

Germanium p-n-p type used as an amplifier in AM broadcast-band battery-operated portable radio receivers and short-wave receivers. JEDEC No. TO-7 package; outline 7, Outlines Section.

**2N370**

**MAXIMUM RATINGS**

Collector-to-Base Voltage (with emitter open) .....	-20 max	volts
Emitter-to-Base Voltage (with collector open) .....	-1.5 max	volts
Collector Current .....	-10 max	ma
Emitter Current .....	10 max	ma
Collector Dissipation:		
At ambient temperatures up to 25°C .....	80 max	mw
At ambient temperature of 55°C .....	40 max	mw
At ambient temperature of 71°C .....	20 max	mw
Ambient-Temperature Range:		
Operating .....	-65 to 71	°C
Storage .....	-65 to 85	°C

**CHARACTERISTICS**

Collector-Cutoff Current (with collector-to-base volts = -12 and emitter current = 0) .....	-20 max	µa
Emitter-Cutoff Current (with emitter-to-base volts = -1.5 and collector current = 0) .....	-50 max	µa

**In Common-Base Circuit**

Small-Signal Forward Current-Transfer Ratio at 1 kilocycle (with collector-to-base volts = -12 and collector ma = 1) ..	0.984	
Small-Signal Forward-Current-Transfer-Ratio Cutoff Frequency (with collector-to-base volts = -12 and collector ma = 1) ..	30	Mc
Interlead Capacitance between collector and base leads (with interlead shield grounded and all leads cut to 1/16 inch) .....	0.3	pf

**In Common-Emitter Circuit**

DC Forward Current-Transfer Ratio at 1 kilocycle (with collector-to-emitter volts = -12 and collector ma = -1) ....	60	
Gain-Bandwidth Product (with collector-to-emitter volts = -12 and collector ma = -1) .....	132	Mc

**TYPICAL OPERATION**

Frequency .....	1.5	10	20	Mc
DC Collector-to-Emitter Voltage .....	-12	-12	-12	volts
DC Collector Current .....	1	1	1	ma
Input Resistance .....	1750	200	100	ohms
Output Resistance .....	180000	18000	11000	ohms
Maximum Power Gain .....	50.5	26.2	17	db
Maximum Useful Power Gain in an unneutralized circuit .....	31	17.6	12.5	db
Intrinsic Transconductance .....	37800	21400	13700	µmhos
Collector Transition Capacitance .....	1.7	1.7	1.7	pf

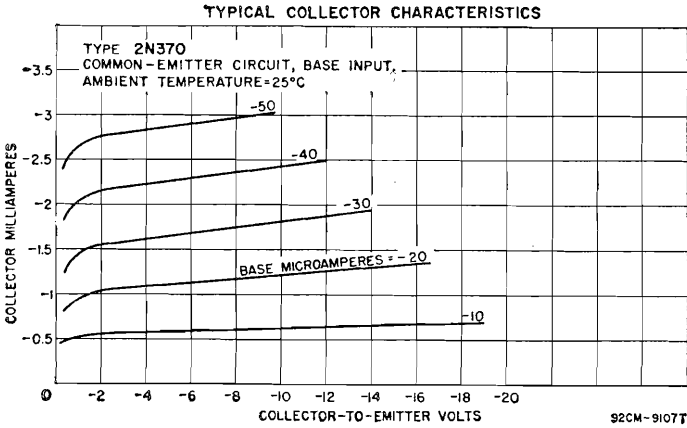

**TRANSISTOR**

**2N371**

Germanium p-n-p type used as a radio-frequency oscillator in AM broadcast-band battery-operated portable radio receivers and short-wave receivers. JEDEC No. TO-7 package; outline 7, Outlines Section.

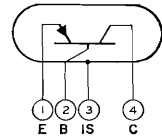

Ratings and characteristics for this type are the same as for type 2N370 except for the following items:

**MAXIMUM RATINGS**

Emitter-to-Base Voltage (with collector open) ..... -0.5 max volt

**CHARACTERISTICS**

Emitter-Cutoff Current (with emitter-to-base volts = -0.5 and collector current = 0) ..... -50 max  $\mu$ a

**TRANSISTOR**

**2N372**

Germanium p-n-p type used as a radio-frequency mixer in AM broadcast-band battery-operated portable radio receivers and short-wave receivers. JEDEC No. TO-7 package; outline 7, Outlines Section.

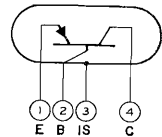

This type is electrically identical with type 2N370 except for the following items:

**MAXIMUM RATINGS**

Emitter-to-Base Voltage (with collector open) ..... -0.5 max volt

**CHARACTERISTICS**

Emitter-Cutoff Current (with emitter-to-base volts = -0.5 and collector current = 0) ..... -50  $\mu$ a

**2N373**

See List of Discontinued Transistors at end of Technical Data Section for abbreviated data.

**2N374**

See List of Discontinued Transistors at end of Technical Data Section for abbreviated data.

**POWER TRANSISTOR**

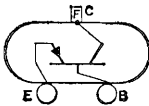

**2N376**

Germanium p-n-p type used in large-signal audio-frequency amplifier applications. It is used primarily in class A power-output stages and class B push-pull amplifier stages of automobile radio receivers. Package is similar to JEDEC No. TO-3; outline 23, Outlines Section. This type is identical with type 2N176 except for the following items:

**CHARACTERISTICS**

*In Common-Emitter Circuit*

Small-Signal Forward Current-Transfer Ratio at 1 kilocycle (with collector-to-emitter volts = -2 and collector amperes = -0.7)	60	
DC Forward Current-Transfer Ratio (with collector-to-emitter volts = -2 and collector amperes = -0.7)	78	
Small-Signal Input Resistance	16	ohms

**TYPICAL OPERATION IN CLASS A POWER-AMPLIFIER CIRCUIT**

*Mounting-flange temperature of 80°C*

DC Collector Supply Voltage	-14.4	volts
DC Collector-to-Emitter Voltage	-13.2	volts
DC Base-to-Emitter Voltage	-0.3	volt
Peak Collector Current	-1.4	amperes
Zero-Signal DC Collector Current	-0.7	ampere
Emitter Resistance	1	ohm
Load Impedance	15	ohms
Signal Frequency	1	kc
Signal-Source Impedance	10	ohms
Power Gain	35	db
Total Harmonic Distortion	5	per cent
Zero-Signal Transistor Dissipation	9.25	watts
Maximum-Signal Power Output	4	watts

**TRANSISTOR**

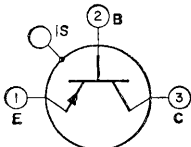

**2N384**

Germanium p-n-p type used in rf- and if-amplifier circuits; oscillator, mixer, and converter circuits; and low-level video-amplifier circuits in industrial and military equipment. It is used in the design of rf circuits having high input-circuit efficiency, excellent operating stability, good automatic-gain-control capabilities over a wide range of input-signal levels, and good signal-to-noise ratio. The drift-field construction provides low base resistance and collector-transition capacitance, and improves performance at higher frequencies. The center lead internally connected to the metal case provides integral shielding which minimizes interlead capacitance and coupling to adjacent circuit components. JEDEC No. TO-44 package; outline 16, Outlines Section.

**MAXIMUM RATINGS**

Collector-to-Base Voltage (with emitter open)	-40 max	volts
Collector-to-Emitter Voltage (with base-to-emitter volts = 0.5)	-40 max	volts
Emitter-to-Base Voltage (with collector open)	-0.5 max	volt
Collector Current	-10 max	ma
Emitter Current	10 max	ma
Transistor Dissipation:		
At case temperatures up to 25°C	240 max	mw
At case temperatures above 25°C	See curve	page 80
At ambient temperatures up to 25°C	120 max	mw
At ambient temperatures above 25°C	See curve	page 80
Ambient-Temperature Range:		
Operating (junction) and storage	-65 to 100	°C

CHARACTERISTICS

Collector-to-Base Breakdown Voltage (with collector $\mu a = -50$ and emitter current = 0)	-80	volts
Collector-to-Emitter Reach-Through Voltage (with emitter-to-base volts = -0.5)	-80	volts
Collector-Cutoff Current (with collector-to-base volts = -12 and emitter current = 0)	-4	$\mu a$
Emitter-Cutoff Current (with emitter-to-base volts = -0.5 and collector current = 0)	-1	$\mu a$
Thermal Resistance:		
Junction-to-case	0.31 max	$^{\circ}C/mw$
Junction-to-ambient	0.62 max	$^{\circ}C/mw$

In Common-Base Circuit

Small-Signal Forward-Current-Transfer-Ratio Cutoff Frequency (with collector-to-base volts = -12 and emitter ma = -1.5)	100	Mc
Input Resistance with ac output circuit shorted (with collector-to-base volts = -12, emitter ma = 1.5, and signal frequency = 50 Mc)	30	ohms
Output-Resistance with ac input circuit shorted (with collector-to-base volts = -12, emitter ma = 1.5, and signal frequency = 50 Mc)	5000	ohms
Collector-to-Base Capacitance (with collector-to-base volts = -12, and emitter current = 0)	2	pf
Power Gain (with collector-to-base volts = -12, emitter ma = 1.5, signal frequency = 50 Mc)	18	db

In Common-Emitter Circuit

Small-Signal Forward Current-Transfer Ratio at 1 kilocycle (with collector-to-emitter volts = -12 and emitter ma = 1.5)	60	
Input Resistance with ac output circuit shorted:		
With collector-to-emitter volts = -12, emitter ma = 1.5, and signal frequency = 30 Mc	50	ohms
With collector-to-emitter volts = -12, emitter ma = 1.5, and signal frequency = 12.5 Mc	250	ohms
Output Resistance with ac input circuit shorted:		
With collector-to-emitter volts = -12, emitter ma = 1.5, and signal frequency = 30 Mc	5000	ohms
With collector-to-emitter volts = -12, emitter ma = 1.5, and signal frequency = 12.5 Mc	16000	ohms
Power Gain:		
With collector-to-emitter volts = -12, emitter ma = 1.5, and signal frequency = 30 Mc	20	db
With collector-to-emitter volts = -12, emitter ma = 1.5, and signal frequency = 12.5 Mc	28	db

TYPICAL COLLECTOR CHARACTERISTICS

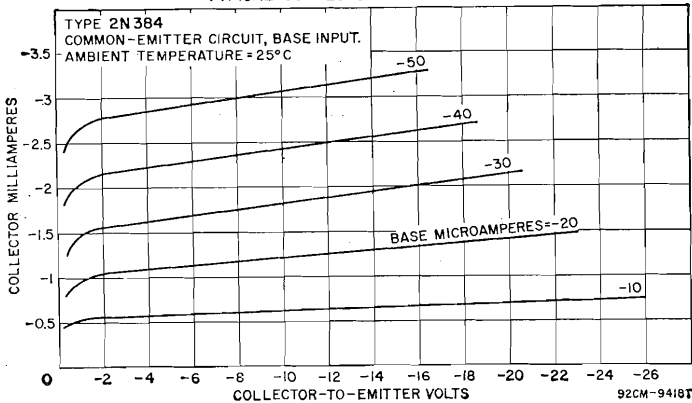



TYPICAL OPERATION IN VIDEO-AMPLIFIER CIRCUIT BELOW

DC Collector-to-Emitter Voltage .....	-12	volts
DC Emitter Current .....	5.8	ma
Source Impedance .....	150	ohms
Capacitive Load .....	16	pf
Frequency Response .....	20 cps to 10 Mc	
Pulse-Rise Time .....	0.035	μsec
Voltage Gain .....	26	db
Maximum Peak-to-Peak Output Voltage .....	20	volts

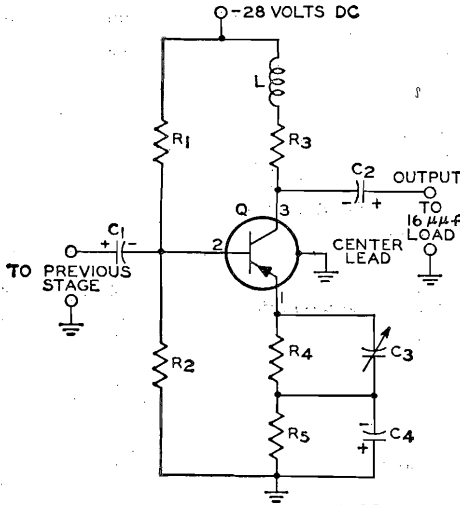

- C<sub>1</sub> = 25 μf, 12 volts
- C<sub>2</sub> = 25 μf, 25 volts
- C<sub>3</sub> = 100 to 300 μμf (variable)
- C<sub>4</sub> = 100 μf, 12 volts
- L = 30 μh
- R<sub>1</sub> = 20000 ohms, 0.25 watt
- R<sub>2</sub> = 3600 ohms, 0.25 watt
- R<sub>3</sub> = 2000 ohms, 0.25 watt
- R<sub>4</sub> = 62 ohms, 0.25 watt
- R<sub>5</sub> = 620 ohms, 0.25 watt

92CS-10394R1

TRANSISTOR

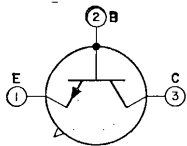

Germanium n-p-n types used in medium-speed switching applications in data-processing equipment. JEDEC No. TO-5 package; outline 6, Outlines Section.

**2N388**  
**2N388A**

MAXIMUM RATINGS

	2N388	2N388A	
Collector-to-Base Voltage (with emitter open) ..	25 max	40 max	volts
Collector-to-Emitter Voltage:			
With external base-to-emitter resistance = 10000 ohms .....	20 max	20 max	volts
With base-to-emitter volts = -0.5 .....	—	40 max	volts
Emitter-to-Base Voltage (with collector open) ..	15 max	15 max	volts
Collector Current .....	200 max	200 max	ma
Transistor Dissipation:			
At ambient temperatures up to 25°C .....	150 max	150 max	mw
At ambient temperatures above 25°C .....	See curve page 80		
Ambient-Temperature Range:			
(Operating and storage) .....	-65 to 100	-65 to 100	°C
Lead Temperature (for 10 seconds maximum) .....	235 max	235 max	°C

CHARACTERISTICS

	2N388	2N388A	
Base-to-Emitter Voltage:			
With collector ma = 200 and base ma = 10 .....	1.5 max	1.5 max	volts
With collector ma = 100 and base ma = 4 .....	0.8 max	0.8 max	volts
Collector-Cutoff Current:			
With collector-to-base volts = 40 and emitter current = 0 .....	—	40 max	μa
With collector-to-base volts = 25 and emitter current = 0 .....	10 max	10 max	μa
With collector-to-base volts = 1 and emitter current = 0 .....	5 max	5 max	μa

*In Common-Emitter Circuit*

Forward Current-Transfer Ratio:		
With collector-to-emitter volts = 0.75		
and collector ma = 200	30 min	30 min
With collector-to-emitter volts = 0.5		
and collector ma = 30	60 to 180	60 to 180

*In Common-Base Circuit*

Forward-Current-Transfer-Ratio Cutoff Frequency (with collector-to-base volts = 6 and collector ma = 1)	5 min	5 min	Mc
Collector-to-Base Capacitance (with collector-to- base volts = 6 and collector ma = 1)	20 max	20 max	pf

**TRANSISTOR**

Germanium p-n-p type used in medium-speed switching applications in data-processing equipment. JEDEC No. TO-5 package; outline 6, Outlines Section.

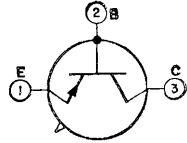

**2N395**

**MAXIMUM RATINGS**

Collector-to-Base Voltage (with emitter open)	-30 max	volts
Collector-to-Emitter Voltage (with external base-to-emitter resistance = 10000 ohms)	-15 max	volts
Emitter-to-Base Voltage (with collector open)	-20 max	volts
Collector Current	-200 max	ma
Transistor Dissipation:		
At ambient temperatures up to 25°C	150 max	mw
At ambient temperatures above 25°C	See curve page 80	
Ambient-Temperature Range:		
Operating	-65 to 85	°C
Storage	-65 to 100	°C
Lead Temperature (for 10 seconds maximum)	230 max	°C

**CHARACTERISTICS**

Collector-to-Emitter Saturation Voltage (with collector ma = 50 and base ma = -5)	-0.2 max	volt
Collector-Cutoff Current (with collector-to-base volts = -15 and emitter current = 0)	-6 max	µA

*In Common-Base Circuit*

Collector-to-Base Capacitance (with collector-to-base volts = -5 and emitter ma = 1)	20 max	pf
Forward-Current-Transfer-Ratio Cutoff Frequency (with collector-to-base volts = -5 and emitter ma = 1)	3 min	Mc

*In Common-Emitter Circuit*

DC Forward Current-Transfer Ratio:		
With collector-to-emitter volts = -1 and collector ma = -10	20 to 150	
With collector-to-emitter volts = -0.35 and collector ma = -200	10 min	

**TRANSISTOR**

Germanium p-n-p types used in medium-speed switching applications in data-processing equipment. JEDEC No. TO-5 package; outline 6, Outlines Section. Ratings for these types are the same as for type 2N395

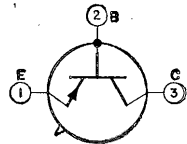

**2N396**  
**2N396A**

except for the following items:

**MAXIMUM RATINGS**

Collector-to-Emitter Voltage:	2N396	2N396A	
With base open	-	-20 max	volts
With external base-to-emitter resistance = 10000 ohms	-20 max	-	volts
Transistor Dissipation:			
At ambient temperatures up to 25°C	150 max	200 max	mw

**CHARACTERISTICS**

Collector-to-Emitter Saturation Voltage (with collector ma = -50 and base ma = -3.3) .....	-0.2 max	volt
Collector-Cutoff Current (with collector-to-base volts = -20 and emitter current = 0) .....	-6 max	μa

*In Common-Base Circuit*

Collector-to-Base Capacitance (with collector-to-base volts = -5 and emitter ma = 1) .....	20 max	pf
Forward-Current-Transfer-Ratio Cutoff Frequency (with collector-to-base volts = -5 and emitter ma = 1) .....	5 min	Mc

*In Common-Emitter Circuit*

DC Forward Current-Transfer Ratio:

With collector-to-emitter volts = -1 and collector ma = -10	30 to 150
With collector-to-emitter volts = -0.35 and collector ma = -200	15 min

**TRANSISTOR**

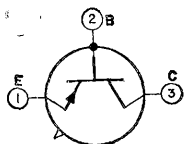

Germanium p-n-p type used in medium-speed switching applications in data-processing equipment. JEDEC No. TO-5 package; outline 6, Outlines Section. This type is identical with type 2N395 except for

**2N397**

the following items:

**CHARACTERISTICS**

Collector-to-Emitter Saturation Voltage (with collector ma = -50 and base ma = -2.5) .....	-0.2 max	volt
--	----------	------

*In Common-Base Circuit*

Forward-Current-Transfer-Ratio Cutoff Frequency (with collector-to-base volts = -5 and emitter ma = 1) .....	10 min	Mc
--	--------	----

*In Common-Emitter Circuit*

Forward Current-Transfer Ratio:

With collector-to-emitter volts = -1 and collector ma = -10	40 to 150
With collector-to-emitter volts = -0.35 and collector ma = -200	20 min

**TRANSISTOR**

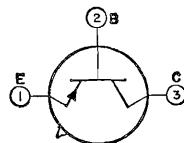

Germanium p-n-p types used for direct high-voltage control of "on-off" devices such as neon indicators, relays, incandescent-lamp indicators, and indicating counters of electronic computers. JEDEC No. TO-5

**2N398**  
**2N398A**  
**2N398B**

package; outline 6, Outlines Section.

**MAXIMUM RATINGS**

	2N398	2N398A	2N398B	
Collector-to-Base Voltage (with emitter open) .....	-105 max	-105 max	-105 max	volts
Collector-to-Emitter Voltage (with emitter-to-base volts = -1) .....	-105 max	-105 max	-105 max	volts
Emitter-to-Base Voltage (with collector open) .....	-50 max	-50 max	-75 max	volts
Collector Current .....	-100 max	-200 max	-200 max	ma
Emitter Current .....	100 max	200 max	200 max	ma
Transistor Dissipation:				
At ambient temperatures up to 25°C .....	50 max	150 max	250 max	mw
At ambient temperatures above 25°C .....		See curve page 80		
Ambient-Temperature Range:				
Operating .....	-65 to 55	-65 to 100	-65 to 100	°C
Storage .....	-65 to 85	-65 to 100	-65 to 100	°C
Lead Temperature .....				

**CHARACTERISTICS**

Base-to-Emitter Saturation Voltage (with collector $i_a = -5$ and base $i_b = -0.25$ )	-0.4 max	-0.4 max	-0.3 max	volt
Collector-to-Emitter Saturation Voltage (with collector $i_a = -5$ and base $i_b = -0.25$ )	-0.35 max	-0.35 max	-0.25 max	volt
Collector-Cutoff Current: With collector-to-base volts = -2.5 and emitter current = 0	-14 max	-14 max	-6 max	$\mu a$
With collector-to-base volts = -105 and emitter current = 0	-50 max	-50 max	-25 max	$\mu a$

*In Common-Base Circuit*

Small-Signal Forward-Current- Transfer-Ratio Cutoff Frequency (with collector-to-base volts = -6 and emitter $i_a = 1$ )	-	-	1 min	Mc
---	---	---	-------	----

*In Common-Emitter Circuit*

DC Forward Current-Transfer Ratio: With collector-to-emitter volts = -0.35 and collector $i_a = -5$	20 min	20 min	-	
With collector-to-emitter volts = -0.25 and collector $i_a = -5$	-	-	20 min	
Small-Signal Forward Current- Transfer Ratio (with collector-to- emitter volts = -6, collector $i_a =$ -1, and frequency = 1 kilocycle)	-	20 min	40 min	

**TRANSISTOR**

Germanium p-n-p types used in medium-speed switching applications in data-processing equipment. These types also have wide application in other low-level, medium-speed "on-off" control circuits.

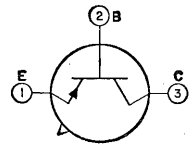

**2N404**  
**2N404A**

JEDEC No. TO-5 package; outline 6, Outlines Section.

**MAXIMUM RATINGS**

	2N404	2N404A	
Collector-to-Base Voltage (with emitter open)	-25 max	-40 max	volts
Collector-to-Emitter Voltage (with emitter-to-base volts = -1)	-24 max	-35 max	volts
Emitter-to-Base Voltage (with collector open)	-12 max	-25 max	volts
Collector Current	-100 max	-150 max	ma
Emitter Current	100 max	150 max	ma
Transistor Dissipation: At ambient temperatures up to 25°C	150 max	150 max	mw
At ambient temperatures above 25°C	See curve page 80		
Ambient-Temperature Range: Operating	-65 to 85	-65 to 100	°C
Storage	-65 to 100	-65 to 100	°C
Lead Temperature (for 10 seconds maximum)	255 max	255 max	°C

**CHARACTERISTICS**

Collector-to-Emitter Saturation Voltage: With collector $i_a = -12$ and base $i_b = -0.4$	-0.15 max		volt
With collector $i_a = -24$ and base $i_b = -1$	-0.2 max		volt
Base-to-Emitter Saturation Voltage: With collector $i_a = -12$ and base $i_b = -0.4$	-0.35 max		volt
With collector $i_a = -24$ and base $i_b = -1$	-0.40 max		volt
Collector-Cutoff Current (with collector-to-base volts = -12 and emitter current = 0)	-5 max		$\mu a$
Stored Base Charge (with collector $i_a = -10$ and base $i_b = -1$ )	-1400 max		pcoul

*In Common-Base Circuit*

Collector-to-Base Capacitance (with collector-to-base volts = -6 and collector current = 0)	20 max		pf
Forward-Current-Transfer-Ratio Cutoff Frequency (with collector-to-base volts = -6 and collector $i_a = -1$ )	4 min		Mc

In Common-Emitter Circuit

DC Forward Current-Transfer Ratio:

With collector-to-emitter volts = -0.2 and collector ma = -24 24 min  
 With collector-to-emitter volts = -0.15 and collector ma = -12 30 min

TRANSISTOR

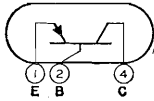

type is electrically

Germanium p-n-p type used in low-power class A audio-frequency driver-amplifier applications in battery-operated portable radio-receivers. JEDEC No. TO-40 package; outline 15, Outlines Section. This is electrically identical with type 2N406.

2N405

TRANSISTOR

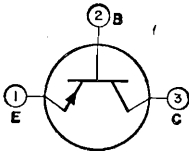

Germanium p-n-p type used in class A audio-frequency driver-amplifier applications in battery-operated portable radio receivers. JEDEC No. TO-1 package; outline 4, Outlines Section.

2N406

MAXIMUM RATINGS

Collector-to-Base Voltage (with emitter open) .....	-20 max	volts
Collector-to-Emitter Voltage .....	-18 max	volts
Emitter-to-Base Voltage (with collector open) .....	-2.5 max	volts
Collector Current .....	-35 max	ma
Emitter Current .....	35 max	ma
Collector Dissipation:		
At ambient temperatures up to 25°C .....	150 max	mw
At ambient temperature of 55°C .....	50 max	mw
At ambient temperature of 71°C .....	20 max	mw
Ambient Temperature:		
Operating .....	-65 to 71	°C
Storage .....	-65 to 85	°C

TYPICAL COLLECTOR CHARACTERISTICS

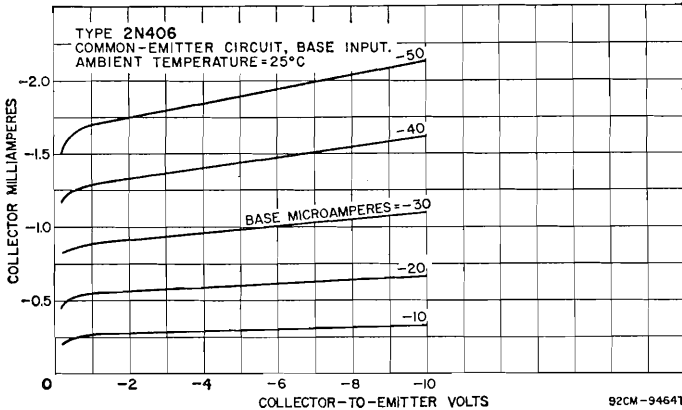

CHARACTERISTICS

Collector-Cutoff Current (with collector-to-base volts = -12 and emitter current = 0) .....	-14 max	µa
Emitter-Cutoff Current (with emitter-to-base volts = -2.5 and collector current = 0) .....	-14 max	µa

92CM-9464TI

**In Common-Base Circuit**

Small-Signal Forward-Current-Transfer-Ratio Cutoff Frequency  
(with collector-to-base volts = -6 and collector ma = -1) .. 650 kc

**In Common-Emitter Circuit**

DC Collector-to-Emitter Voltage ..... -6 volts  
 DC Collector Current ..... -1 ma  
 Power Gain (with load resistance of 8500 ohms and input  
 resistance of 750 ohms) ..... 43 db

**TRANSISTOR**

**2N407**

Germanium p-n-p type used in class A output stages and class B push-pull output stages of battery-operated portable radio receivers and audio amplifiers. JEDEC No. TO-40 package; outline 15, Outlines Section.

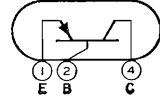

This type is electrically identical with type 2N408.

**TRANSISTOR**

**2N408**

Germanium p-n-p type used in class A output stages and class B push-pull output stages of battery-operated portable radio receivers and audio amplifiers. JEDEC No. TO-1 package; outline 4, Outlines Section.

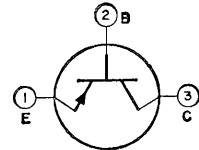

For curves of collector characteristics and transfer characteristics, refer to type 2N109.

**MAXIMUM RATINGS**

Collector-to-Base Voltage (with emitter open) ..... -20 max volts  
 Collector-to-Emitter Voltage ..... -18 max volts  
 Emitter-to-Base Voltage (with collector open) ..... -2.5 max volts  
 Collector Current ..... -70 max ma  
 Emitter Current ..... 70 max ma  
 Collector Dissipation:  
 At ambient temperatures up to 25°C ..... 150 max mw  
 At ambient temperature of 55°C ..... 50 max mw  
 At ambient temperature of 71°C ..... 20 max mw  
 Ambient-Temperature Range:  
 Operating ..... -65 to 71 °C  
 Storage ..... -65 to 85 °C

**CHARACTERISTICS**

Collector-Cutoff Current (with collector-to-base volts = -12  
 and emitter current = 0) ..... -14 max μa  
 Emitter-Cutoff Current (with emitter-to-base volts = -1.5  
 and collector current = 0) ..... -14 max μa

**In Common-Emitter Circuit**

DC Forward Current-Transfer Ratio (with collector-to-emitter  
 volts = -1 and collector ma = -50) ..... 75

**TYPICAL OPERATION IN CLASS B AF AMPLIFIER CIRCUIT**

*Values are for two transistors except as noted*

DC Collector Supply Voltage ..... -4.5 -9 volts  
 Base-to-Emitter Voltage ..... -0.15 -0.15 volt  
 Peak Collector Current (Approx.) per transistor ..... -35 -40 ma  
 Maximum-Signal DC Collector Current  
 (Approx.) per transistor ..... -11.5 -13 ma  
 Zero-Signal DC Collector Current  
 (Approx.) per transistor ..... -2 -2 ma  
 Signal Frequency ..... 1 1 kc  
 Signal-Source Impedance per base ..... 375 375 ohms  
 Load Impedance per collector ..... 100 200 ohms  
 Power Gain ..... 30 33 db  
 Circuit Efficiency ..... 60 69 per cent  
 Total Harmonic Distortion ..... 10 max 10 max per cent  
 Maximum-Signal Power Output ..... 75 160 mw

TRANSISTOR

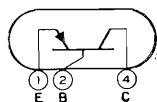

Germanium p-n-p type used in 455-kilocycle intermediate-frequency amplifier applications in battery-operated portable radio receivers. JEDEC No. TO-40 package; outline 15, Outlines Section. This type is electrically identical with type 2N410.

2N409

TRANSISTOR

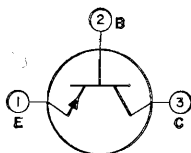

Germanium p-n-p type used in 455-kilocycle intermediate-frequency amplifier applications in battery-operated portable radio receivers. JEDEC No. TO-1 package; outline 4, Outlines Section. For curves of collector characteristics, refer to type 2N139.

2N410

MAXIMUM RATINGS

Collector-to-Base Voltage (with emitter open) .....	-13 max	volts
Emitter-to-Base Voltage (with collector open) .....	-0.5 max	volt
Collector Current .....	-15 max	ma
Emitter Current .....	15 max	ma
Collector Dissipation:		
At ambient temperatures up to 25°C .....	80 max	mw
At ambient temperature of 55°C .....	35 max	mw
At ambient temperature of 71°C .....	10 max	mw
Ambient-Temperature Range:		
Operating .....	-65 to 71	°C
Storage .....	-65 to 85	°C

CHARACTERISTICS

Collector-to-Base Breakdown Voltage (with collector $\mu$ a = -10 and emitter current = 0) .....	-13 min	volts
Collector-Cutoff Current (with collector-to-base volts = -13 and emitter current = 0) .....	-10 max	$\mu$ a
Emitter-Cutoff Current (with emitter-to-base volts = -0.5 and collector current = 0) .....	-12 max	$\mu$ a

In Common-Base Circuit

Small-Signal Forward Current-Transfer Ratio at 1 kilocycle:		
With collector-to-base volts = -9 and collector ma = -0.5 ..	0.978	
With collector-to-base volts = -9 and collector ma = -1 .....	0.98	
Small-Signal Forward-Current-Transfer-Ratio Cutoff Frequency at 1 kilocycle:		
With collector-to-base volts = -9 and collector ma = -0.5 ..	6.8	Mc
With collector-to-base volts = -9 and collector ma = -1 .....	6.7	Mc

In Common-Emitter Circuit

DC Forward Current-Transfer Ratio at 1 kilocycle:		
With collector-to-emitter volts = -9 and collector ma = -0.5 ..	45	
With collector-to-emitter volts = -9 and collector ma = -1 ..	48	

TYPICAL OPERATION IN 455-KC IF AMPLIFIER CIRCUIT

DC Collector-to-Emitter Voltage .....	-9		volts
DC Emitter Current .....	0.5	1	ma
Input Resistance .....	1000	500	ohms
Output Resistance .....	70000	30000	ohms
Spot Noise Factor .....	4.5	4.5	db
Maximum Power Gain .....	38.8	37.8	db
Useful Power Gain .....	28.4	31.2	db

**TRANSISTOR**

**2N411**

Germanium p-n-p type used in converter and mixer-oscillator applications in battery-operated portable radio receivers. JEDEC No. TO-40 package; outline 15, Outlines Section. This type is electrically

identical with type 2N412.

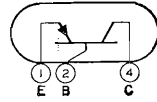

**TRANSISTOR**

**2N412**

Germanium p-n-p type used in converter and mixer-oscillator applications in battery-operated portable radio receivers. JEDEC No. TO-1 package; outline 4, Outlines Section. For curves of collector char-

acteristics, refer to type 2N139.

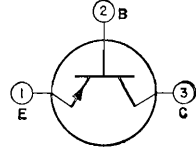

**MAXIMUM RATINGS**

Collector-to-Base Voltage (with emitter open) .....	-13 max	volts
Emitter-to-Base Voltage (with collector open) .....	-0.5 max	volt
Collector Current .....	-15 max	ma
Emitter Current .....	15 max	ma
Collector Dissipation:		
At ambient temperatures up to 25°C .....	80 max	mw
At ambient temperature of 55°C .....	35 max	mw
At ambient temperature of 71°C .....	10 max	mw
Ambient-Temperature Range:		
Operating .....	-65 to 71	°C
Storage .....	-65 to 85	°C

**CHARACTERISTICS**

Collector-to-Base Breakdown Voltage (with collector $\mu_a = -10$ and emitter current = 0) .....	-13 min	volts
Collector-Cutoff Current (with collector-to-base volts = -13 and emitter current = 0) .....	-10 max	$\mu_a$
Emitter-Cutoff Current (with emitter-to-base volts = -0.5 and collector current = 0) .....	-12 max	$\mu_a$

*In Common-Emitter Circuit*

DC Forward Current-Transfer Ratio at 1 kilocycle (with collector-to-emitter volts = -9 and collector ma = -0.6) ....	75
---	----

**TYPICAL OPERATION IN CONVERTER CIRCUIT**

DC Collector-to-Emitter Voltage .....	-9	volts
DC Collector Current .....	-0.6	ma
Input Resistance .....	700	ohms
Output Resistance .....	75000	ohms
RMS Base-to-Emitter Oscillator-Injection Voltage (Approx.) ..	100	mv
Signal Frequency .....	1	Mc
Useful Conversion Power Gain (Approx.) .....	32	db

**TRANSISTOR**

**2N414**

Germanium p-n-p type used in medium-speed switching applications in data-processing equipment. JEDEC No. TO-5; outline 6, Outlines Section.

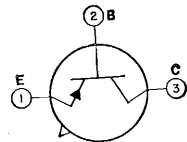

**MAXIMUM RATINGS**

Collector-to-Base Voltage (with emitter open) .....	-30 max	volts
Collector-to-Emitter Voltage:		
With base open .....	-15 max	volts
With base-to-emitter volts = 1 .....	-20 max	volts



Emitter-to-Base Voltage (with collector open) .....	-20 max	volts
Peak Collector Current .....	-400 max	ma
DC Collector Current .....	-200 max	ma
Transistor Dissipation:		
At ambient temperatures up to 25°C .....	150 max	mw
At ambient temperatures above 25°C .....	See curve	page 80
Ambient-Temperature Range:		
Operating and storage .....	-65 to 85	°C
Lead Temperature (for 10 seconds maximum) .....	240 max	°C

**CHARACTERISTICS**

Collector-Cutoff Current (with collector-to-base volts = -12 and emitter current = 0) .....	-5 max	µa
---	--------	----

**In Common-Base Circuit**

Collector-to-Base Capacitance (with collector-to-base volts = -6 and emitter ma = 1) .....	11	pf
Forward-Current-Transfer-Ratio Cutoff Frequency (with collector-to-base volts = -6 and emitter ma = 1) .....	8	Mc
Small-Signal Open-Circuit Reverse Voltage-Transfer Ratio (with collector-base volts = -6, emitter ma = 1, and frequency = 1 kilocycle) .....	0.0005	

**In Common-Emitter Circuit**

Small-Signal Forward Current-Transfer Ratio (with collector-to-emitter volts = -6, emitter ma = 1, and frequency = 1 kilocycle) .....	80
---	----

**POWER TRANSISTOR**

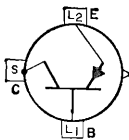

Germanium p-n-p type used in a wide variety of switching and amplifier applications in industrial and military equipment requiring transistors having high voltage, current and dissipation values. It is used in

**2N441**

power-switching, voltage- and current-regulating, dc-to-dc converter, inverter, power-supply, and relay- and solenoid-actuating circuits; and in low-frequency oscillator and audio-amplifier service. This type is designed to provide satisfactory performance under extreme environmental conditions of temperature, moisture, and altitude; it is stud-mounted to provide positive heat-sink contact, and has a cold-weld seal to insure reliable performance under severe environmental conditions. JEDEC No. TO-36 package; outline 14, Outlines Section.

**MAXIMUM RATINGS**

Collector-to-Base Voltage (with emitter-to-base volts = -1.5) ..	-40 max	volts
Emitter-to-Base Voltage (with collector open) .....	-20 max	volts
Collector Current .....	-15 max	amperes
Emitter Current .....	15 max	amperes
Base Current .....	-4 max	amperes
Transistor Dissipation:		
At case temperatures up to 25°C .....	150 max	watts
At case temperatures above 25°C .....	See curve	page 80
Case-Temperature Range:		
Operating and storage .....	-65 to 100	

**CHARACTERISTICS**

Collector-to-Emitter Breakdown Voltage:		
With base short-circuited to emitter and collector amperes = -0.3 .....	-40 min	volts
With base open and collector amperes = -0.3 .....	-40	volts
Base-to-Emitter Voltage (with collector-to-emitter volts = -2 and collector amperes = -5) .....	-0.65	volt
Emitter-to-Base Voltage (with collector-to-base volts = -40 and emitter current = 0) .....	-1 max	volt
Collector-to-Emitter Saturation Voltage (with collector amperes = -12 and base amperes = -2) .....	-0.3	volt
Collector-to-Emitter Reach-Through Voltage .....	-40 min	volts

Emitter-Cutoff Current (with emitter-to-base volts = -20 and collector current = 0) .....	-1	ma
Collector-Cutoff Current:		
With collector-to-base volts = -2 and emitter current = 0 .....	-100	$\mu$ a
With collector-to-base volts = -40 and emitter current = 0 .....	-2	ma
Thermal Resistance (junction-to-case) .....	0.35	$^{\circ}$ C/watt
Thermal Capacity (for pulse durations of 1 to 10 milliseconds) ..	0.075	watt-sec/ $^{\circ}$ C
Thermal Time Constant .....	26.25	msec

**In Common-Emitter Circuit**

DC Forward Current-Transfer Ratio:		
With collector-to-emitter volts = -2 and collector amperes = -5 .....	20 to 40	
With collector-to-emitter volts = -2 and collector amperes = -12 .....	20	
Small-Signal Forward-Current-Transfer-Ratio Cutoff Frequency (with collector-to-emitter volts = -6 and collector amperes = -5) .....	10	kc

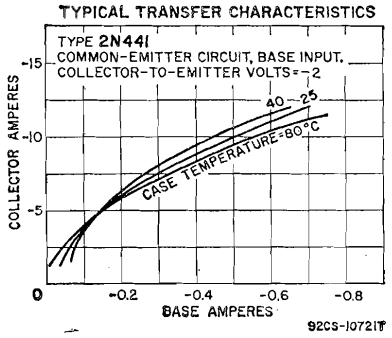
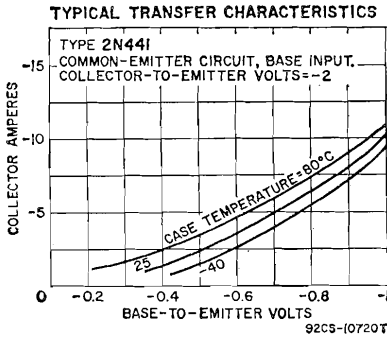

**TYPICAL OPERATION IN POWER-SWITCHING CIRCUIT**

DC Collector Supply Voltage .....	-12	volts
DC Base Supply Voltage .....	6	volts
On DC Collector Current .....	-12	amperes
Turn-On DC Base Current .....	-2	amperes
Turn-Off DC Base Current .....	0	amperes
Switching Time:		
Rise time .....	15	$\mu$ sec
Fall time .....	15	$\mu$ sec

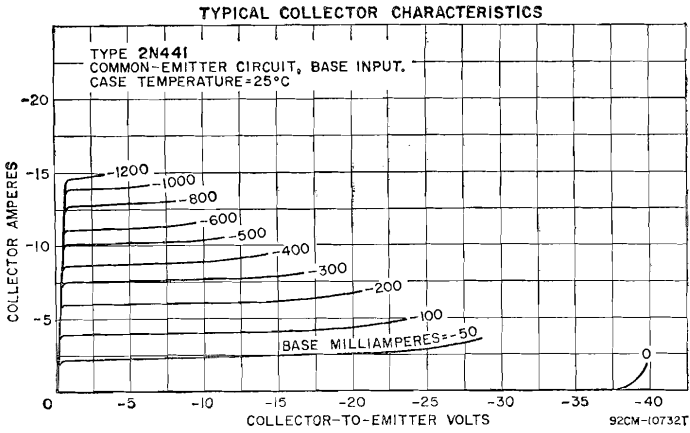

**POWER TRANSISTOR**

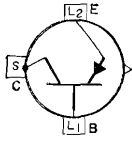

Germanium p-n-p type used in a wide variety of switching and amplifier applications in industrial and military equipment requiring transistors having high voltage, current, and dissipation values. It is used in

**2N442**

power-supply, voltage- and current-regulating, dc-to-dc converter, inverter, power-supply, and relay- and solenoid-actuating circuits; and in low-frequency oscillator and audio-amplifier service. This type is designed to provide satisfactory performance under extreme environmental conditions of temperature, moisture, and altitude; it is stud-mounted to provide positive heat-sink contact, and has a cold-weld seal to insure reliable performance under severe environmental conditions. JEDEC No. TO-36 package; outline 14, Outlines Section. This type is identical with type 2N441 except for the following items:

**MAXIMUM RATINGS**

Collector-to-Base Voltage (with emitter-to-base volts = -1.5) ..	-50 max	volts
Emitter-to-Base Voltage (with collector open) .....	-30 max	volts

**CHARACTERISTICS**

<b>Collector-to-Emitter Breakdown Voltage:</b>		
With base short-circuited to the emitter and collector amperes = -0.3 .....	-45 min	volts
With base open and collector amperes = -0.3 .....	-45	volts
Emitter-to-Base Voltage (with collector-to-base volts = -50 and emitter current = 0) .....	-1 max	volt
Collector-to-Emitter Reach-Through Voltage .....	-50 min	volts
Emitter-Cutoff Current (with emitter-to-base volts = -30 and collector current = 0) .....	-1	ma
Collector-Cutoff Current (with collector-to-base volts = -40 and emitter current = 0) .....	-2	ma

**TYPICAL COLLECTOR CHARACTERISTICS**

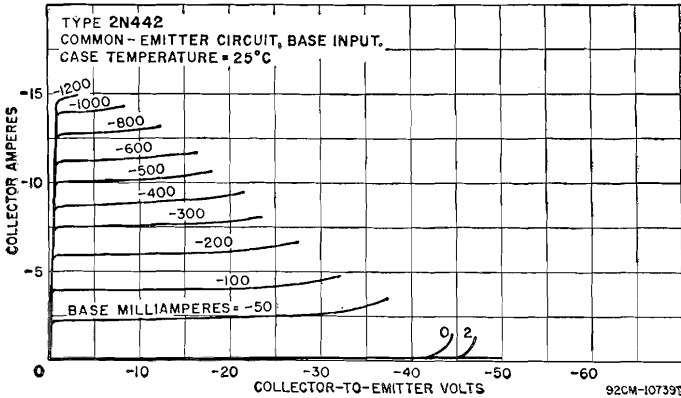

**POWER TRANSISTOR**

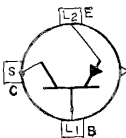

Germanium p-n-p type used in a wide variety of switching and amplifier applications in industrial and military equipment requiring transistors having high voltage, current, and dissipation values. It is used in

**2N443**

power-switching, voltage- and current-regulating, dc-to-dc converter, inverter,

power-supply, and relay- and solenoid-actuating circuits; and in low-frequency oscillator and audio-amplifier service. This type is designed to provide satisfactory performance under extreme environmental conditions of temperature, moisture, and altitude; it is stud-mounted to provide positive heat-sink contact, and has a cold-weld seal to insure reliable performance under severe environmental conditions. JEDEC No. TO-36 package; outline 14, Outlines Section. This type is identical with type 2N441 except for the following items:

**MAXIMUM RATINGS**

Collector-to-Base Voltage (with emitter-to-base volts = -1.5) ..	-60 max	volts
Emitter-to-Base Voltage (with collector open) .....	-40 max	volts

**CHARACTERISTICS**

Collector-to-Emitter Breakdown Voltage:		
With base short-circuited to the emitter and collector amperes = -0.3 .....	-50 min	volts
With base open and collector amperes = -0.3 .....	-55	volts
Emitter-to-Base Voltage (with collector-to-base volts = -60 and emitter current = 0) .....	-1 max	volt
Collector-to-Emitter Reach-Through Voltage .....	-60 min	volts
Emitter-Cutoff Current (with emitter-to-base volts = -40 and collector current = 0) .....	-1	ma
Collector-Cutoff Current (with collector-to-base volts = -60 and emitter current = 0) .....	-2	ma

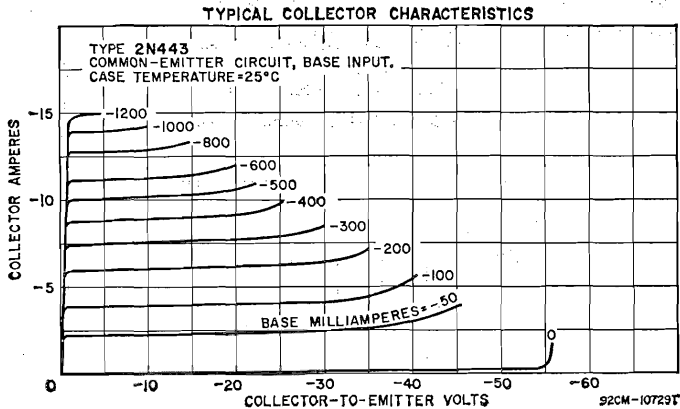

**2N456** See List of Discontinued Transistors at end of Technical Data Section for abbreviated data.

**2N457** See List of Discontinued Transistors at end of Technical Data Section for abbreviated data.

**2N497** See List of Discontinued Transistors at end of Technical Data Section for abbreviated data.

**2N544** See List of Discontinued Transistors at end of Technical Data Section for abbreviated data.

**2N561** See List of Discontinued Transistors at end of Technical Data Section for abbreviated data.

See List of Discontinued Transistors at end of Technical Data Section for abbreviated data.

**2N578**

See List of Discontinued Transistors at end of Technical Data Section for abbreviated data.

**2N579**

See List of Discontinued Transistors at end of Technical Data Section for abbreviated data.

**2N580**

**TRANSISTOR**

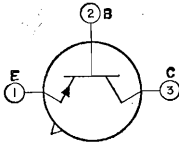

Germanium p-n-p type used in medium-speed switching applications in data-processing equipment. JEDEC No. TO-5 package; outline 6, Outlines Section. This type is identical with type 2N404 except for

**2N581**

the following items:

**MAXIMUM RATINGS**

Collector-to-Base Voltage (with emitter open)	-18 max	volts
Collector-to-Emitter Voltage (with emitter-to-base volts = -1)	-15 max	volts
Emitter-to-Base Voltage (with collector open)	-10 max	volts

**CHARACTERISTICS**

Collector-to-Emitter Saturation Voltage (with collector ma = -20 and base ma = -1)	-0.3	volt
Base-to-Emitter Saturation Voltage (with collector ma = -20 and base ma = -1)	-0.5 max	volt
Collector-Cutoff Current (with collector-to-base volts = -12 and emitter current = 0)	-10 max	μa
Stored Base Charge (with collector ma = -20 and base ma = -2)	2400 max	pcoul

*In Common-Emitter Circuit*

Forward Current-Transfer Ratio (with collector-to-emitter volts = -0.3 and collector ma = -20)	20 min
--	--------

**TRANSISTOR**

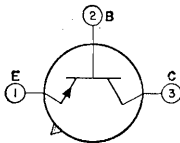

Germanium p-n-p type used in medium-speed switching applications in data-processing equipment. JEDEC No. TO-5 package; outline 6, Outlines Section. This type is identical with type 2N404 except for

**2N582**

the following items:

**MAXIMUM RATINGS**

Collector-to-Emitter Voltage (with emitter-to-base volts = -1)	-14 max	volts
--	---------	-------

**CHARACTERISTICS**

Collector-to-Emitter Saturation Voltage:		
With collector ma = -24 and base ma = -0.6	-0.2 max	volt
With collector ma = -100 and base ma = -5	-0.3 max	volt
Base-to-Emitter Saturation Voltage:		
With collector ma = -24 and base ma = -0.6	-0.4 max	volt
With collector ma = -100 and base ma = -5	-0.8 max	volt
Stored Base Charge (with collector ma = -24 and base ma = -1.2)	1200 max	pcoul

*In Common-Base Circuit*

Forward-Current-Transfer-Ratio Cutoff Frequency (with collector-to-base volts = -6 and collector ma = -1)	14 min	Mc
---	--------	----

*In Common-Emitter Circuit*

Forward Current-Transfer Ratio:  
 With collector-to-emitter volts = -0.2 and collector ma = -24 40 min  
 With collector-to-emitter volts = -0.3 and collector ma = -100 20 min

**2N583**

See List of Discontinued Transistors at end of Technical Data Section for abbreviated data.

**2N584**

See List of Discontinued Transistors at end of Technical Data Section for abbreviated data.

**TRANSISTOR**

**2N585**

Germanium n-p-n type used in switching circuits of compact, medium-speed electronic computers. JEDEC No. TO-5 package; outline 6, Outlines Section.

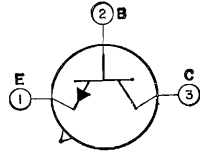

**MAXIMUM RATINGS**

Collector-to-Base Voltage (with emitter open) .....	25 max	volts
Collector-to-Emitter Voltage:		
With base open .....	15 max	volts
With base-to-emitter volts = -1 .....	24 max	volts
Emitter-to-Base Voltage (with collector open) .....	20 max	volts
Collector Current .....	200 max	ma
Transistor Dissipation:		
At ambient temperatures up to 25°C .....	120 max	mw
At ambient temperature of 55°C .....	35 max	mw
At ambient temperature of 71°C .....	10 max	mw
Ambient-Temperature Range:		
Operating .....	-65 to 71	°C
Storage .....	-65 to 85	°C

**CHARACTERISTICS**

Collector-to-Emitter Saturation Voltage (with collector ma = 20 and base ma = 1) .....	0.2 max	volt
Base-to-Emitter Saturation Voltage (with collector ma = 20 and base ma = 1) .....	0.45 max	volt
Collector-Cutoff Current:		
With collector-to-base volts = 0.25 and emitter current = 0 ..	6 max	µa
With collector-to-base volts = 12 and emitter current = 0 ..	8 max	µa
Stored Base Charge (with collector ma = 20 and base ma = 2) ..	3000 max	pcoul

*In Common-Base Circuit*

Forward-Current-Transfer-Ratio Cutoff Frequency (with collector-to-base volts = 6 and collector ma = 1) .....	3 min	Mc
Collector-to-Base Capacitance (with collector-to-base volts = 6 and emitter open) .....	25 max	pf

*In Common-Emitter Circuit*

Forward Current-Transfer Ratio (with collector-to-emitter volts = 0.2 and collector ma = 20) .....	20 min
--	--------

**TRANSISTOR**

**2N586**

Germanium p-n-p type used in low-speed switching applications in industrial and military equipment. It is used as a relay-actuating device and in voltage-regulator, multi-vibrator, dc-to-dc converter, and

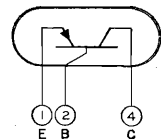

power-supply circuits. It can also be used in audio-frequency service as an

oscillator and in large-signal class A and class B circuits as a push-pull audio amplifier. Outline is similar to JEDEC No. TO-7 package; outline 25, Outlines Section.

**MAXIMUM RATINGS**

Collector-to-Base Voltage (with emitter open) .....	-45 max	volts
Emitter-to-Base Voltage (with collector open) .....	-12 max	volts
Collector Current .....	-250 max	ma
Emitter Current .....	250 max	ma
Transistor Dissipation:		
At ambient temperatures up to 25° .....	250 max	mw
At ambient temperatures above 25°C .....	See curve page 80	
Ambient-Temperature Range:		
Operating and storage .....	-65 to 85	°C

**CHARACTERISTICS**

Collector-to-Emitter Breakdown Voltage:		
With base short-circuited to emitter and collector $\mu a = -50$ ..	-70	volts
With base open and collector $ma = -1$ ..	-35	volts
Collector-to-Emitter Reach-Through Voltage		
(with emitter-to-base volts = -1 and emitter current = 0) ....	-75	volts
Base-to-Emitter Voltage		
(with collector $ma = -250$ and base $ma = -7$ ) .....	-0.7	volt
Collector-to-Emitter Saturation Voltage		
(with collector $ma = -250$ and base $ma = -25$ ) .....	-0.25	volt
Collector-Cutoff Current (with collector-to-base volts = -45		
and emitter current = 0) .....	-8	$\mu a$
Emitter-Cutoff Current (with emitter-to-base volts = -12		
and collector current = 0) .....	-4	$\mu a$

**In Common-Emitter Circuit**

DC Forward Current-Transfer Ratio (with collector-to-emitter volts = -0.5 and collector $ma = -250$ ) .....	55
---	----

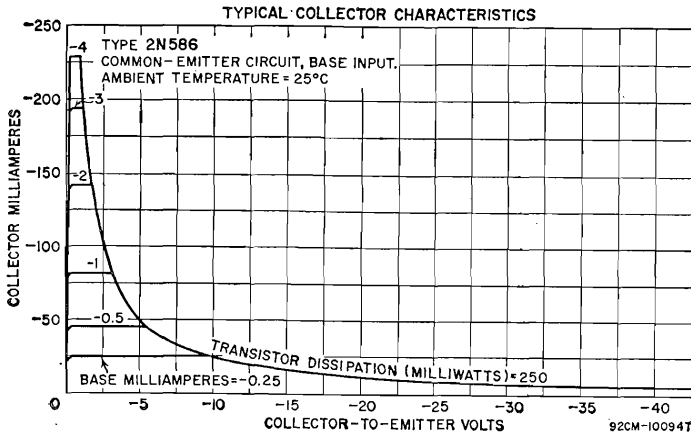
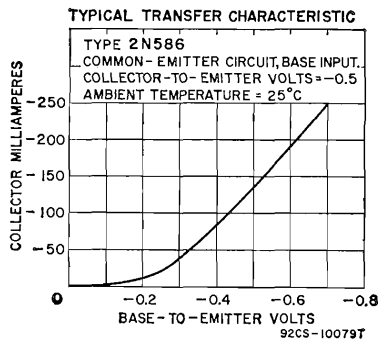
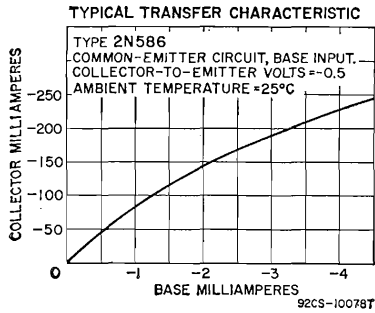

**TRANSISTOR**

**2N591**

Germanium p-n-p type used in large-signal audio-frequency driver-amplifier applications. It is used primarily in high-gain class A audio-driver stages in automobile radio receivers. JEDEC No. TO-1 package;

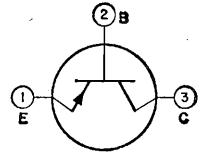

outline 4, Outlines Section.

**MAXIMUM RATINGS**

Collector-to-Emitter Voltage .....		-32 max	volts
Collector Current:			
Peak .....		-40 max	ma
DC .....		-20 max	ma
Emitter Current:			
Peak .....		40 max	ma
DC .....		20 max	ma
Collector Dissipation:			
At ambient temperatures up to 55°C .....	100	50	mw
At ambient temperature of 71°C .....	40	20	mw
Ambient-Temperature Range:			
Operating .....		71 max	°C
Storage .....		-65 to 85	°C

**CHARACTERISTICS**

Collector-to-Emitter Breakdown Voltage (with collector ma = -0.3, base resistance = 4700 ohms, and emitter resistance = 500 ohms) .....		-32 min	volts
Collector-Cutoff Current (with collector-to-base volts = -10 and emitter current = 0) .....		-7 max	µa
Emitter-Cutoff Current (with emitter-to-base volts = -1 and collector current = 0) .....		-20 max	µa
Thermal Resistance:			
Junction-to-ambient .....	0.34		°C/mw
Junction-to-heat sink .....	0.15		°C/mw

**In Common-Emitter Circuit**

DC Forward Current-Transfer Ratio at 1 kilocycle (with collector-to-emitter volts = -12 and collector ma = -2) .....	70	
Small-Signal Forward-Current-Transfer-Ratio Cutoff Frequency (with collector-to-emitter volts = -12 and collector ma = -2) .....	0.7	Mc

**TYPICAL OPERATION IN CLASS A AF DRIVER-AMPLIFIER CIRCUIT**

DC Collector Supply Voltage .....	-14.4	volts
DC Collector-to-Emitter Voltage .....	-12	volts
DC Base-to-Emitter Voltage .....	-0.13	volt
DC Collector Current .....	-2	ma
Signal Frequency .....	1	kc
Input Resistance .....	1000	ohms
Output Resistance .....	10000	ohms
Power Gain .....	41	db
Total Harmonic Distortion .....	3	per cent
Transistor Dissipation .....	25	mw
Power Output .....	5	mw

**2N640**

See List of Discontinued Transistors at end of Technical Data Section for abbreviated data.

**2N641**

See List of Discontinued Transistors at end of Technical Data Section for abbreviated data.

**2N642**

See List of Discontinued Transistors at end of Technical Data Section for abbreviated data.

**2N643**

See List of Discontinued Transistors at end of Technical Data Section for abbreviated data.



See List of Discontinued Transistors at end of Technical Data Section for abbreviated data.

**2N644**

See List of Discontinued Transistors at end of Technical Data Section for abbreviated data.

**2N645**

**TRANSISTOR**

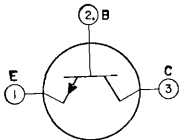

Germanium n-p-n type used in large-signal audio-frequency amplifier applications. It is designed especially for use with its p-n-p counterpart, RCA-2N217, in class B complementary-symmetry power-

**2N647**

output stages of compact transformerless, battery-operated portable radio receivers, phonographs, and audio amplifiers operating at battery-supply voltages up to 9 volts. This type can also be used in conventional class B push-pull and class A audio-amplifier circuits. JEDEC No. TO-1 package; outline 4, Outlines Section.

**MAXIMUM RATINGS**

Collector-to-Base Voltage (with emitter open) .....	25 max	volts
Collector-to-Emitter Voltage .....	25 max	volts
Emitter-to-Base Voltage (with collector open) .....	12 max	volts
Collector Current:		
Peak .....	100 max	ma
DC .....	50 max	ma
Emitter Current:		
Peak .....	-100 max	ma
DC .....	-50 max	ma
Collector Dissipation:		
At ambient temperatures up to 25°C .....	100 max	mw
At ambient temperature of 55°C .....	50 max	mw
At ambient temperature of 71°C .....	20 max	mw
Ambient Temperature:		
Operating .....	-65 to 71	°C
Storage .....	-65 to 85	°C

**CHARACTERISTICS**

Collector-Cutoff Current (with collector-to-base volts = 25 and emitter current = 0) .....	14 max	μa
Emitter-Cutoff Current (with emitter-to-base volts = 12 and collector current = 0) .....	14 max	μa

*In Common-Emitter Circuit*

DC Forward Current-Transfer Ratio (with collector-to-emitter volts = 1 and collector ma = 50) .....	70
---	----

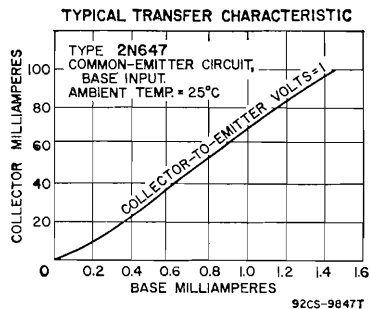
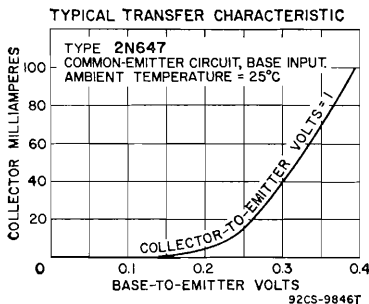

**TYPICAL OPERATION IN CLASS B COMPLEMENTARY-SYMMETRY CIRCUIT**

DC Collector Supply Voltage .....	6	volts
DC Collector-to-Emitter Voltage for driver stage .....	2.3	volts
Zero-Signal DC Base-to-Emitter Voltage for output stage .....	0.14	volt
Peak Collector Current for each transistor in output stage .....	70	ma
Zero-Signal DC Collector Current for each transistor (driver and output stage) .....	1.5	ma
Signal Frequency .....	1	kc
Input Resistance .....	1100	ohms
Load Resistance .....	45	ohms
Power Gain .....	54	db
Total Harmonic Distortion .....	10	max per cent
Power Output (with input = 20 millivolts) .....	100	mw

**TYPICAL COLLECTOR CHARACTERISTICS**

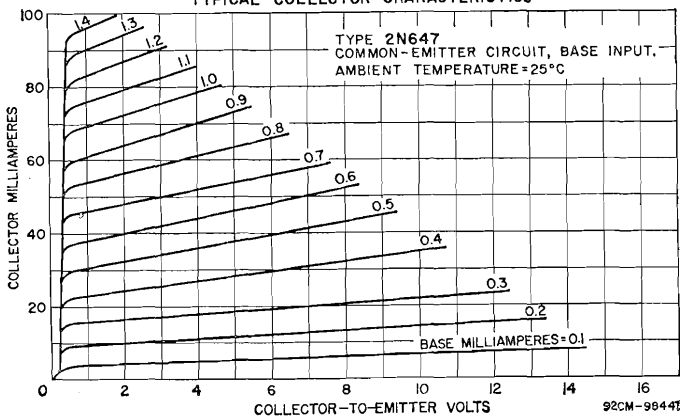

**TRANSISTOR**

**2N649**

Germanium n-p-n type used in large-signal audio-frequency amplifier applications. It is designed especially for use with its p-n-p counterpart, RCA-2N408, in class B complementary-symmetry power-

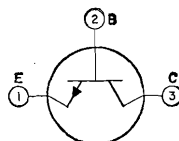

output stages of compact, transformerless, battery-operated portable radio receivers, phonographs, and audio amplifiers operating at battery-supply voltages up to 9 volts. This type can also be used in conventional class B push-pull and class A audio-amplifier circuits. JEDEC No. TO-1 package; outline 4, Outlines Section. This type is identical with type 2N647 except for the following items:

**MAXIMUM RATINGS**

Collector-to-Base Voltage (with emitter open) .....	20 max	volts
Collector-to-Emitter Voltage (with base open) .....	18 max	volts
Emitter-to-Base Voltage (with collector open) .....	2.5 max	volts

**CHARACTERISTICS**

Collector-Cutoff Current (with collector-to-base volts = 12 and emitter current = 0) .....	14 max	μa
Emitter-Cutoff Current (with emitter-to-base volts = 2.5 and collector current = 0) .....	14 max	μa

**In Common-Emitter Circuit**

DC Forward Current-Transfer Ratio (with collector-to-emitter volts = 1 and collector ma = 50) .....	65
---	----

**2N656**

See List of Discontinued Transistors at end of Technical Data Section for abbreviated data.

### SILICON CONTROLLED RECTIFIER

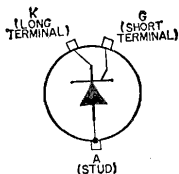

Diffused-junction n-p-n-p type used in a wide variety of power-control and power-switching applications in industrial and military equipment. This type has a maximum peak forward blocking voltage

# 2N681

of 25 volts and a forward-current capability of 16 amperes (average value) or 25 amperes (rms value). This type is designed to meet stringent military environmental and mechanical specifications. The special high-strength copper-alloy stud can withstand an installing torque up to 50 inch-pounds. JEDEC No. TO-48 package; outline 19, Outlines Section.

#### MAXIMUM RATINGS

For sinusoidal ac supply voltage of 50 to 400 cps, with resistive or inductive load

Peak Reverse Voltage:		
Repetitive	25 max	volts
Non-repetitive (transient)	35 max	volts
Peak Forward Blocking Voltage (repetitive)	25 max	volts
Peak Gate Voltage:		
Forward	10 max	volts
Reverse	5 max	volts
Average Forward Current:		
At case temperature of 65°C and conduction angle of 180°	16 max	amperes
For other case temperatures and conduction angles	See Rating Chart I	
Peak Surge Current:		
For one cycle of applied voltage	150 max	amperes
For more than one cycle of applied voltage	See Rating Chart II	
Peak Forward Gate Current	2 max	amperes
Peak Gate Power	5 max	watts
Average Gate Power	0.5 max	watt
Temperature Range:		
Operating (case)	-65 to 125	°C
Operating (ambient)	See Rating Chart III	
Storage	-65 to 150	°C

#### CHARACTERISTICS

Forward Breakover Voltage (at case temperature of 125°C)	25 min	volts
Forward Voltage Drop (at case temperature of 65°C)	0.86 max	volt
DC Gate-Trigger Voltage:		
At case temperature of -65°C	3 max	volts
At case temperature of 125°C	0.25 min	volt
Average Blocking Current (at case temperature of 125°C):		
Forward	6.5 max	ma
Reverse	6.5 max	ma
DC Gate-Trigger Current (at case temperature of 125°C)	25 max	ma
Holding Current (at case temperature of 125°C)	5	ma
Thermal Resistance (junction-to-case)	2 max	°C/watt

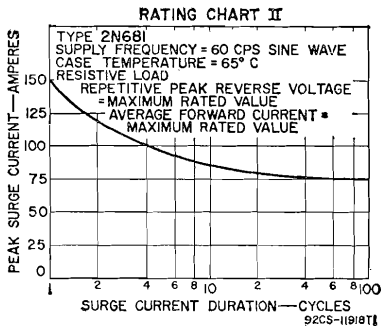
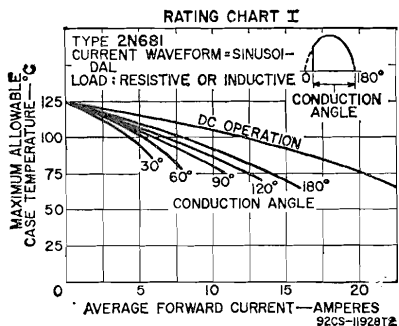

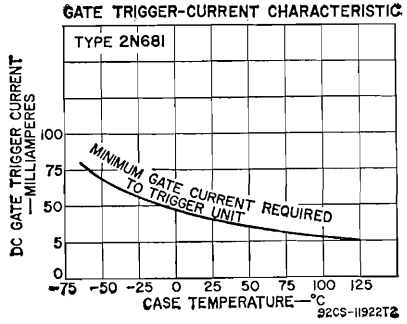
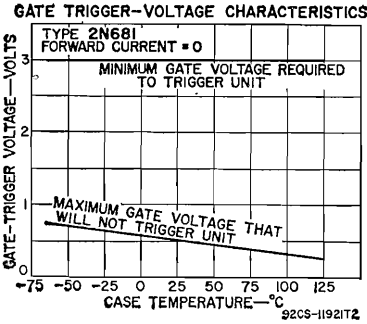
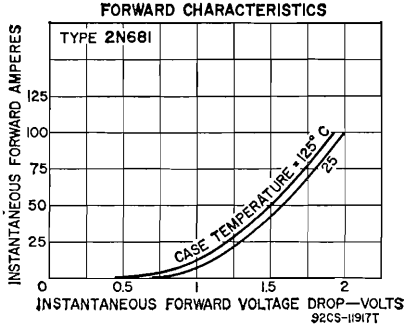
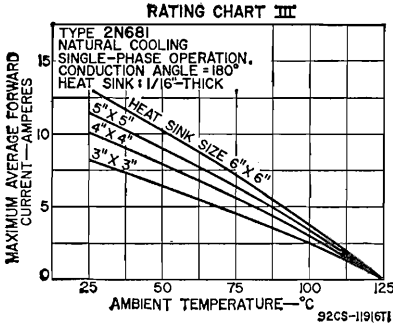

**SILICON CONTROLLED RECTIFIER**

**2N682**

Diffused-junction n-p-n-p type used in a wide variety of power-control and power switching applications in industrial and military equipment. This type has a maximum peak forward blocking voltage

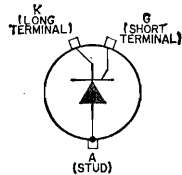

of 50 volts and a forward-current capability of 16 amperes (average value) or 25 amperes (rms value). This type is designed to meet stringent military environmental and mechanical specifications. The special high-strength copper-alloy stud can withstand an installing torque up to 50 inch-pounds. JEDEC No. TO-48 package; outline 19, Outlines Section. This type is identical with type 2N681 except for the following items:

**MAXIMUM RATINGS**

*For sinusoidal ac supply voltage of 50 to 400 cps, with resistive or inductive load*

Peak Reverse Voltage:		
Repetitive .....	50 max	volts
Non-repetitive (transient) .....	75 max	volts
Peak Forward Blocking Voltage (repetitive) .....	50 max	volts

**CHARACTERISTICS**

Forward Breakover Voltage (at case temperature of 125°C) ....	50 min	volts
---	--------	-------

**SILICON CONTROLLED RECTIFIER**

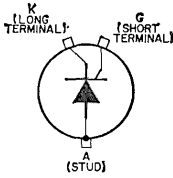

**2N683**

Diffused-junction n-p-n-p type used in a wide variety of power-control and power switching applications in industrial and military equipment. This type has a maximum peak forward blocking voltage of 100 volts and a forward-current capability of 16 amperes (average value) or 25 amperes (rms value). This type is designed to meet stringent military environmental and mechanical specifications. The special high-strength copper-alloy stud can withstand an installing torque up to 50 inch-pounds. JEDEC No. TO-48 package; outline 19, Outlines Section. This type is identical with type 2N681 except for the following items:

**MAXIMUM RATINGS**

*For sinusoidal ac supply voltage of 50 to 400 cps, with resistive or inductive load*

Peak Reverse Voltage:			
Repetitive .....	100 max	volts	
Non-repetitive (transient) .....	150 max	volts	
Peak Forward Blocking Voltage (repetitive) .....	100 max	volts	

**CHARACTERISTICS**

Forward Breakover Voltage (at case temperature of 125°C) ....	100 min	volts
---	---------	-------

**SILICON CONTROLLED RECTIFIER**

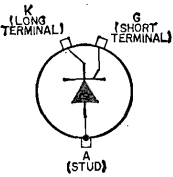

**2N684**

Diffused-junction n-p-n-p type used in a wide variety of power-control and power switching applications in industrial and military equipment. This type has a maximum peak forward blocking voltage of 150 volts and a forward-current capability of 16 amperes (average value) or 25 amperes (rms value). This type is designed to meet stringent military environmental and mechanical specifications. The special high-strength copper-alloy stud can withstand an installing torque up to 50 inch-pounds. JEDEC No. TO-48 package; outline 19, Outlines Section. This type is identical with type 2N681 except for the following items:

**MAXIMUM RATINGS**

*For sinusoidal ac supply voltage of 50 to 400 cps, with resistive or inductive load*

Peak Reverse Voltage:			
Repetitive .....	150 max	volts	
Non-repetitive (transient) .....	225 max	volts	
Peak Forward Blocking Voltage (repetitive) .....	150 max	volts	

**CHARACTERISTICS**

Forward Breakover Voltage (at case temperature of 125°C) ....	150 min	volts
---	---------	-------

**SILICON CONTROLLED RECTIFIER**

**2N685**

Diffused-junction n-p-n-p type used in a wide variety of power-control and power switching applications in industrial and military equipment. This type has a maximum peak forward blocking voltage

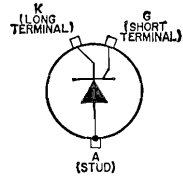

of 200 volts and a forward-current capability of 16 amperes (average value) or 25 amperes (rms value). This type is designed to meet stringent military environmental and mechanical specifications. The special high-strength copper-alloy stud can withstand an installing torque up to 50 inch-pounds. JEDEC No. TO-48 package; outline 19, Outlines Section. This type is identical with type 2N681 except for the following items:

**MAXIMUM RATINGS**

*For sinusoidal ac supply voltage of 50 to 400 cps, with resistive or inductive load*

Peak Reverse Voltage:		
Repetitive .....	200 max	volts
Non-repetitive (transient) .....	300 max	volts
Peak Forward Blocking Voltage (repetitive) .....	200 max	volts

**CHARACTERISTICS**

Forward Breakover Voltage (at case temperature of 125°C) ....	200 min	volts
Average Blocking Current (at case temperature of 125°C):		
Forward .....	6 max	ma
Reverse .....	6 max	ma

**SILICON CONTROLLED RECTIFIER**

**2N686**

Diffused-junction n-p-n-p type used in a wide variety of power-control and power switching applications in industrial and military equipment. This type has a maximum peak forward blocking voltage

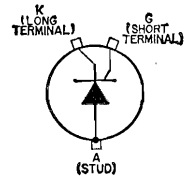

of 250 volts and a forward-current capability of 16 amperes (average value) or 25 amperes (rms value). This type is designed to meet stringent military environmental and mechanical specifications. The special high-strength copper-alloy stud can withstand an installing torque up to 50 inch-pounds. JEDEC No. TO-48 package; outline 19, Outlines Section. This type is identical with type 2N681 except for the following items:

**MAXIMUM RATINGS**

*For sinusoidal ac supply voltage of 50 to 400 cps, with resistive or inductive load*

Peak Reverse Voltage:		
Repetitive .....	250 max	volts
Non-repetitive (transient) .....	350 max	volts
Peak Forward Blocking Voltage (repetitive) .....	250 max	volts

**CHARACTERISTICS**

Forward Breakover Voltage (at case temperature of 125°C) ....	250 min	volts
Average Blocking Current (at case temperature of 125°C):		
Forward .....	5.5 max	ma
Reverse .....	5.5 max	ma

**SILICON CONTROLLED RECTIFIER**

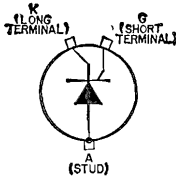

**2N687**

Diffused-junction n-p-n-p type used in a wide variety of power-control and power switching applications in industrial and military equipment. This type has a maximum peak forward blocking voltage of 300 volts and a forward-current capability of 16 amperes (average value) or 25 amperes (rms value). This type is designed to meet stringent military environmental and mechanical specifications. The special high-strength copper-alloy stud can withstand an installing torque up to 50 inch-pounds. JEDEC No. TO-48 package; outline 19, Outlines Section. This type is identical with type 2N681 except for the following items:

**MAXIMUM RATINGS**

*For sinusoidal ac supply voltage of 50 to 400 cps, with resistive or inductive load*

Peak Reverse Voltage:		
Repetitive .....	300 max	volts
Non-repetitive (transient) .....	400 max	volts
Peak Forward Blocking Voltage (repetitive) .....	300 max	volts

**CHARACTERISTICS**

Forward Breakover Voltage (at case temperature of 125°C) ....	300 min	volts
Average Blocking Current (at case temperature of 125°C):		
Forward .....	5 max	ma
Reverse .....	5 max	ma

**SILICON CONTROLLED RECTIFIER**

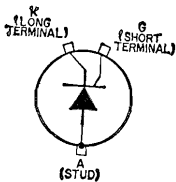

**2N688**

Diffused-junction n-p-n-p type used in a wide variety of power-control and power switching applications in industrial and military equipment. This type has a maximum peak forward blocking voltage of 400 volts and a forward-current capability of 16 amperes (average value) or 25 amperes (rms value). This type is designed to meet stringent military environmental and mechanical specifications. The special high-strength copper-alloy stud can withstand an installing torque up to 50 inch-pounds. JEDEC No. TO-48 package; outline 19, Outlines Section. This type is identical with type 2N681 except for the following items:

**MAXIMUM RATINGS**

*For sinusoidal ac supply voltage of 50 to 400 cps, with resistive or inductive load*

Peak Reverse Voltage:		
Repetitive .....	400 max	volts
Non-repetitive (transient) .....	500 max	volts
Peak Forward Blocking Voltage (repetitive) .....	400 max	volts

**CHARACTERISTICS**

Forward Breakover Voltage (at case temperature of 125°C) ....	400 min	volts
Average Blocking Current (at case temperature of 125°C):		
Forward .....	4 max	ma
Reverse .....	4 max	ma

### SILICON CONTROLLED RECTIFIER

## 2N689

Diffused-junction n-p-n-p type used in a wide variety of power-control and power switching applications in industrial and military equipment. This type has a maximum peak forward blocking voltage

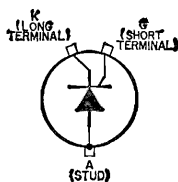

of 500 volts and a forward-current capability of 16 amperes (average value) or 25 amperes (rms value). This type is designed to meet stringent military environmental and mechanical specifications. The special high-strength copper-alloy stud can withstand an installing torque up to 50 inch-pounds. JEDEC No. TO-48 package; outline 19, Outlines Section. This type is identical with type 2N681 except for the following items:

#### MAXIMUM RATINGS

*For sinusoidal ac supply voltage of 50 to 400 cps, with resistive or inductive load*

Peak Reverse Voltage:		
Repetitive .....	500 max	volts
Non-repetitive (transient) .....	600 max	volts
Peak Forward Blocking Voltage (repetitive) .....	500 max	volts

#### CHARACTERISTICS

Forward Breakover Voltage (at case temperature of 125°C) ....	500 min	volts
Average Blocking Current (at case temperature of 125°C):		
Forward .....	3 max	ma
Reverse .....	3 max	ma

## 2N696

See List of Discontinued Transistors at end of Technical Data Section for abbreviated data.

### TRANSISTOR

## 2N697

Silicon n-p-n type used in high-speed switching applications in data-processing equipment. This type is especially effective under conditions of severe thermal and mechanical stress and other environmental haz-

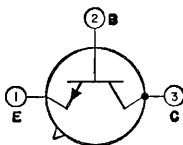

ards. JEDEC No. TO-5 package; outline 6, Outlines Section.

#### MAXIMUM RATINGS

Collector-to-Base Voltage (with emitter open) .....	60 max	volts
Collector-to-Emitter Voltage (with external base-to-emitter resistance = 10 ohms or less) .....	40 max	volts
Emitter-to-Base Voltage (with collector open) .....	5 max	volts
Collector Current .....	500 max	ma
Transistor Dissipation:		
At case temperatures up to 25°C .....	2 max	watts
At ambient temperatures up to 25°C .....	0.6 max	watt
At case or ambient temperatures above 25°C .....	See curve	page 80
Temperature Range:		
Operating (junction) and Storage .....	-65 to 175	°C
Lead Temperature (for 10 seconds maximum) .....	255 max	°C

#### CHARACTERISTICS

Base-to-Emitter Saturation Voltage (with pulsed collector ma = 150* and base ma = 15) .....	1.3 max	volts
Collector-to-Emitter Saturation Voltage (with pulsed collector ma = 150* and base ma = 15) .....	1.5 max	volts
Collector-Cutoff Current (with collector-to-base volts = 30 and emitter current = 0) .....	1 max	µa



**In Common-Base Circuit**

Collector-to-Base Capacitance (with collector-to-base volts = 10 and emitter current = 0) .....	35 max	pf
---	--------	----

**In Common-Emitter Circuit**

DC-Pulse Forward Current-Transfer Ratio (with collector-to-emitter volts = 10 and collector ma = 150**) .....	40 to 120	
Small-Signal Forward Current-Transfer Ratio (with collector-to-emitter volts = 10, collector ma = 50, and frequency = 20 Mc) .....		2.5 min
Gain-Bandwidth Product .....		100

\* Pulse duration = 300  $\mu$ sec or less; duty cycle = 0.02 or less.  
 \*\* Pulse duration = 12 milliseconds or less; duty cycle = 0.02 or less.

**TRANSISTOR**

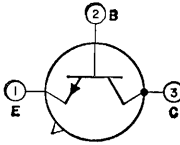

Silicon n-p-n type used in a wide variety of small-signal and medium-power applications in industrial and military equipment. It can be used in rf service as an amplifier, mixer, oscillator, and con-

**2N699**

verter; in af service for small-signal and power applications; in switching service for high-speed switching circuits. It features low saturation voltage, high sustaining voltage, and low output capacitance. JEDEC No. TO-5 package; outline 6, Outlines Section. For curves of collector characteristics, refer to type 2N1613.

**MAXIMUM RATINGS**

Collector-to-Base Voltage (with emitter open) .....	120 max	volts
Collector-to-Emitter Voltage (with external base-to-emitter resistance of 10 ohms or less) .....	80 max	volts
Emitter-to-Base Voltage (with collector open) .....	5 max	volts
Transistor Dissipation:		
At case temperatures up to 25°C .....	2 max	watts
At ambient temperatures up to 25°C .....	0.6 max	watt
At case or ambient temperatures above 25°C .....	See curve	page 80
Temperature Range:		
Operating (junction) .....	-65 to 175	°C
Storage .....	-65 to 300	°C

**CHARACTERISTICS**

Collector-to-Base Breakdown Voltage (with collector ma = 0.1 and emitter current = 0) .....	120 min	volts
Collector-to-Emitter Sustaining Voltage (with external base-to-emitter resistance = 10 ohms or less and collector ma = 100) .....	80 min	volts
Base-to-Emitter Saturation Voltage (with pulsed collector ma = 150* and emitter ma = 15) .....	1.3 max	volts
Collector-to-Emitter Saturation Voltage (with pulsed collector ma = 150* and emitter ma = 15) .....	5 max	volts
Collector-Cutoff Current (with collector-to-base volts = 60 and emitter current = 0) .....	2 max	$\mu$ a
Emitter-Cutoff Current (with emitter-to-base volts = 2 and collector current = 0) .....	100 max	$\mu$ a
Thermal Resistance:		
Junction-to-case .....	75 max	°C/watt
Junction-to-ambient .....	250 max	°C/watt

**In Common-Base Circuit**

Input Resistance at 1 kilocycle:		
With collector-to-base volts = 5 and collector ma = 1 .....	20 to 30	ohms
With collector-to-base volts = 10 and collector ma = 5 .....	10 max	ohms
Output Capacitance (with collector-to-base volts = 10 and emitter ma = 0) .....	20 max	pf
Output Conductance at 1 kilocycle:		
With collector-to-base volts = 5 and collector ma = 1 .....	0.1 to 0.5	$\mu$ mho
With collector-to-base volts = 10 and collector ma = 5 .....	1 max	$\mu$ mho
Small-Signal Open-Circuit Reverse Voltage-Transfer Ratio at 1 kilocycle:		
With collector-to-base volts = 5 and collector ma = 1 .....	0.00025 max	
With collector-to-base volts = 10 and collector ma = 5 .....	0.0003 max	

**In Common-Emitter Circuit**

DC-Pulse Forward Current-Transfer Ratio (with collector-to-emitter volts = 10 and collector ma = 150*)	40 to 120
Small-Signal Forward Current-Transfer Ratio:	
With collector-to-emitter volts = 5, collector ma = 1, and frequency = 1 kilocycle	35 to 100
With collector-to-emitter volts = 10, collector ma = 5, and frequency = 1 kilocycle	45 min
With collector-to-emitter volts = 10, collector ma = 50, and frequency = 20 Mc	2.5 min

\* Pulse duration = 300 μsec or less; duty cycle = 0.02 or less.

**TRANSISTOR**

**2N705**

Germanium p-n-p type used in high-speed logic-circuit applications in data-processing equipment. JEDEC No. TO-18 package; outline 12, Outlines Section.

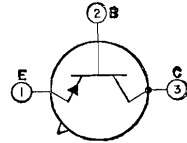

**MAXIMUM RATINGS**

Collector-to-Base Voltage (with emitter open)	-15 max	volts
Collector-to-Emitter Voltage (with external base-to-emitter resistance = 10 ohms or less)	-15 max	volts
Emitter-to-Base Voltage (with collector open)	-3.5 max	volts
Collector Current	-50 max	ma
Emitter Current	50 max	ma
Transistor Dissipation:		
At ambient temperatures up to 25°C	150 max	mw
At case temperatures up to 25°C	300 max	mw
At ambient or case temperatures above 25°C	See curve page 80	
Temperature Range:		
Operating (junction) and storage	-65 to 100	°C
Lead Temperature (for 10 seconds maximum)	230 max	°C

**CHARACTERISTICS**

Base-to-Emitter Voltage (with collector ma = -10 and base ma = -0.4)	-0.44 max	volt
Collector-to-Emitter Saturation Voltage (with collector ma = -10 and base ma = -0.4)	-0.3 max	volt
Collector-Cutoff Current (with collector-to-base volts = -5 and emitter current = 0)	-3 max	μa
Collector Transition Capacitance (with collector-to-base volts = -10, emitter current = 0, and frequency = 1 Mc)	5	pf
Emitter Transition Capacitance (with emitter-to-base volts = -2, collector current = 0, and frequency = 1 Mc)	3.5	pf

**In Common-Emitter Circuit**

Small-Signal Forward Current-Transfer Ratio (with collector-to-emitter volts = -5, collector ma = -10, and frequency = 100 Mc)	3
DC Forward Current-Transfer Ratio (with collector-to-emitter volts = -0.3 and collector ma = -10)	25 min

**TRANSISTOR**

**2N706**  
**2N706A**

Silicon n-p-n type used in high-speed switching applications in data-processing equipment. JEDEC No. TO-18 package; outline 12, Outlines Section.

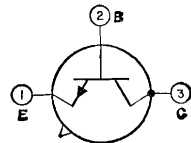

**MAXIMUM RATINGS**

Collector-to-Base Voltage (with emitter open)	2N706 25 max	2N706A 25 max	volts
Collector-to-Emitter Voltage (with external base-to-emitter resistance = 10 ohms)	20 max	20 max	volts
Emitter-to-Base Voltage (with collector open)	3 max	5 max	volts
Collector Current	-	50 max	ma
Transistor Dissipation:			
At ambient temperatures up to 25°C	0.3 max	0.3 max	watt
At ambient temperatures above 25°C	See curve page 80		
At case temperatures up to 25°C	1 max	1 max	watt
At case temperature of 100°C	0.5 max	1 max	watt

Temperature Range:			
Operating (junction) and storage .....	-65 to 175		°C

**CHARACTERISTICS**

Base-to-Emitter Saturation Voltage (with collector ma = 10 and base ma = 1) ..	0.9 max	0.9 max	volt
Collector-to-Emitter Saturation Voltage (with collector ma = 10 and base ma = 1) ..	0.6 max	0.6 max	volt
Collector-Cutoff Current (with collector-to-base volts = 15 and emitter current = 0) .....	0.5 max	0.5 max	μa

*In Common-Base Circuit*

Collector-to-Base Capacitance (with collector- to-base volts = 10 and emitter current = 0) .	6 max	-	pf
---	-------	---	----

*In Common-Emitter Circuit*

DC-Pulse Forward Current-Transfer Ratio (with dc collector-to-emitter volts = 1, collector ma = 10, pulse duration = 12 milliseconds or less, and duty factor = 0.02 or less) .....	2N706	2N706A	
Small-Signal Forward Current-Transfer Ratio:	20 min	20 min	
With collector-to-emitter volts = 15, collector ma = 10, and frequency = 100 Mc	2 min	-	
With collector-to-emitter volts = 10, collector ma = 10, and frequency = 100 Mc	-	2 min	

**TRANSISTOR**

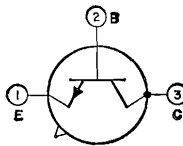

Silicon n-p-n type used in very-high-speed switching and high-frequency applications in equipment which requires high reliability and high packaging densities. JEDEC No. TO-18 package; outline 12, Outlines Section.

**2N708**

**MAXIMUM RATINGS**

Collector-to-Base Voltage (with emitter open) .....	40 max	volts
Collector-to-Emitter Voltage:		
With external base-to-emitter resistance = 10 ohms or less ..	20 max	volts
With base open .....	15 max	volts
Emitter-to-Base Voltage (with collector open) .....	5 max	volts
Transistor Dissipation:		
At case temperatures up to 25°C .....	1.2 max	watts
At ambient temperatures up to 25°C .....	0.36 max	watt
At case or ambient temperatures above 25°C .....	See curve page 80	
Temperature Range:		
Operating (junction) .....	-65 to 200	°C
Storage .....	-65 to 300	°C
Lead Temperature (for 10 seconds maximum) .....	300 max	°C

**CHARACTERISTICS**

Base-to-Emitter Saturation Voltage (with collector ma = 10 and base ma = 1) .....	0.8 max	volt
Collector-to-Emitter Saturation Voltage (with collector ma = 10 and base ma = 1) .....	0.4 max	volt
Collector-Cutoff Current (with collector-to-base volts = 20 and emitter ma = 0) .....	0.025 max	μa

*In Common-Base Circuit*

Collector-to-Base Capacitance (with collector-to-base volts = 10 and emitter current = 0) .....	6 max	pf
--	-------	----

*In Common-Emitter Circuit*

Small-Signal Forward Current-Transfer Ratio (with collector- to-emitter volts = 10, collector ma = 10, and frequency = 100 Mc) .....	3 min	
DC Forward Current-Transfer Ratio:		
With collector-to-emitter volts = 1 and collector ma = 10 ....	30 to 120	
With collector-to-emitter volts = 1 and collector ma = 0.5 ...	15 min	

**TRANSISTOR**

**2N709**

Silicon n-p-n type used in ultra-high-speed logic-circuit applications in data-processing equipment. JEDEC No. TO-18 package; outline 12, Outlines Section. This type is electrically identical with type

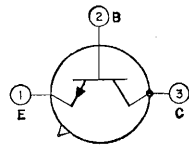

2N2475 except for the following items:

**CHARACTERISTICS**

Base-to-Emitter Saturation Voltage (with collector $i_a = 3$ and base $i_a = 0.15$ )	0.7 to 0.85	volt
Collector-to-Emitter Saturation Voltage (with collector $i_a = 3$ and base $i_a = 0.15$ )	0.3 max	volt

*In Common-Base Circuit*

Input Capacitance (with emitter-to-base volts = 0.5, collector current = 0, and frequency = 140 kilocycles)	2 max	pf
---	-------	----

*In Common-Emitter Circuit*

Small-Signal Forward Current-Transfer Ratio (with collector-to-emitter volts = 4, collector $i_a = 5$ , and frequency = 100 Mc)	6 min
DC Forward Current-Transfer Ratio: With collector-to-emitter volts = 1 and collector $i_a = 30$	15 min
With collector-to-emitter volts = 0.5 and collector $i_a = 10$	20 to 120

**TRANSISTOR**

**2N710**

Germanium p-n-p type used in high-speed logic-circuit applications in data-processing equipment. JEDEC No. TO-18 package; outline 12, Outlines Section. This type is identical with type 2N705 except for

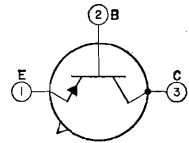

the following items:

**MAXIMUM RATINGS**

Emitter-to-Base Voltage (with collector open)	-2 max	volts
---	--------	-------

**CHARACTERISTICS**

Base-to-Emitter Voltage (with collector $i_a = -10$ and base $i_a = -0.4$ )	-0.5 max	volt
Collector-to-Emitter Saturation Voltage (with collector $i_a = -10$ and base $i_a = -0.4$ )	-0.5 max	volt

*In Common-Emitter Circuit*

Forward Current-Transfer Ratio (with collector-to-emitter volts = -0.5 and collector $i_a = -10$ )	25 min
--	--------

**TRANSISTOR**

**2N711**

Germanium p-n-p type used in high-speed logic-circuit applications in data-processing equipment. JEDEC No. TO-18 package; outline 12, Outlines Section. This type is identical with type 2N705 except

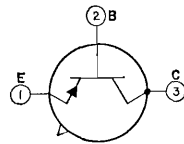

for the following items:

**MAXIMUM RATINGS**

Collector-to-Base Voltage (with emitter open)	-12 max	volts
Collector-to-Emitter Voltage (with external base-to-emitter resistance = 10 ohms or less)	-12 max	volts

Emitter-to-Base Voltage (with collector open) .....	-1 max	volt
Collector Current .....	-100 max	ma
Emitter Current .....	100 max	ma

**CHARACTERISTICS**

Base-to-Emitter Voltage (with collector ma = -10 and base ma = -0.5) .....	-0.5 max	volt
Collector-to-Emitter Saturation Voltage (with collector ma = -10 and base ma = -0.5) .....	-0.5 max	volt

*In Common-Emitter Circuit*

Small-Signal Forward Current-Transfer Ratio (with collector-to-emitter volts = -5, collector ma = -10, and frequency = 100 Mc) .....	2	
DC Forward Current-Transfer Ratio (with collector-to-emitter volts = -0.5 and collector ma = -10) .....	20 min	

**TRANSISTOR**

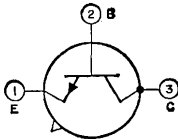

Silicon n-p-n type used in a wide variety of small-signal and high-speed switching applications. JEDEC No. TO-18 package; outline 12, Outlines Section.

**2N718A**

**MAXIMUM RATINGS**

Collector-to-Base Voltage (with emitter open) .....	75 max	volts
Collector-to-Emitter Voltage (with base open) .....	32 max	volts
Collector-to-Emitter Voltage (with external base-to-emitter resistance = 10 ohms or less) .....	50 max	volts
Emitter-to-Base Voltage (with collector open) .....	7 max	volts
Transistor Dissipation:		
At case temperatures up to 25°C .....	1.8 max	watts
At ambient temperatures up to 25°C .....	0.5 max	watt
At case or ambient temperatures above 25°C .....	See curve	page 80
Temperature Range:		
Operating (junction) .....	-65 to 200	°C
Storage .....	-65 to 300	°C
Lead Temperature (for 10 seconds maximum) .....	255 max	°C

**CHARACTERISTICS**

Collector-to-Base Breakdown Voltage (with collector ma = 0.1 and emitter current = 0) .....	75 min	volts
Emitter-to-Base Breakdown Voltage (with emitter ma = 0.1 and collector current = 0) .....	7 min	volts
Collector-to-Emitter Sustaining Voltage (with external base-to-emitter resistance = 10 ohms and pulsed collector ma = 100*) .....	50 min	volts
Base-to-Emitter Saturation Voltage (with pulsed collector ma = 150* and pulsed base ma = 15*) .....	1.3 max	volts
Collector-to-Emitter Saturation Voltage (with pulsed collector ma = 150* and pulsed base ma = 15*) .....	1.5 max	volts
Collector-Cutoff Current (with collector-to-base volts = 60 and emitter current = 0) .....	0.01 max	μa
Emitter-Cutoff Current (with emitter-to-base volts = 5 and collector current = 0) .....	0.01 max	μa
Thermal Resistance:		
Junction-to-case .....	97 max	°C/watt
Junction-to-ambient .....	350 max	°C/watt

*In Common-Base Circuit*

Emitter-to-Base Capacitance (with emitter-to-base volts = 0.5 and collector current = 0) .....	80 max	pf
Collector-to-Base Capacitance (with collector-to-base volts = 10 and emitter current = 0) .....	25 max	pf

*In Common-Emitter Circuit*

DC Forward Current-Transfer Ratio:		
With collector-to-emitter volts = 10 and pulsed collector ma = 150* .....	40 to 120	
With collector-to-emitter volts = 10 and pulsed collector ma = 500* .....	20 min	
With collector-to-emitter volts = 10 and pulsed collector ma = 10* .....	35 min	
With collector-to-emitter volts = 10 and collector ma = 0.1 .....	20 min	
With ambient temperature = -55°C, collector-to-emitter volts = 10, and pulsed collector ma = 10* .....	20 min	

Small-Signal Forward Current-Transfer Ratio:

With collector-to-emitter volts = 5, collector ma = 1, and frequency = 1 kilocycle .....	30 to 100
With collector-to-emitter volts = 10, collector ma = 5, and frequency = 1 kilocycle .....	35 to 150
With collector-to-emitter volts = 10, collector ma = 50, and frequency = 20 Mc .....	3 min

Small-Signal Open-Circuit Reverse Voltage-Transfer Ratio at 1 kilocycle:

With collector-to-emitter volts = 5 and collector ma = 1 ...	$3 \times 10^{-4}$ max
With collector-to-emitter volts = 10 and collector ma = 5 ...	$3 \times 10^{-4}$ max

Input Resistance at 1 kilocycle:

With collector-to-emitter volts = 5 and collector ma = 1 ...	24 to 34	ohms
With collector-to-emitter volts = 10 and collector ma = 5 ...	4 to 8	ohms

Output Conductance at 1 kilocycle:

With collector-to-emitter volts = 5 and collector ma = 1 ...	0.1 to 0.5	$\mu$ mho
With collector-to-emitter volts = 10 and collector ma = 5 ...	0.1 to 1	$\mu$ mho

Noise Figure (with collector-to-emitter volts = 10, collector ma = 0.3, generator resistance = 510 ohms, circuit bandwidth = 1 cps, and signal frequency = 1 kilocycle) .....

12 max db

Total Switching Time\*\* (delay time plus rise time plus fall time) .....

30 max nsec

\* Pulse duration = 300  $\mu$ sec; duty factor = 0.02 or less.

\*\* Refer to type 2N2102 for Total-Switching-Time Measurement Circuit.

31

TYPICAL COLLECTOR CHARACTERISTICS

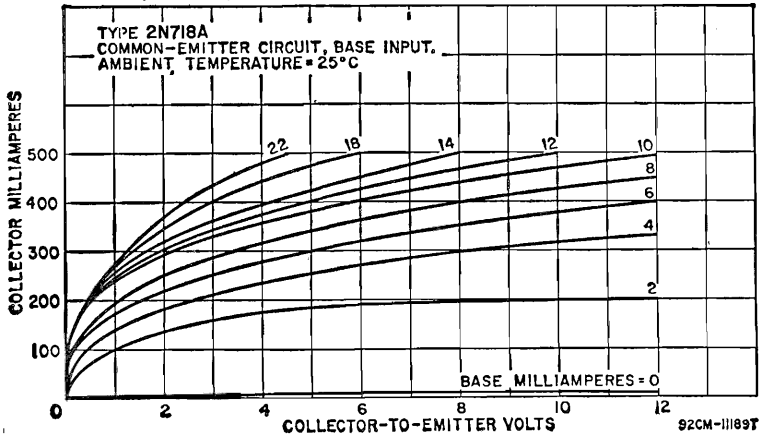

TYPICAL COLLECTOR CHARACTERISTICS

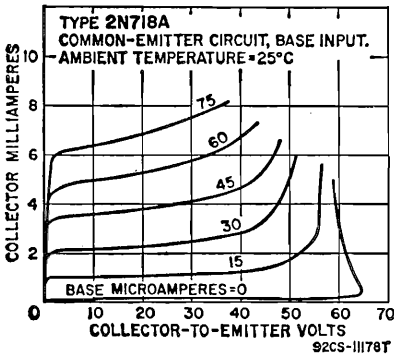

TYPICAL TRANSFER CHARACTERISTICS

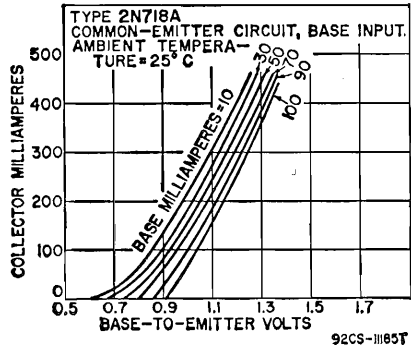

TRANSISTOR

2N720A

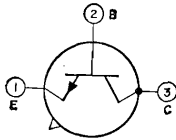

Silicon n-p-n type used in a wide variety of small-signal and high-speed switching applications. JEDEC No. TO-18 package; outline 12, Outlines Section. For curves of typical collector and transfer characteristics, refer to type 2N718A.

MAXIMUM RATINGS

Collector-to-Base Voltage (with emitter open)	120 max	volts
Collector-to-Emitter Voltage (with base open)	80 max	volts
Collector-to-Emitter Voltage (with external base-to-emitter resistance = 10 ohms or less)	100 max	volts
Emitter-to-Base Voltage (with collector open)	7 max	volts
Transistor Dissipation:		
At case temperatures up to 25°C	1.8 max	watts
At ambient temperatures up to 25°C	0.5 max	watt
At case or ambient temperatures above 25°C	See curve	page 80
Temperature Range:		
Operating (junction)	-65 to 200	°C
Storage	-65 to 300	°C
Lead Temperature (for 10 seconds maximum)	255 max	°C

CHARACTERISTICS

Collector-to-Base Breakdown Voltage (with collector $i_a = 0.1$ and emitter current = 0)	120 min	volts
Emitter-to-Base Breakdown Voltage (with emitter $i_a = 0.1$ and collector current = 0)	7 min	volts
Collector-to-Emitter Sustaining Voltage (with pulsed collector $i_a = 100^*$ and base current = 0)	80 min	volts
Collector-to-Emitter Sustaining Voltage (with external base-to-emitter resistance = 10 ohms and pulsed collector $i_a = 100^*$ )	100 min	volts
Base-to-Emitter Saturation Voltage (with pulsed collector $i_a = 150^*$ and pulsed base $i_b = 15^*$ )	1.3 max	volts
Collector-to-Emitter Saturation Voltage (with pulsed collector $i_a = 150^*$ and pulsed base $i_b = 15^*$ )	5 max	volts
Collector-Cutoff Current (with collector-to-base volts = 90 and emitter current = 0)	0.01 max	$\mu a$
Emitter-Cutoff Current (with emitter-to-base volts = 5 and collector current = 0)	0.01 max	$\mu a$
Thermal Resistance:		
Junction-to-case	97 max	°C/watt
Junction-to-ambient	350 max	°C/watt

In Common-Base Circuit

Emitter-to-Base Capacitance (with emitter-to-base volts = 0.5 and collector current = 0)	85 max	pf
Collector-to-Base Capacitance (with collector-to-base volts = 10 and emitter current = 0)	15 max	pf

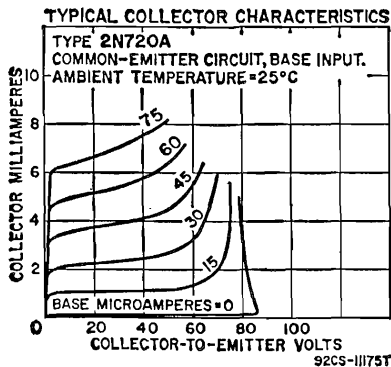

In Common-Emitter Circuit

DC Forward Current-Transfer Ratio:

With collector-to-emitter volts = 10 and pulsed collector ma = 150*	40 to 120
With collector-to-emitter volts = 10 and pulsed collector ma = 10*	35 min
With collector-to-emitter volts = 10 and collector ma = 0.1	20 min
With ambient temperature = -55°C, collector-to-emitter volts = 10, and pulsed collector ma = 10*	20 min

Small-Signal Forward Current-Transfer Ratio:

With collector-to-emitter volts = 5, collector ma = 1, and frequency = 1 kilocycle	30 to 100
With collector-to-emitter volts = 10, collector ma = 5, and frequency = 1 kilocycle	45 min
With collector-to-emitter volts = 10, collector ma = 50, and frequency = 20 Mc	2.5 min

Small-Signal Open-Circuit Reverse Voltage-Transfer Ratio at 1 kilocycle:

With collector-to-emitter volts = 5 and collector ma = 1	1.25 x 10 <sup>-4</sup> max
With collector-to-emitter volts = 10 and collector ma = 5	1.5 x 10 <sup>-4</sup> max

Input Resistance at 1 kilocycle:

With collector-to-emitter volts = 5 and collector ma = 1	20 to 30	ohms
With collector-to-emitter volts = 10 and collector ma = 5	4 to 8	ohms

Output Conductance at 1 kilocycle:

With collector-to-emitter volts = 5 and collector ma = 1	0.5 max	μmho
With collector-to-emitter volts = 10 and collector ma = 5	0.5 max	μmho

\* Pulse duration = 300 μsec; duty factor = 0.02 or less.

\*\* Refer to type 2N2102 for Total-Switching-Time Measurement Circuit.

**2N794**

See List of Discontinued Transistors at end of Technical Data Section for abbreviated data.

**2N795**

See List of Discontinued Transistors at end of Technical Data Section for abbreviated data.

**2N796**

See List of Discontinued Transistors at end of Technical Data Section for abbreviated data.

**TRANSISTOR**

Germanium p-n-p type used in high-speed switching applications in which high reliability and high packaging densities are required. JEDEC No. TO-18; outline 12, Outlines Section.

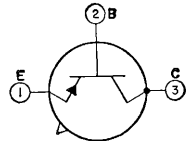

**2N828**

**MAXIMUM RATINGS**

Collector-to-Base Voltage (with emitter open)	-15 max	volts
Collector-to-Emitter Voltage (with external base-to-emitter resistance = 10 ohms or less)	-15 max	volts
Emitter-to-Base Voltage (with collector open)	-2.5 max	volts
Collector Current	-200 max	ma
Transistor Dissipation:		
At case temperatures up to 25°C	300 max	mw
At ambient temperatures up to 25°C	150 max	mw
At case or ambient temperatures above 25°C	See curve	page 80
Temperature Range:		
Operating (junction) and storage	-65 to 100	°C
Lead Temperature (for 10 seconds maximum)	230 max	°C

**CHARACTERISTICS**

Base-to-Emitter Saturation Voltage (with collector ma = -10 and base ma = -1)	0.34 to 0.44	volt
Collector-to-Emitter Saturation Voltage:		
With collector ma = -10 and base ma = -1	-0.2 max	volt
With collector ma = -50 and base ma = -5	-0.25 max	volt
Collector-Cutoff Current (with collector-to-base volts = -6 and emitter current = 0)	-3 max	μa



**In Common-Base Circuit**

Collector-to-Base Capacitance (with collector-to-base volts = -6, emitter current = 0, and frequency = 100 Mc) ..... 6 max pf

**In Common-Emitter Circuit**

DC Forward Current-Transfer Ratio (with collector-to-emitter volts = -0.3 and collector ma = -10) ..... 25 min  
 Small-Signal Forward Current-Transfer Ratio (with collector-to-emitter volts = -1, collector ma = -10, and frequency = 100 Mc) ..... 3 min  
 Gain-Bandwidth Product (with collector-to-emitter volts = -1 and collector ma = -10) ..... 300 min Mc

**TRANSISTOR**

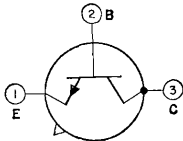

Silicon n-p-n type used in very-high-speed switching applications in equipment requiring high reliability and high packaging densities. JEDEC No. TO-18 package; outline 12, Outlines Section.

**2N834**

**MAXIMUM RATINGS**

Collector-to-Base Voltage (with emitter open) ..... 40 max volts  
 Collector-to-Emitter Voltage (with base short-circuited to emitter) ..... 30 max volts  
 Emitter-to-Base Voltage (with collector open) ..... 5 max volts  
 Collector Current ..... 200 max ma  
 Transistor Dissipation:  
   At case temperatures up to 25°C ..... 1 max watt  
   At ambient temperatures up to 25°C ..... 0.3 max watt  
   At case or ambient temperatures above 25°C ..... See curve page 80  
 Temperature Range:  
   Operating (junction) and storage ..... -65 to 175 °C  
   Lead Temperature (for 10 seconds maximum) ..... 240 max °C

**CHARACTERISTICS**

Base-to-Emitter Saturation Voltage (with collector ma = 10 and base ma = 1) ..... 0.9 max volt  
 Collector-to-Emitter Saturation Voltage:  
   With collector ma = 10 and base ma = 1 ..... 0.25 max volt  
   With collector ma = 50 and base ma = 5 ..... 0.4 max volt  
 Collector-Cutoff Current (with collector-to-base volts = 20 and emitter current = 0) ..... 0.5 max μa

**In Common-Base Circuit**

Collector-to-Base Capacitance (with collector-to-base volts = 10, emitter current = 0, and frequency = 100 Mc) ..... 4 max pf

**In Common-Emitter Circuit**

DC Forward Current-Transfer Ratio (with collector-to-emitter volts = 1 and collector ma = 10) ..... 25 min  
 Small-Signal Forward Current-Transfer Ratio (with collector-to-emitter volts = 15, collector ma = 10, and frequency = 100 Mc) ..... 3.5 min  
 Gain-Bandwidth Product (with collector-to-emitter volts = 15, collector ma = 10, and frequency = 100 Mc) ..... 350 min Mc

**TRANSISTOR**

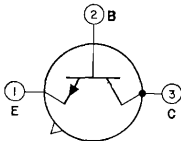

Silicon n-p-n type used in high-speed logic-switching and very-high-frequency amplifier applications. JEDEC No. TO-18 package; outline 12, Outlines Section.

**2N914**

**MAXIMUM RATINGS**

Collector-to-Base Voltage (with emitter open) ..... 40 max volts  
 Collector-to-Emitter Voltage:  
   With external base-to-emitter resistance = 10 ohms or less .. 20 max volts  
   With base open ..... 15 max volts

Emitter-to-Base Voltage (with collector open) .....	5 max	volts
Transistor Dissipation:		
At case temperatures up to 25°C .....	1.2 max	watts
At ambient temperatures up to 25°C .....	0.36 max	watt
At case or ambient temperatures above 25°C .....	See curve	page 80
Temperature Range:		
Operating (junction) .....	-65 to 200	°C
Storage .....	-65 to 300	°C
Lead Temperature (for 10 seconds maximum) .....	300 max	°C

**CHARACTERISTICS**

Base-to-Emitter Saturation Voltage (with collector ma = 10 and base ma = 1) .....	0.7 to 0.8	volt
Collector-to-Emitter Saturation Voltage (with collector ma = 200 and base ma = 20) .....	0.7 max	volt
Collector-Cutoff Current (with collector-to-base volts = 20 and emitter current = 0) .....	0.025 max	µa

**In Common-Base Circuit**

Emitter-to-Base Capacitance (with emitter-to-base volts = -0.5, collector current = 0, and frequency = 140 kilocycles) .....	9 max	pf
Collector-to-Base Capacitance (with collector-to-base volts = 10, emitter ma = 0, and frequency = 140 kilocycles) .....	6 max	pf

**In Common-Emitter Circuit**

DC-Pulse Forward Current-Transfer Ratio: With collector-to-emitter volts = 1 and collector ma = 10 ....	30 to 120	
With collector-to-emitter volts = 5 and collector ma = 500 ...	10 min	
Small-Signal Forward Current-Transfer Ratio (with collector-to-emitter volts = 10 and collector ma = 20) ..	3 min	

**TRANSISTOR**

**2N955**  
**2N955A**

Germanium n-p-n types used in high-speed logic-circuit applications in data-processing equipment. JEDEC No. TO-18 package; outline 12, Outlines Section.

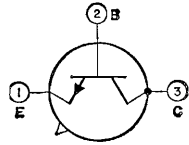

**MAXIMUM RATINGS**

	2N955	2N955A	
Collector-to-Base Voltage (with emitter open)	12 max	12 max	volts
Collector-to-Emitter Voltage (with base open)	8 max	8 max	volts
Emitter-to-Base Voltage (with collector open)	2 max	2 max	volts
Collector Current .....	100 max	150 max	ma
Transistor Dissipation:			
At ambient temperatures up to 25°C .....	150 max	150 max	mW
At ambient temperatures above 25°C .....	See curve	See curve	page 80
Ambient-Temperature Range:			
Operating and storage .....	-65 to 100		°C
Lead Temperature (for 10 seconds maximum) ..	230 max	230 max	

**CHARACTERISTICS**

Base-to-Emitter Saturation Voltage (with collector ma = 30 and base ma = 1) ..	0.3 to 0.6	0.3 to 0.6	volt
Collector-to-Emitter Saturation Voltage: With collector ma = 30 and base ma = 1 ....	0.5 max	0.3 max	volt
With collector ma = 100 and base ma = 5 ...	-	0.6 max	volt
Collector-Cutoff Current (with collector-to-base volts = 5 and emitter current = 0) .....	5 max	5 max	µa
Total Stored Charge (with collector ma = 30 and base ma = 1.5) .....	125 max	65 max	pCoul

**In Common-Base Circuit**

Input Capacitance (with emitter-to-base volts = 0.5 and collector current = 0) .....	10 max	10 max	pf
Output Capacitance (with collector-to-base volts = 5 and emitter current = 0) .....	6 max	6 max	pf

**In Common-Emitter Circuit**

Small-Signal Forward Current-Transfer Ratio (with collector-to-emitter volts = 5, collector ma = 20, and frequency = 100 Mc) .....	10	10	
--	----	----	--

DC Forward Current-Transfer Ratio:

With collector-to-emitter volts = 0.5 and collector ma = 30 .....	30 min	—
With collector-to-emitter volts = 0.3 and collector ma = 30 .....	—	30 min

**TRANSISTOR**

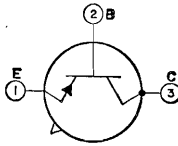

Germanium p-n-p type used in high-speed saturation switching applications in industrial data-processing equipment. JEDEC No. TO-18 package; outline 12, Outlines Section.

**2N960**

**MAXIMUM RATINGS**

Collector-to-Base Voltage .....	-15 max	volts
Collector-to-Emitter Voltage (with external base-to-emitter resistance = 0) .....	-15 max	volts
Collector-to-Emitter Voltage .....	-7 max	volts
Emitter-to-Base Voltage .....	-2.5 max	volts
Collector Current .....	-100 max	ma
<b>Transistor Dissipation:</b>		
At case temperatures up to 25°C .....	300 max	mw
At ambient temperatures up to 25°C .....	150 max	mw
At case or ambient temperatures above 25°C .....	See curve	page 80
<b>Temperature Range:</b>		
Operating .....	-55 to 100	°C
Storage .....	-65 to 100	°C
Lead Temperature (for 10 seconds maximum) .....	230 max	°C

**CHARACTERISTICS**

Collector-to-Emitter Saturation Voltage:

With collector ma = -10 and base ma = -1 .....	-0.2 max	volt
With collector ma = -50 and base ma = -5 .....	-0.4 max	volt
With collector ma = -100 and base ma = -10 .....	-0.7 max	volt

Collector-Cutoff Current (with collector-to-base volts = -6 and emitter current = 0) .....

	-3 max	µa
--	--------	----

*In Common-Base Circuit*

Emitter-to-Base Capacitance (with emitter-to-base volts = -1, collector current = 0, and frequency = 100 kc) .....	3.5 max	pf
Collector-to-Base Capacitance (with collector-to-base volts = -10, emitter current = 0, and frequency = 1 Mc) .....	4 max	pf
Gain-Bandwidth Product (with collector-to-base volts = -1, emitter current = 20, and frequency = 100 Mc) .....	300 min	Mc

*In Common-Emitter Circuit*

DC Forward Current-Transfer Ratio:

With collector-to-emitter volts = -0.3 and collector ma = -10 .....	20 min
With collector-to-emitter volts = -1 and collector ma = -50 .....	20 min
With collector-to-emitter volts = -1 and collector ma = -100 .....	20 min

**TRANSISTOR**

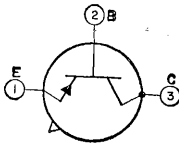

Germanium p-n-p type used in high-speed saturated switching applications in industrial data-processing equipment. JEDEC No. TO-18 package; outline 12, Outlines Section.

**2N961**

**MAXIMUM RATINGS**

Collector-to-Base Voltage .....	-12 max	volts
Collector-to-Emitter Voltage (with external base-to-emitter resistance = 0) .....	-12 max	volts
Collector-to-Emitter Voltage .....	-7 max	volts
Emitter-to-Base Voltage .....	-2 max	volts
Collector Current .....	-100 max	ma
<b>Transistor Dissipation:</b>		
At case temperatures up to 25°C .....	300 max	mw
At ambient temperatures up to 25°C .....	150 max	mw
At case or ambient temperatures above 25°C .....	See curve	page 80

Temperature Range:		
Operating .....	-55 to 100	°C
Storage .....	-65 to 100	°C
Lead Temperature (for 10 seconds maximum) .....	230 max	°C

**CHARACTERISTICS**

Collector-to-Emitter Saturation Voltage:		
With collector ma = -10 and base ma = -1 .....	-0.2 max	volt
With collector ma = -50 and base ma = -5 .....	-0.4 max	volt
With collector ma = -100 and base ma = -10 .....	-0.7 max	volt
Collector-Cutoff Current (with collector-to-base volts = -6 and emitter current = 0) .....	-3 max	µa

*In Common-Base Circuit*

Emitter-to-Base Capacitance (with emitter-to-base volts = -1, collector current = 0, and frequency = 100 kc) .....	3.5 max	pf
Collector-to-Base Capacitance (with collector-to-base volts = -10, emitter current = 0, and frequency = 1 Mc) .....	4 max	pf
Gain-Bandwidth Product (with collector-to-base volts = -1, emitter current = 20, and frequency = 100 Mc) .....	300 min	Mc

*In Common-Emitter Circuit*

DC Forward Current-Transfer Ratio:		
With collector-to-emitter volts = -0.3 and collector ma = -10 .....	20 min	
With collector-to-emitter volts = -1 and collector ma = -50 .....	20 min	
With collector-to-emitter volts = -1 and collector ma = -100 .....	20 min	

**TRANSISTOR**

**2N962**

Germanium p-n-p type used in high-speed saturated switching applications in industrial data-processing equipment. JEDEC No. TO-18 package; outline 12, Outlines Section.

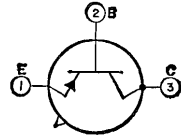

**MAXIMUM RATINGS**

Collector-to-Base Voltage .....	-12 max	volts
Collector-to-Emitter Voltage (with external base-to-emitter resistance = 0) .....	-12 max	volts
Collector-to-Emitter Voltage .....	-7 max	volts
Emitter-to-Base Voltage .....	-1.25 max	volts
Collector Current .....	-100 max	ma
Transistor Dissipation:		
At case temperatures up to 25°C .....	300 max	mw
At ambient temperatures up to 25°C .....	150 max	mw
At case or ambient temperatures above 25°C .....	See curve	page 80
Temperature Range:		
Operating .....	-55 to 100	°C
Storage .....	-65 to 100	°C
Lead Temperature (for 10 seconds maximum) .....	230 max	°C

**CHARACTERISTICS**

Collector-to-Emitter Saturation Voltage:		
With collector ma = -10 and base ma = -1 .....	-0.2 max	volt
With collector ma = -50 and base ma = -5 .....	-0.4 max	volt
With collector ma = -100 and base ma = -10 .....	-0.7 max	volt
Collector-Cutoff Current (with collector-to-base volts = -6 and emitter current = 0) .....	-3 max	µa

*In Common-Base Circuit*

Emitter-to-Base Capacitance (with emitter-to-base volts = -1, collector current = 0, and frequency = 100 kc) .....	3.5 max	pf
Collector-to-Base Capacitance (with collector-to-base volts = -10, emitter current = 0, and frequency = 1 Mc) .....	4 max	pf
Gain-Bandwidth Product (with collector-to-base volts = -1, emitter current = 20, and frequency = 100 Mc) .....	300 min	Mc

*In Common-Emitter Circuit*

DC Forward Current-Transfer Ratio:		
With collector-to-emitter volts = -0.3 and collector ma = -10 .....	20 min	
With collector-to-emitter volts = -1 and collector ma = -50 .....	20 min	
With collector-to-emitter volts = -1 and collector ma = -100 .....	20 min	

TRANSISTOR

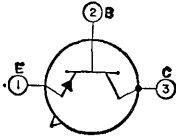

Germanium p-n-p type used in high-speed saturated switching applications in industrial data-processing equipment. JEDEC No. TO-18 package; outline 12, Outlines Section.

2N963

MAXIMUM RATINGS

Collector-to-Base Voltage .....	-12 max	vols
Collector-to-Emitter Voltage (with external base-to-emitter resistance = 0) .....	-12 max	vols
Collector-to-Emitter Voltage .....	-7 max	vols
Emitter-to-Base Voltage .....	-1.25 max	vols
Collector Current .....	-100 max	ma
Transistor Dissipation:		
At case temperatures up to 25°C .....	300 max	mw
At ambient temperatures up to 25°C .....	150 max	mw
At case or ambient temperatures above 25°C .....	See curve	page 80
Temperature Range:		
Operating .....	-55 to 100	°C
Storage .....	-65 to 100	°C
Lead Temperature (for 10 seconds maximum) .....	230 max	°C

CHARACTERISTICS

Collector-to-Emitter Saturation Voltage (with collector ma = -10 and base ma = -1) .....	-0.2 max	volt
Collector-Cutoff Current (with collector-to-base volts = -6 and emitter current = 0) .....	-5 max	μa

In Common-Base Circuit

Emitter-to-Base Capacitance (with emitter-to-base volts = -1, collector current = 0, and frequency = 100 kc) .....	4 max	pf
Collector-to-Base Capacitance (with collector-to-base volts = -5, emitter current = 0, and frequency = 1 Mc) .....	5 max	pf
Gain-Bandwidth Product (with collector-to-base volts = 1, emitter current = 20, and frequency = 100 Mc) .....	250 min	Mc

In Common-Emitter Circuit

DC Forward Current-Transfer Ratio (with collector-to-emitter volts = -0.3 and collector ma = -10) .....	20 min
---	--------

TRANSISTOR

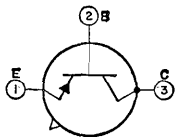

Germanium p-n-p type used in high-speed saturated switching applications in industrial data-processing equipment. JEDEC No. TO-18 package; outline 12, Outlines Section. This type is identical with type

2N964

2N960 except for the following items:

CHARACTERISTICS

Collector-to-Emitter Saturation Voltage:		
With collector ma = -10 and base ma = -1 .....	-0.18 max	volt
With collector ma = -50 and base ma = -5 .....	-0.35 max	volt
With collector ma = -100 and base ma = -10 .....	-0.6 max	volt

In Common-Emitter Circuit

DC Forward Current-Transfer Ratio:		
With collector-to-emitter volts = -0.3 and collector ma = -10 .....	40 min	
With collector-to-emitter volts = -1 and collector ma = -50 .....	40 min	
With collector-to-emitter volts = -1 and collector ma = -100 .....	40 min	

**TRANSISTOR**

**2N965**

Germanium p-n-p type used in high-speed saturated switching applications in industrial data-processing equipment. JEDEC No. TO-18 package; outline 12, Outlines Section. This type is identical with type

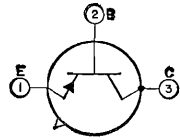

2N961 except for the following items:

**CHARACTERISTICS**

Collector-to-Emitter Saturation Voltage:		
With collector ma = -10 and base ma = -1 .....	-0.18 max	volt
With collector ma = -50 and base ma = -5 .....	-0.35 max	volt
With collector ma = -100 and base ma = -10 .....	-0.6 max	volt

*In Common-Emitter Circuit*

DC Forward Current-Transfer Ratio:	
With collector-to-emitter volts = -0.3 and collector ma = -10	40 min
With collector-to-emitter volts = -1 and collector ma = -50	40 min
With collector-to-emitter volts = -1 and collector ma = -100	40 min

**TRANSISTOR**

**2N966**

Germanium p-n-p type used in high-speed saturated switching applications in industrial data-processing equipment. JEDEC No. TO-18 package; outline 12, Outlines Section. This type is identical with type

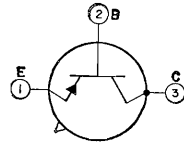

2N962 except for the following items:

**CHARACTERISTICS**

Collector-to-Emitter Saturation Voltage:		
With collector ma = -10 and base ma = -1 .....	-0.18 max	volt
With collector ma = -50 and base ma = -5 .....	-0.35 max	volt
With collector ma = -100 and base ma = -10 .....	-0.6 max	volt

*In Common-Emitter Circuit*

DC Forward Current-Transfer Ratio:	
With collector-to-emitter volts = -0.3 and collector ma = -10	40 min
With collector-to-emitter volts = -1 and collector ma = -50	40 min
With collector-to-emitter volts = -1 and collector ma = -100	40 min

**TRANSISTOR**

**2N967**

Germanium p-n-p type used in high-speed saturated switching applications in industrial data-processing equipment. JEDEC No. TO-18 package; outline 12, Outlines Section. This type is identical with type

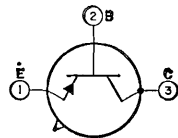

2N963 except for the following items:

**CHARACTERISTICS**

*In Common-Emitter Circuit*

DC Forward Current-Transfer Ratio (with collector-to-emitter volts = -0.3 and collector ma = -10) .....	40 min
---	--------

**TRANSISTOR**

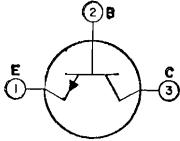

Germanium n-p-n type used in low-noise small-signal audio-frequency amplifier applications. It is used in input stages of audio-frequency amplifiers operating from extremely small input signals, such

**2N1010**

as high-fidelity preamplifiers, tape-recorder amplifiers, microphone preamplifiers, and hearing aids, in which low noise is an important design consideration. JEDEC No. TO-1 package; outline 4, Outlines Section.

**MAXIMUM RATINGS**

Collector-to-Base Voltage (with emitter open) .....	10 max	volts
Collector-to-Emitter Voltage .....	10 max	volts
Emitter-to-Base Voltage (with collector open) .....	10 max	volts
Collector Current .....	2 max	ma
Emitter Current .....	-2 max	ma
Transistor Dissipation:		
At ambient temperatures up to 55°C .....	20 max	mw
Ambient-Temperature Range:		
Operating .....	-65 to 55	°C
Storage .....	-65 to 85	°C

**CHARACTERISTICS**

Collector-Cutoff Current (with collector-to-base volts = 10 and emitter current = 0) .....	10 max	μa
Emitter-Cutoff Current (with emitter-to-base volts = 2.5 and collector current = 0) .....	6 max	μa

*In Common-Base Circuit*

Small-Signal Forward-Current-Transfer-Ratio Cutoff Frequency (with collector-to-base volts = 3.5 and collector ma = 0.3) ...	2	Mc
--	---	----

*In Common-Emitter Circuit*

Small-Signal Forward Current-Transfer Ratio at 1 kilocycle (with collector-to-emitter volts = 3.5 and collector ma = 0.3)	35	
Noise Figure (with generator resistance = 1000 ohms and integrated noise bandwidth = 15 kilocycles) .....	5	db

See List of Discontinued Transistors at end of Technical Data Section for abbreviated data.

**2N1014**

**TRANSISTOR**

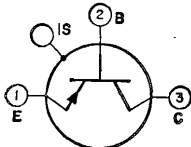

Germanium p-n-p type used in rf and if amplifier circuits; oscillator, mixer, and converter circuits; and low-level video-amplifier circuits in industrial and military equipment.

**2N1023**

It is used in the design of rf circuits having high input-circuit efficiency, excellent operating stability, good automatic-gain-control capabilities over a wide range of input-signal levels, and good signal-to-noise ratio. The drift-field construction provides low base resistance and collector-transition capacitance, and improves performance at high frequencies. The center lead is internally connected to the metal case to provide integral shielding which minimizes interlead capacitance and coupling to adjacent circuit components. For curves of typical collector characteristics and for video-amplifier circuit, refer to type 2N384. JEDEC No. TO-44 package; outline 16, Outlines Section.

**MAXIMUM RATINGS**

Collector-to-Base Voltage (with emitter open) .....	-40 max	volts
Collector-to-Emitter Voltage (with base-to-emitter volts = 0.5) .....	-40 max	volts

Emitter-to-Base Voltage (with collector open) .....	-0.5 max	volt
Collector Current .....	-10 max	ma
Emitter Current .....	10 max	ma
Transistor Dissipation:		
At case temperatures up to 25°C .....	240 max	mw
At ambient temperatures up to 25°C .....	120 max	mw
At case or ambient temperatures above 25°C .....	See curve page 80	
Temperature Range:		
Operating (junction) and storage .....	-65 to 100	°C

**CHARACTERISTICS**

Collector-to-Base Breakdown Voltage (with collector $\mu a = -50$ and emitter current = 0) .....	-80	volts
Collector-to-Emitter Reach-Through Voltage (with emitter-to-base volts = -0.5) .....	-80	volts
Collector-Cutoff Current (with collector-to-base volts = -12 and emitter current = 0) .....	-4	$\mu a$
Emitter-Cutoff Current (with emitter-to-base volts = -0.5 and collector current = 0) .....	-1	$\mu a$
Thermal Resistance:		
Junction-to-case .....	0.31 max	°C/mw
Junction-to-ambient .....	0.62 max	°C/mw

*In Common-Base Circuit*

Small-Signal Forward-Current-Transfer-Ratio Cutoff Frequency (with collector-to-base volts = -12 and emitter ma = 1.5) ..	120	Mc
Input Resistance with ac output circuit shorted (with collector- to-base volts = -12, emitter ma = 1.5, and frequency = 50 Mc)	25	ohms
Output Resistance with ac input circuit shorted (with collector- to-base volts = -12, emitter ma = 1.5 and frequency = 50 Mc)	8000	ohms
Collector-to-Base Capacitance (with collector-to-base volts = -12 and emitter current = 0) .....	2	pf
Power Gain (with collector-to-base volts = -12, emitter ma = 1.5, and frequency = 50 Mc) .....	21	db

*In Common-Emitter Circuit*

Small-Signal Forward Current-Transfer Ratio (with collector-to- emitter volts = -12, emitter ma = 1.5 and frequency = 1 kilocycle) .....	60	
Input Resistance with ac output circuit shorted (with collector- to-emitter volts = -12, emitter ma = 1.5, and frequency = 30 Mc) .....	100	ohms
Output Resistance with ac input circuit shorted (with collector- to-emitter volts = -12, emitter ma = -1.5, and frequency = 30 Mc) .....	8000	ohms
Power Gain (with collector-to-emitter volts = -12, emitter ma = 1.5, and frequency = 30 Mc) .....	23	db

**TYPICAL OPERATION IN POWER-SWITCHING CIRCUIT**

DC Collector-to-Emitter Voltage .....	-12	volts
DC Emitter Current .....	5.8	ma
Source Impedance .....	150	ohms
Capacitive Load .....	16	pf
Frequency Response .....	20 cps to 11 Mc	
Pulse Rise Time .....	0.032	$\mu sec$
Voltage Gain .....	26	db
Maximum Peak-to-Peak Output Voltage .....	20	volts

**TRANSISTOR**

**2N1066**

Germanium p-n-p type used in rf and if amplifier circuits; oscillator, mixer, and converter circuits; and low-level video-amplifier circuits in industrial and military equipment. It is used in the design of rf circuits

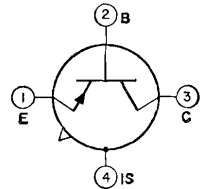

having high input-circuit efficiency, excellent operating stability, good automatic-gain-control capabilities over a wide range of input-signal levels, and good signal-to-noise ratio. The drift-field construction provides low base resistance and collector-transition capacitance, and improves performance at high frequencies. A fourth lead is internally connected to the metal case to provide integral shielding which minimizes interlead capacitance and coupling to adjacent circuit components. JEDEC No. TO-33 package; outline 13, Outlines Section. This type is electrically identical with type 2N1023.



**POWER TRANSISTOR**

**2N1067**

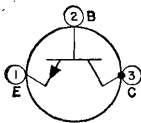

Silicon n-p-n type used in a wide variety of intermediate-power switching and amplifier applications in industrial and military equipment. It is used in power-switching, dc-to-dc converter, inverter, chopper,

solenoid and relay control circuits; in oscillator, regulator, and pulse-amplifier circuits; and as a class A or class B push-pull audio and servo amplifier. It features low saturation resistance, high current and power dissipation, high beta at high current, and excellent high-temperature performance. JEDEC No. TO-8 package; outline 8, Outlines Section.

**MAXIMUM RATINGS**

Collector-to-Base Voltage (with emitter open)	60 max	volts
Collector-to-Emitter Voltage:		
With base short-circuited to emitter	60 max	volts
With base open	45 max	volts
Emitter-to-Base Voltage (with collector open)	12 max	volts
Collector Current	0.5 max	ampere
Emitter Current	-0.5 max	ampere
Base Current	0.2 max	ampere
Transistor Dissipation:		
At case temperatures up to 25°C	5 max	watts
At case temperatures above 25°C	See curve	page 80
Temperature Range:		
Operating (junction) and storage	-65 to 175	°C

**CHARACTERISTICS**

Emitter-to-Base Voltage (with collector-to-emitter volts = 4 and collector ma = 200)	-1.2	volts
Collector-Cutoff Current (with collector-to-base volts = 60 and emitter current = 0)	15	μa
Emitter-Cutoff Current (with emitter-to-base volts = 12 and collector current = 0)	1	μa
Collector Current:		
With collector-to-emitter volts = 60 and base short-circuited to emitter	100	μa
With collector-to-emitter volts = 30 and base open	100	μa
Thermal Resistance:		
Junction-to-case	15	°C/watt
Junction-to-ambient	100 max	°C/watt
Thermal Time Constant	8	msec

**In Common-Base Circuit**

Small-Signal Forward-Current-Transfer-Ratio Cutoff Frequency (with collector-to-base volts = 28 and collector ma = 5) ....	1.5	Mc
--	-----	----

**TYPICAL COLLECTOR CHARACTERISTICS**

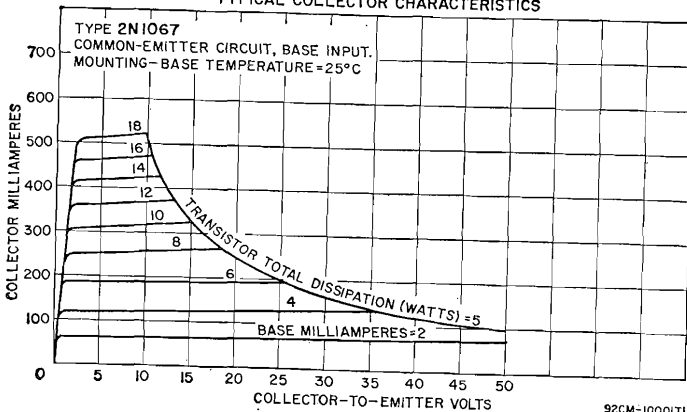

In Common-Emitter Circuit

DC Forward Current-Transfer Ratio (with collector-to-emitter volts = 4 and collector ma = 200) .....	35	
DC Collector-to-Emitter Saturation Resistance (with collector ma = 200 and base ma = 20) .....	3	ohms

TYPICAL OPERATION IN POWER-SWITCHING CIRCUIT BELOW

DC Collector Supply Voltage ( $B_2$ ) .....	12	volts
DC Base Supply Voltage ( $B_1$ ) .....	-12	volts
Generator Resistance .....	50	ohms
On DC Collector Current ( $I_C$ ) .....	200	ma
Turn-On DC Base Current ( $I_{B1}$ ) .....	20	ma
Turn-Off DC Base Current ( $I_{B2}$ ) .....	-20	ma
Switching Time:		
Delay time ( $t_d$ ) .....	0.2	$\mu$ sec
Rise time ( $t_r$ ) .....	1.2	$\mu$ sec
Storage time ( $t_s$ ) .....	0.7	$\mu$ sec
Fall time ( $t_f$ ) .....	0.9	$\mu$ sec

TYPICAL TRANSFER CHARACTERISTICS

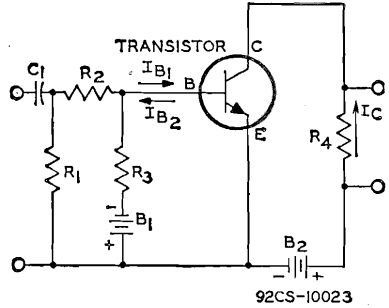
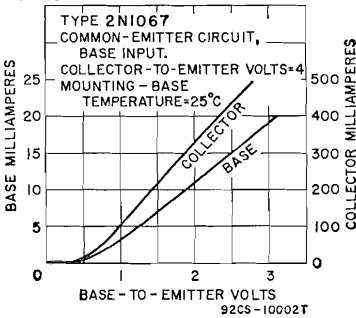

- $B_1, B_2 = 12$  volts
- $C_1 = 5 \mu f$ , electrolytic, 25 volts
- $R_1 = 51$  ohms, 1 watt
- $R_2 = 280$  ohms, 0.5 watt
- $R_3 = 700$  ohms, 1 watt
- $R_4 = 59$  ohms, 2 watts

POWER TRANSISTOR

2N1068

Silicon n-p-n type used in a wide variety of intermediate-power switching and amplifier applications in industrial and military equipment. It is used in power switching, dc-to-dc converter, inverter, chopper,

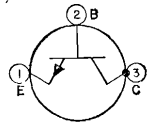

solenoid and relay control circuits; in oscillator, regulator, and pulse-amplifier circuits; and as a class A or class B push-pull audio and servo amplifier. It features low saturation resistance, high current and power dissipation, high beta at high current, and excellent high-temperature performance. JEDEC No. TO-8 package; outline 8, Outlines Section.

MAXIMUM RATINGS

Collector-to-Base Voltage .....	60 max	volts
Collector-to-Emitter Voltage:		
With base short-circuited to emitter .....	60 max	volts
With base open .....	45 max	volts
Emitter-to-Base Voltage (with collector open) .....	12 max	volts
Collector Current .....	1.5 max	amperes
Emitter Current .....	-1.5 max	amperes
Base Current .....	0.5 max	ampere
Transistor Dissipation:		
At case temperatures up to 25°C .....	10 max	watts
At case temperatures above 25°C .....	See curve	page 80
Temperature Range:		
Operating (junction) and storage .....	-65 to 175	°C

**CHARACTERISTICS**

Emitter-to-Base Voltage (with collector-to-emitter volts = 4 and collector ma = 750) .....	-1.2	volts
Collector-Cutoff Current (with collector-to-base volts = 60 and emitter current = 0) .....	15	$\mu$ a
Emitter-Cutoff Current (with emitter-to-base volts = 12 and collector current = 0) .....	1	$\mu$ a
Collector Current:		
With collector-to-emitter volts = 60 and base short-circuited to emitter .....	100	$\mu$ a
With collector-to-emitter volts = 30 and base open .....	100	$\mu$ a
Thermal Resistance:		
Junction-to-case .....	7.5	$^{\circ}$ C/watt
Junction-to-ambient .....	100 max	$^{\circ}$ C/watt
Thermal Time Constant .....	8	msec

*In Common-Base Circuit*

Small-Signal Forward-Current-Transfer-Ratio Cutoff Frequency (with collector-to-base volts = 28 and collector ma = 5) ....	1.5	Mc
--	-----	----

*In Common-Emitter Circuit*

DC Forward Current-Transfer Ratio (with collector-to-emitter volts = 4 and collector ma = 750) .....	38	
DC Collector-to-Emitter Saturation Resistance (with collector ma = 750 and base ma = 20) .....	3	ohms

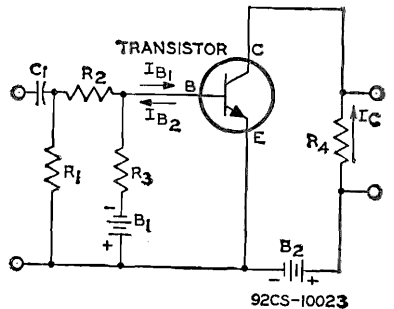
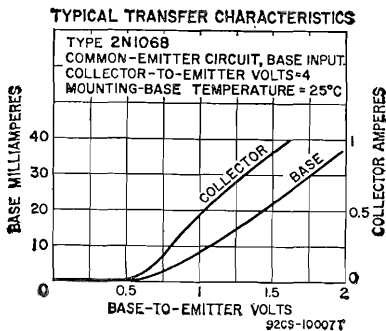
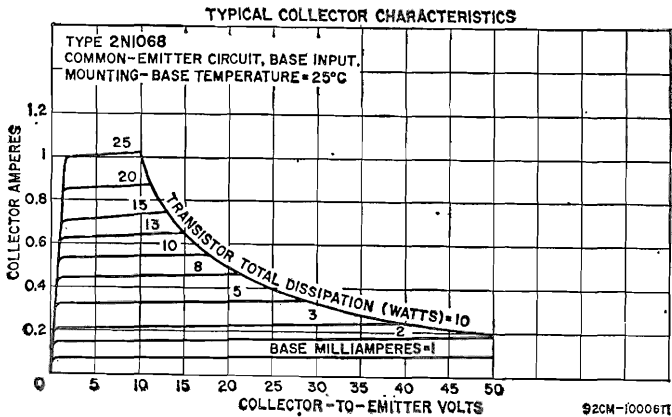

- $B_1, B_2 = 12$  volts
- $C_1 = 5 \mu$ f, electrolytic, 25 volts
- $R_1 = 51$  ohms, 1 watt
- $R_2 = 100$  ohms, 0.5 watt
- $R_3 = 320$  ohms, 1 watt
- $R_4 = 15.9$  ohms, 2 watts

**TYPICAL OPERATION IN POWER-SWITCHING CIRCUIT**

DC Collector Supply Voltage ( $E_2$ ) .....	12	volts
DC Base Supply Voltage ( $B_1$ ) .....	-12	volts
Generator Resistance .....	50	ohms
On DC Collector Current ( $I_c$ ) .....	750	ma
Turn-On DC Base Current ( $I_{B1}$ ) .....	50	ma
Turn-Off DC Base Current ( $I_{B2}$ ) .....	-50	ma
Switching Time:		
Delay time ( $t_d$ ) .....	0.2	$\mu$ sec
Rise time ( $t_r$ ) .....	1.6	$\mu$ sec
Storage time ( $t_s$ ) .....	1	$\mu$ sec
Fall time ( $t_f$ ) .....	1.8	$\mu$ sec

**POWER TRANSISTOR**

**2N1069**

Silicon n-p-n type used in a wide variety of intermediate-power switching and amplifier applications in industrial and military equipment. It is used in power switching, dc-to-dc converter, inverter, chopper,

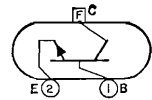

solenoid and relay control circuits; in oscillator, regulator, and pulse-amplifier circuits; and as a class A or class B push-pull audio and servo amplifier. It features low saturation resistance, high current and power dissipation, high beta at high current, and excellent high-temperature performance. JEDEC No. TO-3 package; outline 5, Outlines Section. This type is identical with type 2N1070 except for the following:

**CHARACTERISTICS**

Emitter-to-Base Voltage (with collector-to-emitter volts = 4 and collector amperes = 1.5) .....	-1.7	volts
---	------	-------

*In Common-Emitter Circuit*

DC Collector-to-Emitter Saturation Resistance (with collector amperes = 1.5 and base ma = 300) .....	0.7	ohm
--	-----	-----

**POWER TRANSISTOR**

**2N1070**

Silicon n-p-n type used in a wide variety of intermediate-power switching and amplifier applications in industrial and military equipment. It is used in power switching, dc-to-dc converter, inverter, chopper, sole-

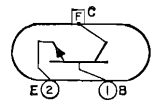

noid and relay control circuits; in oscillator, regulator, and pulse-amplifier circuits; and as a class A or class B push-pull audio and servo amplifier. It features low saturation resistance, high current and power dissipation, high beta at high current, and excellent high-temperature performance. JEDEC No. TO-3 package; outline 5, Outlines Section.

**MAXIMUM RATINGS**

Collector-to-Base Voltage (with emitter open) .....	60 max	volts
Collector-to-Emitter Voltage:		
With base short-circuited to emitter .....	60 max	volts
With base open .....	45 max	volts
Emitter-to-Base Voltage (with collector open) .....	9 max	volts
Collector Current .....	4 max	amperes
Emitter Current .....	-4 max	amperes
Base Current .....	1.3 max	amperes
Transistor Dissipation:		
At mounting-flange temperatures up to 25°C .....	50 max	watts
At mounting-flange temperatures above 25°C .....	See curve page 80	
Temperature Range:		
Operating (junction) and storage .....	-65 to 175	°C

**CHARACTERISTICS**

Emitter-to-Base Voltage (with collector-to-emitter volts = 4 and collector amperes = 1.5)	-1.1	volts
Collector-Cutoff Current (with collector-to-base volts = 60 and emitter current = 0)	25	$\mu$ a
Emitter-Cutoff Current (with emitter-to-base volts = 9 and collector current = 0)	1	$\mu$ a
Collector Current:		
With collector-to-emitter volts = 60 and base short-circuited to emitter	200	$\mu$ a
With collector-to-emitter volts = 45 and base open	200	$\mu$ a
Thermal Resistance:		
Junction-to-mounting-flange	1	$^{\circ}$ C/watt
Thermal Time Constant	10	msec

**In Common-Base Circuit**

Small-Signal Forward-Current-Transfer-Ratio Cutoff Frequency (with collector-to-base volts = 12 and collector ma = 100)	1.2	Mc
---	-----	----

**In Common-Emitter Circuit**

DC Forward Current-Transfer Ratio (with collector-to-emitter volts = 4 and collector amperes = 1.5)	20	
DC Collector-to-Emitter Saturation Resistance (with collector amperes = 1.5 and base ma = 1.5)	0.4	ohm

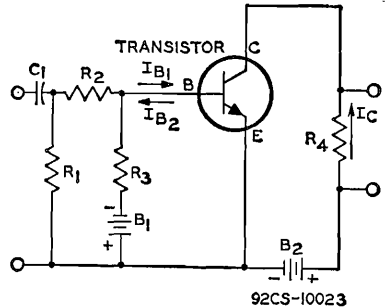
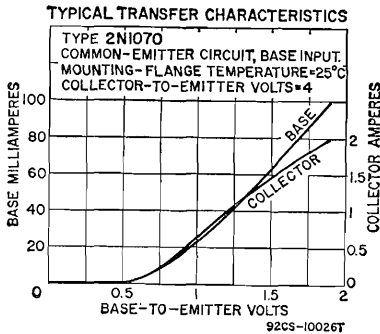
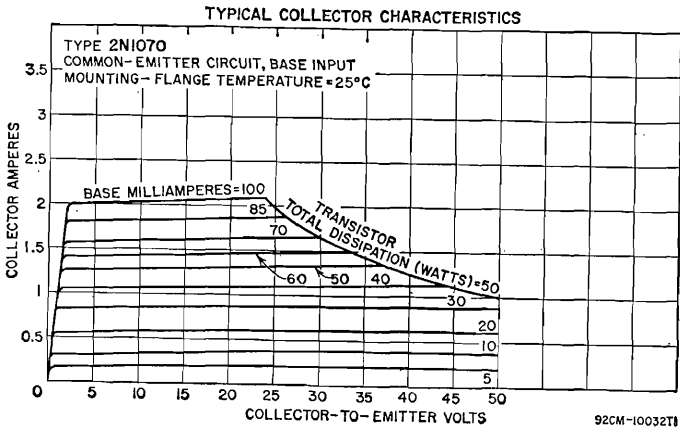

- B<sub>1</sub>, B<sub>2</sub> = 12 volts
- C<sub>1</sub> = 5 $\mu$ f, electrolytic, 25 volts
- R<sub>1</sub> = 51 ohms, 1 watt
- R<sub>2</sub> = 10 ohms, 0.5 watt
- R<sub>3</sub> = 75 ohms, 1 watt
- R<sub>4</sub> = 7.5 ohms, 2 watts

**TYPICAL OPERATION IN POWER-SWITCHING CIRCUIT**

DC Collector Supply Voltage ( $B_c$ ) .....	12	volts
DC Base Supply Voltage ( $B_b$ ) .....	12	volts
Generator Resistance .....	50	ohms
On DC Collector Current ( $I_c$ ) .....	1.5	amperes
Turn-On DC Base Current ( $I_{B1}$ ) .....	200	ma
Turn-Off DC Base Current ( $I_{B2}$ ) .....	-200	ma
Switching Time:		
Delay time ( $t_d$ ) .....	0.2	$\mu$ sec
Rise time ( $t_r$ ) .....	1.8	$\mu$ sec
Storage time ( $t_s$ ) .....	0.8	$\mu$ sec
Fall time ( $t_f$ ) .....	1.4	$\mu$ sec

**TRANSISTOR**

**2N1090**

Germanium n-p-n type used in high-current, medium-speed switching circuits in electronic computers. JEDEC No. TO-5 package; outline 6, Outlines Section.

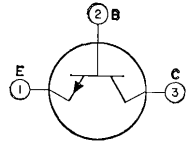

**MAXIMUM RATINGS**

Collector-to-Base Voltage (with emitter open) .....	25 max	volts
Collector-to-Emitter Voltage:		
With base-to-emitter volts = -1 .....	18 max	volts
With base open .....	15 max	volts
Emitter-to-Base Voltage (with collector open) .....	20 max	volts
Collector Current .....	400 max	ma
Transistor Dissipation:		
At ambient temperatures up to 25°C .....	120 max	mw
At ambient temperature of 55°C .....	35 max	mw
At ambient temperature of 71°C .....	10 max	mw
Ambient-Temperature Range:		
Operating and storage .....	-65 to 85	°C

**CHARACTERISTICS**

Base-to-Emitter Voltage:		
With collector ma = 20 and base ma = 0.67 .....	0.4 max	volt
With collector ma = 200 and base ma = 10 .....	1.5 max	volts
Collector-to-Emitter Saturation Voltage:		
With collector ma = 20 and base ma = 0.67 .....	0.2 max	volt
With collector ma = 200 and base ma = 10 .....	0.3 max	volt
Collector-Cutoff Current (with collector-to-base volts = 12 and emitter current = 0) .....	8 max	$\mu$ a
Stored Base Charge (with collector ma = 20 and base ma = 1.33) .....	1600 max	pcoul

*In Common-Base Circuit*

Collector-to-Base Capacitance (with collector-to-base volts = 6 and emitter current = 0) .....	25 max	pf
Forward-Current-Transfer-Ratio Cutoff Frequency (with collector-to-base volts = 6 and emitter ma = -1) .....	5 min	Mc

*In Common-Emitter Circuit*

Forward Current-Transfer Ratio:		
With collector-to-emitter volts = 0.2 and collector ma = 20 ..	30 min	
With collector-to-emitter volts = 0.3 and collector ma = 200 ..	20 min	

**TRANSISTOR**

**2N1091**

Germanium n-p-n type used in high-current, medium-speed switching circuits in electronic computers. JEDEC No. TO-5 package; outline 6, Outlines Section. This type is identical with type 2N1090 except for the

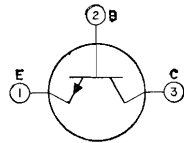

following items:

**MAXIMUM RATINGS**

Collector-to-Emitter Voltage:		
With base-to-emitter volts = -1 .....	15 max	volts
With base open .....	12 max	volts

**CHARACTERISTICS**

Base-to-Emitter Voltage:		
With collector ma = 20 and base ma = 0.5 .....	0.35 max	volt
With collector ma = 200 and base ma = 6.7 .....	1.1 max	volts
Collector-to-Emitter Saturation Voltage:		
With collector ma = 20 and base ma = 0.5 .....	0.2 max	volt
With collector ma = 200 and base ma = 6.7 .....	0.3 max	volt
Collector-Cutoff Current (with collector-to-base volts = 12 and emitter current = 0) .....	8 max	$\mu$ A
Stored Base Charge (with collector ma = 20 and base ma = 1) .....	1000 max	pcoul

*In Common-Base Circuit*

Forward-Current-Transfer-Ratio Cutoff Frequency (with collector-to-base volts = 6 and emitter ma = -1) ...	10 min	Mc
Collector-to-Base Capacitance (with collector-to-base volts = 6 and emitter current = 0) .....	25 max	pf

*In Common-Emitter Circuit*

Forward Current-Transfer Ratio:		
With collector-to-emitter volts = 0.2 and collector ma = 20 ..	40 min	
With collector-to-emitter volts = 0.3 and collector ma = 200 ..	30 min	

**POWER TRANSISTOR**

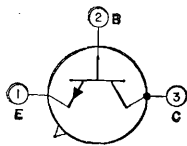

Silicon n-p-n type used in a wide variety of intermediate-power switching and amplifier applications in industrial and military equipment. It is used in power switching, dc-to-dc converter, inverter, chop-

**2N1092**

per, solenoid and relay control circuits; in oscillator, regulator, and pulse-amplifier circuits; and as a class A or class B push-pull audio and servo amplifier. It features low saturation resistance, high current and power dissipation, high beta at high current, and excellent high-temperature performance. JEDEC No. TO-5 package; outline 6, Outlines Section.

**MAXIMUM RATINGS**

Collector-to-Base Voltage (with emitter open) .....	60 max	volts
Collector-to-Emitter Voltage:		
With base short-circuited to emitter .....	60 max	volts
With base open .....	30 max	volts
Emitter-to-Base Voltage (with collector open) .....	12 max	volts
Collector Current .....	0.5 max	ampere
Emitter Current .....	-0.5 max	ampere
Base Current .....	0.2 max	ampere
Transistor Dissipation:		
At case temperatures up to 25°C .....	2 max	watts
At case temperatures above 25°C .....	See curve page 80	
Temperature Range:		
Operating (junction) and storage .....	-65 to 175	°C

**CHARACTERISTICS**

Emitter-to-Base Voltage (with collector-to-emitter volts = 4 and collector ma = 200) .....	-1.2	volts
Collector-Cutoff Current (with collector-to-base volts = 60 and emitter current = 0) .....	15	$\mu$ A
Emitter-Cutoff Current (with emitter-to-base volts = 12 and collector current = 0) .....	1	$\mu$ A
Collector Current:		
With collector-to-emitter volts = 60 and base short-circuited to emitter .....	100	$\mu$ A
With collector-to-emitter volts = 30 and base open .....	100	$\mu$ A
Thermal Resistance:		
Junction-to-case .....	35	°C/watt
Junction-to-ambient .....	225 max	°C/watt
Thermal Time Constant .....	8	msec

*In Common-Base Circuit*

Small-Signal Forward-Current-Transfer-Ratio Cutoff Frequency (with collector-to-base volts = 28 and collector ma = 5) ...	1.5	Mc
--	-----	----

*In Common-Emitter Circuit*

DC Forward Current-Transfer Ratio (with collector-to-emitter volts = 4 and collector ma = 200) .....	35	
---	----	--

DC Collector-to-Emitter Saturation Resistance  
(with collector ma = 200 and base ma = 20) ..... 3 ohms

**TYPICAL OPERATION IN POWER-SWITCHING CIRCUIT BELOW**

DC Collector Supply Voltage ( $B_2$ ) .....	12	volts
DC Base Supply Voltage ( $B_1$ ) .....	-12	volts
Generator Resistance .....	50	ohms
On DC Collector Current ( $I_c$ ) .....	200	ma
Turn-On DC Base Current ( $I_{B1}$ ) .....	20	ma
Turn-Off DC Base Current ( $I_{B2}$ ) .....	-20	ma
Switching Time:		
Delay time ( $t_d$ ) .....	0.2	$\mu$ sec
Rise time ( $t_r$ ) .....	1.2	$\mu$ sec
Storage time ( $t_s$ ) .....	0.7	$\mu$ sec
Fall time ( $t_f$ ) .....	0.9	$\mu$ sec

**TYPICAL TRANSFER CHARACTERISTICS**

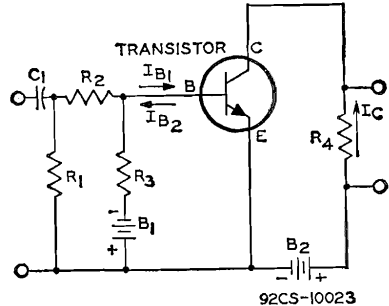
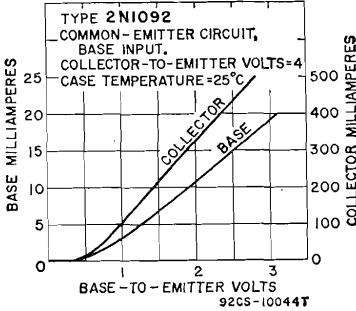

- $B_1, B_2 = 12$  volts
- $C_1 = 5 \mu$ f, electrolytic, 25 volts
- $R_1 = 51$  ohms, 1 watt
- $R_2 = 280$  ohms, 0.5 watt
- $R_3 = 700$  ohms, 1 watt
- $R_4 = 59$  ohms, 2 watts

**TYPICAL COLLECTOR CHARACTERISTICS**

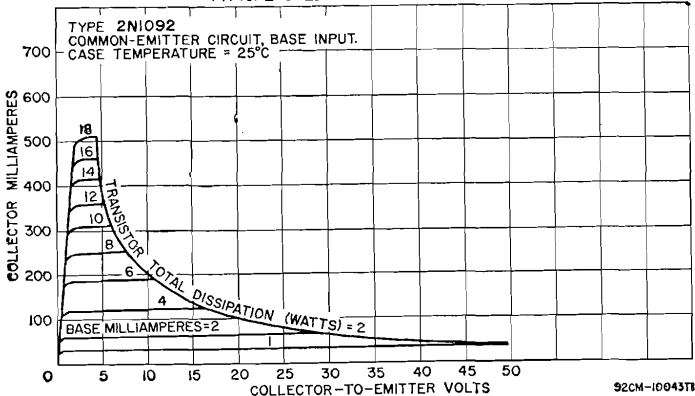

**POWER TRANSISTOR**

**2N1099**

Germanium p-n-p type used in a wide variety of switching and amplifier applications in industrial and military equipment requiring transistors having high voltage, current, and dissipation values. It is used in

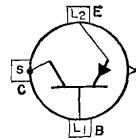

power-switching, voltage- and current-regulating, dc-to-dc converter, inverter,



power-supply, and relay- and solenoid-actuating circuits; and in low-frequency oscillator and audio-amplifier service. This type is designed to provide satisfactory performance under extreme environmental conditions of temperature, moisture, and altitude; it is stud-mounted to provide positive heat-sink contact, and has a cold-weld seal to insure reliable performance under severe environmental conditions. JEDEC No. TO-36 package; outline 14, Outlines Section. This type is identical with type 2N173 except for the following items:

**MAXIMUM RATINGS**

Collector-to-Base Voltage (with emitter-to-base volts = 1.5) . . . . .	-80 max	volts
Emitter-to-Base Voltage (with collector open) . . . . .	-40 max	volts

**CHARACTERISTICS**

Collector-to-Emitter Breakdown Voltage:		
With base short-circuited to emitter and collector amperes = -0.3 . . . . .	-70 min	volts
With base open and collector amperes = -0.3 . . . . .	-60	volts
Collector-to-Emitter Reach-Through Voltage . . . . .	-80 min	volts
Collector-Cutoff Current (with collector-to-base volts = -80 and emitter current = 0) . . . . .	-2	ma

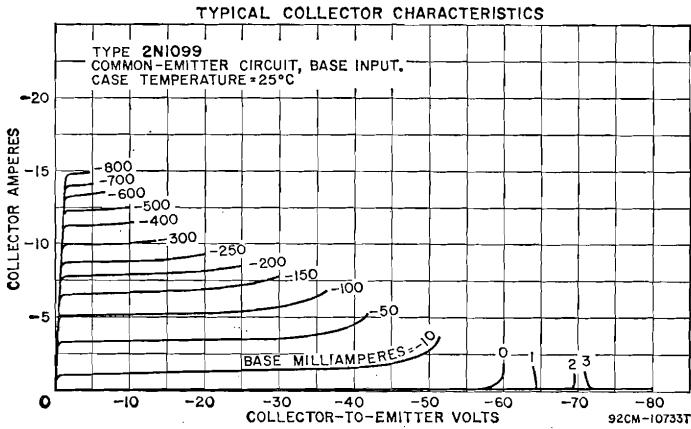

**POWER TRANSISTOR**

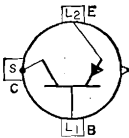

Germanium p-n-p type used in a wide variety of switching and amplifier applications in industrial and military equipment requiring transistors having high voltage, current, and dissipation values. It is used in

**2N1100**

power-switching, voltage- and current-regulating, dc-to-dc converter, inverter, power-supply, and relay- and solenoid-actuating circuits; and in low-frequency oscillator and audio-amplifier service. This type is designed to provide satisfactory performance under extreme environmental conditions of temperature, moisture, and altitude; it is stud-mounted to provide positive heat-sink contact, and has a cold-weld seal to insure reliable performance under severe environmental conditions. JEDEC No. TO-36 package; outline 14, Outlines Section. This type is identical with type 2N174 except for the following items:

**MAXIMUM RATINGS**

Collector-to-Base Voltage (with emitter-to-base volts = -1.5) ..	-100 max	volts
Emitter-to-Base Voltage (with collector open) . . . . .	-80 max	volts

**CHARACTERISTICS**

Collector-to-Emitter Breakdown Voltage (with base short-circuited to emitter and collector amperes = -0.3) .....	-80 min	volts
Emitter-to-Base Voltage (with collector-to-base volts = -100 and emitter current = 0) .....	-1 max	volt
Collector-to-Emitter Reach-Through Voltage .....	-100 min	volts
Emitter-Cutoff Current (with emitter-to-base volts = -80 and collector current = 0) .....	-1	ma
Collector-Cutoff Current (with collector-to-base volts = -100 and emitter current = 0) .....	-2	ma

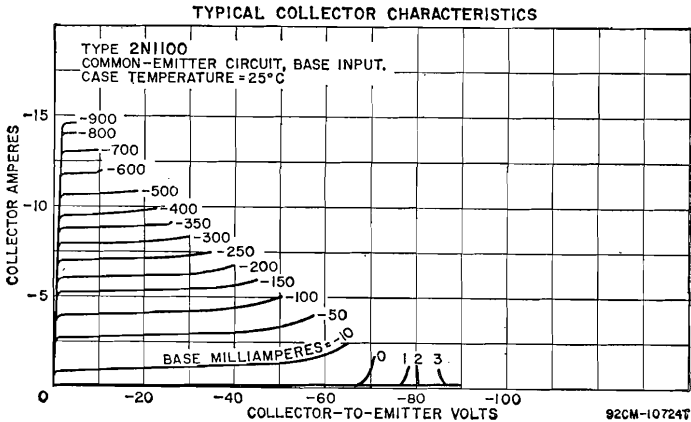

**TRANSISTOR**

**2N1169**

Germanium n-p-n bidirectional type used in medium-speed switching circuits in data-processing equipment. This type is designed so that the emitter can also function as a collector and the collector can

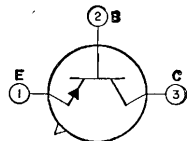

also function as an emitter. It is especially useful in bidirectional switching, core-driver, and ac-signal relay circuits. JEDEC No. TO-5 package; outline 6, Outlines Section.

**MAXIMUM RATINGS**

Collector-to-Base Voltage (with emitter open) .....	25 max	volts
Emitter-to-Base Voltage (with collector open) .....	25 max	volts
Collector-to-Emitter Voltage:		
With base-to-emitter volts = -1 .....	20 max	volts
With base open .....	18 max	volts
Collector Current .....	±400 max	ma
Emitter Current .....	±400 max	ma
Transistor Dissipation:		
At ambient temperatures up to 25°C .....	120 max	mw
At ambient temperature of 55°C .....	35 max	mw
At ambient temperature of 71°C .....	10 max	mw
Ambient-Temperature Range:		
Operating .....	-65 to 71	°C
Storage .....	-65 to 85	°C

**CHARACTERISTICS**

Base-to-Emitter Voltage (with collector ma = 200 and base ma = 10) .....	1.5 max	volts
Collector-to-Emitter Saturation Voltage (with collector ma = 200 and base ma = 10) .....	0.3 max	volt
Collector-Cutoff Current (with collector-to-base volts = 12 and emitter open) .....	10 max	µa

**In Common-Base Circuit**

Forward-Current-Transfer-Ratio Cutoff Frequency (with collector-to-base volts = 6 and collector ma = 1) . . . . .	4.5 min	Mc
Collector-to-Base Capacitance (with collector-to-base volts = 6 and collector current = 0) . . . . .	19	pf

**In Common-Emitter Circuit**

Forward Current-Transfer Ratio (with collector-to-emitter volts = 0.3 and collector ma = 200) . . . . .	20 min	
---	--------	--

**TRANSISTOR**

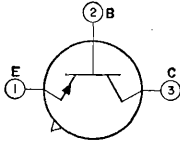

Germanium n-p-n bidirectional type used in medium-speed switching circuits in data-processing equipment. This type is designed so that the emitter can also function as a collector and the collector can

**2N1170**

also function as an emitter. It is particularly useful in bidirectional switching, core-driver, and ac-signal relay circuits. JEDEC No. TO-5 package; outline 6, Outlines Section. This type is identical with type 2N1169 except for the following items:

**MAXIMUM RATINGS**

Collector-to-Base Voltage (with emitter open) . . . . .	40 max	volts
Emitter-to-Base Voltage (with collector open) . . . . .	40 max	volts
Collector-to-Emitter Voltage: With base-to-emitter volts = -1 . . . . .	39 max	volts
With base open . . . . .	20 max	volts

**CHARACTERISTICS**

Collector-Cutoff Current (with collector-to-base volts = 12 and emitter open) . . . . .	8 max	$\mu$ a
---	-------	---------

**TRANSISTOR**

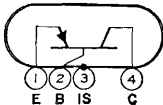

Germanium p-n-p type used in radio-frequency amplifier applications in FM and AM/FM radio receivers. In a typical FM tuner operating at 100 megacycles, this type can provide a power gain of

**2N1177**

14 db. JEDEC No. TO-45 package; outline 17, Outlines Section.

**MAXIMUM RATINGS**

Collector-to-Base Voltage (with emitter open) . . . . .	-30 max	volts
Emitter-to-Base Voltage (with collector open) . . . . .	-1 max	volt
Collector Current . . . . .	-10 max	ma
Emitter Current . . . . .	10 max	ma
Transistor Dissipation: At ambient temperatures up to 25°C . . . . .	80 max	mw
At ambient temperature of 55°C . . . . .	50 max	mw
At ambient temperature of 71°C . . . . .	23 max	mw
Operating-Temperature Range: Operating . . . . .	-65 to 71	°C
Storage . . . . .	-65 to 85	°C

**CHARACTERISTICS**

Collector-to-Base Breakdown Voltage (with emitter-to-base volts = -0.5 and collector $\mu$ a = -50) . . . . .	-30 min	volts
Collector-Cutoff Current (with collector-to-base volts = -12 and emitter current = 0) . . . . .	-12 max	$\mu$ a
Emitter-Cutoff Current (with emitter-to-base volts = -1 and collector current = 0) . . . . .	-12 max	$\mu$ a

**In Common-Base Circuit**

Small-Signal Forward Current-Transfer Ratio (with collector-to-base volts = -12, collector ma = -1, and frequency = 1 kilocycle) . . . . .	0.99	
--	------	--

Small-Signal Forward-Current-Transfer-Ratio Cutoff Frequency  
(with collector-to-base volts = -12 and collector ma = -1) 140 Mc

*In Common-Emitter Circuit*

DC Forward Current-Transfer Ratio (with collector-to-emitter  
volts = -12, collector ma = -1, and frequency = 1 kilocycle) 100

**TYPICAL OPERATION**

DC Collector-to-Base Voltage .....	-12	volts
DC Collector Current .....	-1.5	ma
Signal Frequency .....	100	Mc
Input Resistance (with ac output circuit shorted) .....	45	ohms
Output Resistance (with ac input circuit shorted) .....	3800	ohms
Extrinsic Transconductance .....	24250	$\mu$ mhos
Collector-to-Base Output Capacitance .....	2	pf
Maximum Available Power Gain .....	14	db

TYPICAL COLLECTOR CHARACTERISTICS

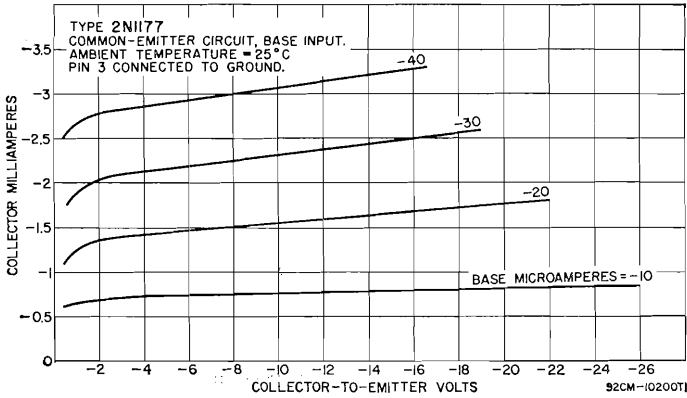

**TRANSISTOR**

**2N1178**

Germanium p-n-p type used in radio-frequency oscillator applications in FM and AM/FM radio receivers. In local-oscillator service at a frequency above the incoming rf signal, this type can supply an rf

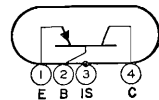

mixer stage with required oscillator-injection voltage for optimum mixing throughout the FM band. JEDEC No. TO-45 package; outline 17, Outlines Section. This type is identical with type 2N1177 except for the following items:

**CHARACTERISTICS**

*In Common-Base Circuit*

Small-Signal Forward Current-Transfer Ratio (with collector-to-base volts = -12, collector ma = -1, and frequency = 1 kilocycle) 0.976

*In Common-Emitter Circuit*

DC Forward Current-Transfer Ratio (with collector-to-emitter  
volts = -12, collector ma = -1, and frequency = 1 kilocycle) 40

**TYPICAL OPERATION**

DC Collector-to-Base Voltage .....	-11	volts
Collector Current .....	-2.5	ma

Signal Frequency .....	110.7	Mc
Extrinsic Transconductance .....	21800	$\mu$ mhos
Collector-to-Base Output Capacitance .....	2	pf

**TRANSISTOR**

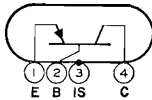

**2N1179**

Germanium p-n-p type used in radio-frequency mixer applications in FM and AM/FM radio receivers. In a typical FM tuner operating at 100 megacycles, this type can provide a conversion power gain of 17 db. JEDEC No. TO-45 package; outline 17, Outlines Section. This type is identical with type 2N1177 except for the following items:

**MAXIMUM RATINGS**

*In Common-Base Circuit*

Small-Signal Forward Current-Transfer Ratio (with collector-to-base volts = -12, collector ma = -1, and frequency = 1 kilocycle) .....	0.938	Mc
--	-------	----

*In Common-Base Circuit*

DC Forward Current-Transfer Ratio (with collector-to-emitter volts = -12, collector ma = -1, and frequency = 1 kilocycle)	80	
---	----	--

**TYPICAL OPERATION**

DC Collector-to-Base Voltage .....	-12	volts
DC Collector Current .....	-0.8	ma
Signal Frequency .....	100	Mc
Input Resistance (with ac output circuit shorted) .....	40	ohms
Output Resistance (with ac input circuit shorted and intermediate frequency = 10.7 Mc) .....	90000	ohms
RMS Base-to-Emitter Oscillator Injection Voltage .....	125	mv
Extrinsic Conversion Transconductance .....	7500	$\mu$ mhos
Collector-to-Base Output Capacitance .....	2	pf
Maximum Available Conversion Power Gain .....	17	db

**TRANSISTOR**

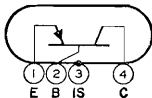

**2N1180**

Germanium p-n-p type used in intermediate-frequency amplifier applications in FM and AM/FM radio receivers. In a three-stage 10.7-megacycle if amplifier circuit, this type can provide a useful power gain of 65 db with neutralization or 57 db without neutralization. JEDEC No. TO-45 package; outline 17, Outlines Section. This type is identical with type 2N1177 except for the following items:

**MAXIMUM RATINGS**

Emitter-to-Base Voltage (with collector open) .....	-0.5 max	volt
---	----------	------

**CHARACTERISTICS**

Emitter-Cutoff Current (with emitter-to-base volts = -0.5 and collector current = 0) .....	-12 max	$\mu$ a
--	---------	---------

*In Common-Base Circuit*

Small-Signal Forward Current-Transfer Ratio (with collector-to-base volts = -12, collector ma = -1, and frequency = 1 kilocycle) .....	0.988	
Small-Signal Forward-Current-Transfer-Ratio Cutoff Frequency (with collector-to-base volts = -12 and collector ma = -1) ..	100	Mc

**In Common-Emitter Circuit**

DC Forward Current-Transfer Ratio (with collector-to-emitter volts = -12, collector ma = -1, and frequency = 1 kilocycle) 80

**TYPICAL OPERATION**

DC Collector-to-Emitter Voltage .....	-12		volts
DC Collector Current .....	-1.5		ma
Signal Frequency .....	10.7		Mc
Input Resistance (with ac output circuit shorted) .....	325		ohms
Output Resistance (with ac input circuit shorted) .....	24000		ohms
Extrinsic Transconductance .....	40250		$\mu$ mhos
Collector-to-Base Output Capacitance .....	2		pf
Maximum Power Gain:			
	<i>Single Stage</i>	<i>Three Stages</i>	
Available .....	35	35	db
Useful:			
In neutralized circuit .....	23	21.6	db
In unneutralized circuit .....	20	19	db

**POWER TRANSISTOR**

**2N1183**  
**2N1183A**  
**2N1183B**

Germanium p-n-p types used in intermediate-power switching and low-frequency amplifier applications in industrial and military equipment. They are used in power switching, dc-to-dc converters, choppers, sole-

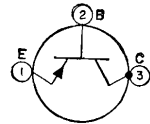

noid drivers, and relay controls; in oscillator, regulator, and pulse-amplifier circuits; and as class A or class B amplifiers for servo and linear amplifier applications. JEDEC No. TO-8 package; outline 8, Outlines Section.

**MAXIMUM RATINGS**

	2N1183	2N1183A	2N1183B	
Collector-to-Base Voltage (with emitter open) .....	-45 max	-60 max	-80 max	volts
Collector-to-Emitter Voltage:				
With emitter-to-base volts = -1.2 .....	-45 max	-60 max	-80 max	volts
With base short-circuited to emitter .....	-35 max	-50 max	-60 max	volts
With base open .....	-20 max	-30 max	-40 max	volts
Emitter-to-Base Voltage (with collector open) .....	-20 max	-20 max	-20 max	volts
Collector Current .....	-3 max	-3 max	-3 max	amperes
Emitter Current .....	3.5 max	3.5 max	3.5 max	amperes
Base Current .....	-0.5 max	-0.5 max	-0.5 max	ampere
Transistor Dissipation:				
At case temperatures up to 25°C .....	7.5 max	7.5 max	7.5 max	watts
At ambient temperatures up to 25°C .....	1 max	1 max	1 max	watt
At case or ambient temperatures above 25°C .....				
Temperature Range:				
Operating (junction) and storage ..		-65 to 100		

See curve page 80

**CHARACTERISTICS**

	2N1183	2N1183A	2N1183B	
Collector-to-Emitter Breakdown Voltage:				
With emitter-to-base volts = -1.2 and collector ma = -0.25 .....	-45 min	-60 min	-80 min	volts
With base short-circuited to emitter and collector ma = -50 .....	-35 min	-50 min	-60 min	volts
With base open and collector ma = -50 .....	-20 min	-30 min	-40 min	volts
Emitter-to-Base Voltage (with collector-to-emitter volts = -2 and collector ma = -400) ..	1.5 max	1.5 max	1.5 max	volts
Collector-Cutoff Current:				
With collector-to-base volts = -1.5 and emitter current = 0 .....	-30 max	-30 max	-30 max	$\mu$ a
With collector-to-base volts = -45 and emitter current = 0 .....	-250 max	-	-	$\mu$ a
With collector-to-base volts = -60 and emitter current = 0 .....	-	-250 max	-	$\mu$ a
With collector-to-base volts = -80 and emitter current = 0 .....	-	-	-250 max	$\mu$ a
Emitter-Cutoff Current (with emitter-to-base volts = -20 and collector current = 0) .....	-100 max	-100 max	-100 max	$\mu$ a

Collector Saturation Resistance (with collector $i_a = -400$ and base $i_a = -40$ ) .....	1.25 max	1.25 max	1.25 max	ohms
Thermal Resistance:				
Junction-to-base .....	10 max	10 max	10 max	$^{\circ}\text{C}/\text{watt}$
Junction-to-ambient .....	75 max	75 max	75 max	$^{\circ}\text{C}/\text{watt}$

**In Common-Base Circuit**

Small-Signal Forward-Current-Transfer-Ratio Cutoff Frequency (with collector-to-base volts = -6 and emitter $i_a = 1$ ) .....	500 min	500 min	500 min	kc
---	---------	---------	---------	----

**In Common-Emitter Circuit**

DC Forward Current-Transfer Ratio (with collector-to-emitter volts = -2 and collector $i_a = -400$ ) ..	20 to 60	20 to 60	20 to 60	
---	----------	----------	----------	--

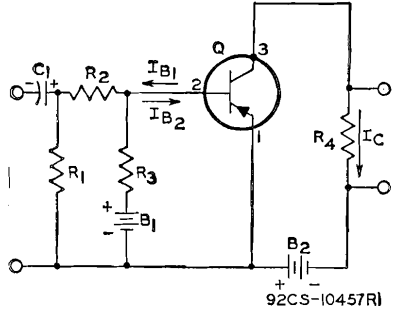
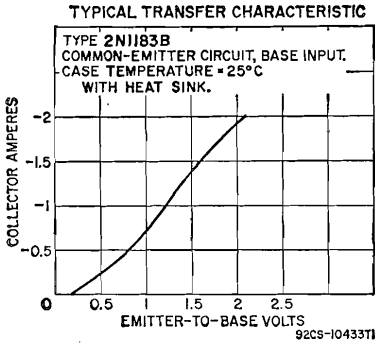

- $B_1, B_2 = 12$  volts
- $C_1 = 10$   $\mu\text{f}$ , electrolytic, 25 volts
- $R_1 = 51$  ohms, 2 watts
- $R_2 = 120$  ohms, 2 watts
- $R_3 = 230$  ohms, 1 watt
- $R_4 = 29.5$  ohms, 5 watts

**TYPICAL OPERATION IN POWER-SWITCHING CIRCUIT ABOVE**

DC Collector Supply Voltage ( $B_2$ ) .....	-12	volts
DC Base Supply Voltage ( $B_1$ ) .....	12	volts
Generator Resistance .....	50	ohms
On DC Collector Current ( $I_c$ ) .....	-400	ma
Turn-On DC Base Current ( $I_{B1}$ ) .....	-40	ma
Turn-Off DC Base Current ( $I_{B2}$ ) .....	40	ma
Switching Time:		
Delay time ( $t_d$ ) .....	0.2	$\mu\text{sec}$
Rise time ( $t_r$ ) .....	2	$\mu\text{sec}$
Storage time ( $t_s$ ) .....	1.8	$\mu\text{sec}$
Fall time ( $t_f$ ) .....	1.4	$\mu\text{sec}$

**TYPICAL COLLECTOR CHARACTERISTICS**

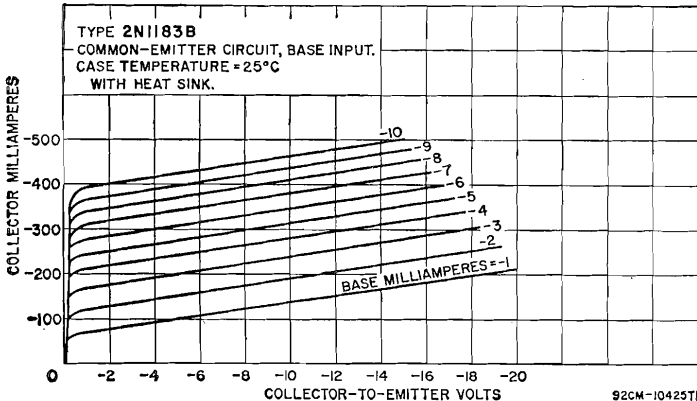

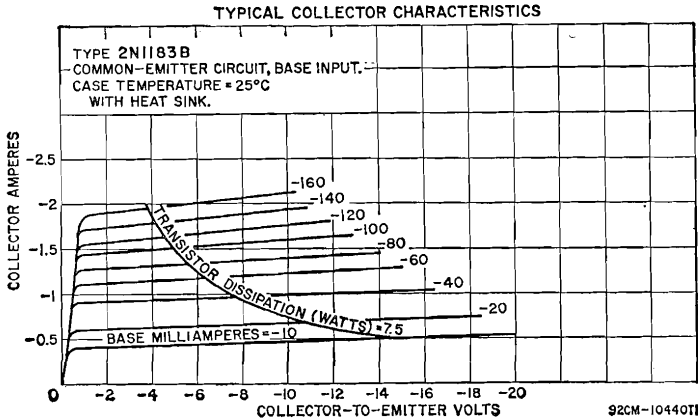

**POWER TRANSISTOR**

**2N1184**  
**2N1184A**  
**2N1184B**

Germanium p-n-p types used in intermediate-power switching and low-frequency amplifier applications in industrial and military equipment. They are used in power switching, dc-to-dc converters, choppers, solenoid drivers, and relay controls; in oscillator, regulator, and pulse-amplifier circuits; and as class A or class B amplifiers for servo and linear amplifier applications. JEDEC No. TO-8 package; outline 8, Outlines Section. These types are identical with types 2N1183, 2N1183A and 2N1183B, respectively, except for the following items:

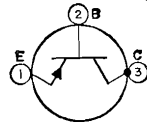

They are used in power switching, dc-to-dc converters, choppers, solenoid drivers, and relay controls; in oscillator, regulator, and pulse-amplifier circuits; and as class A or class B amplifiers for servo and linear amplifier applications. JEDEC No. TO-8 package; outline 8, Outlines Section. These types are identical with types 2N1183, 2N1183A and 2N1183B, respectively, except for the following items:

**CHARACTERISTICS**

*In Common-Emitter Circuit*

DC Forward Current-Transfer Ratio (with collector-to-emitter volts = -2 and collector ma = -400) ..... 40 to 120

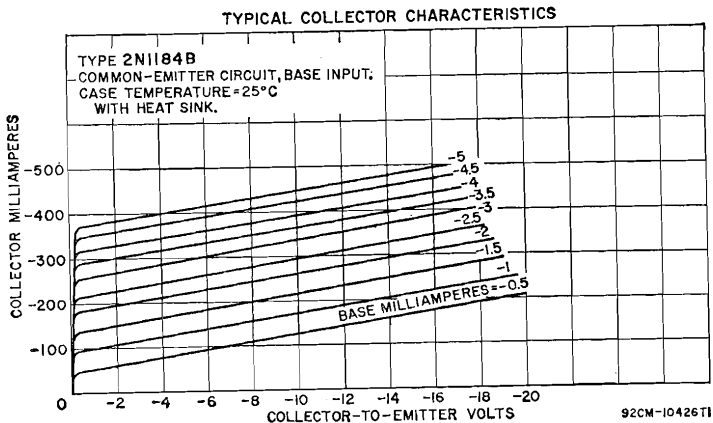



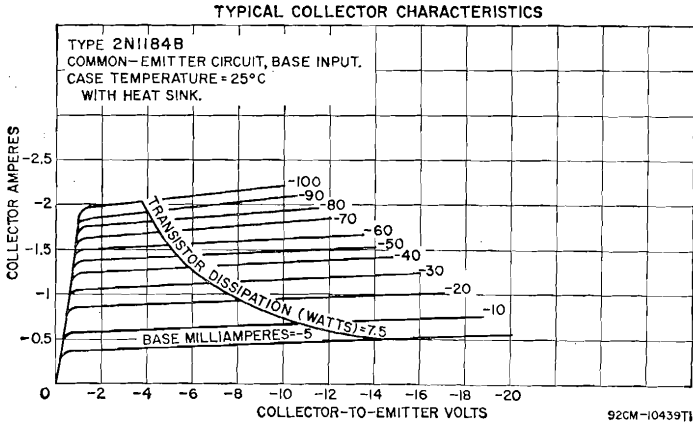

See List of Discontinued Transistors at end of Technical Data Section for abbreviated data.

**2N1213**

See List of Discontinued Transistors at end of Technical Data Section for abbreviated data.

**2N1214**

See List of Discontinued Transistors at end of Technical Data Section for abbreviated data.

**2N1215**

See List of Discontinued Transistors at end of Technical Data Section for abbreviated data.

**2N1216**

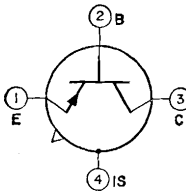

**TRANSISTOR**

Germanium p-n-p type used in rf and if amplifier circuits; oscillator, mixer and converter circuits; and low-level video-amplifier circuits in industrial and military equipment. It is used in the design of rf circuits

**2N1224**

having high input-circuit efficiency, excellent operating stability, good automatic-gain-control capabilities over a wide range of input-signal levels, and good signal-to-noise ratio. The drift-field construction provides low base resistance and collector-transition capacitance, and improves performance at high frequencies. A fourth lead internally connected to the metal case provides integral shielding which minimizes interlead capacitance and coupling to adjacent circuit components. JEDEC No. TO-33 package; outline 13, Outlines Section. This type is electrically identical with type 2N274.

## TRANSISTOR

## 2N1225

Germanium p-n-p type used in rf and if amplifier circuits; oscillator, mixer, and converter circuits; and low-level video-amplifier circuits in industrial and military equipment. It is used in the design of rf circuits

having high input-circuit efficiency, excellent operating stability, good automatic-gain-control capabilities over a wide range of input-signal levels, and good signal-to-noise ratio. The drift-field construction provides low base resistance and collector-transition capacitance, and improves performance at high frequencies. A fourth lead internally connected to the metal case provides integral shielding which minimizes interlead capacitance and coupling to adjacent circuit components. JEDEC No. TO-33 package; outline 13, Outlines Section. This type is electrically identical with type 2N384.

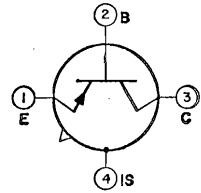

## TRANSISTOR

## 2N1226

Germanium p-n-p type used in rf and if amplifier circuits; oscillator, mixer, and converter circuits; and low-level video-amplifier circuits in industrial and military equipment. It is used in the design of rf circuits

having high input-circuit efficiency, excellent operating stability, good automatic-gain-control capabilities over a wide range of input-signal levels, and good signal-to-noise ratio. The drift-field construction provides low base resistance and collector-transition capacitance, and improves performance at high frequencies. A fourth lead internally connected to the metal case provides integral shielding which minimizes interlead capacitance and coupling to adjacent circuit components. JEDEC No. TO-33 package; outline 13, Outlines Section. This type is electrically identical with type 2N274 except for the following items:

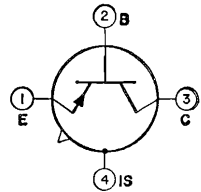

## MAXIMUM RATINGS

Collector-to-Base Voltage (with emitter open)	-60 max	volts
Collector-to-Emitter Voltage (with base-to-emitter volts = 0.5)	-60 max	volts

## CHARACTERISTICS

Collector-to-Base Breakdown Voltage (with collector $\mu\text{a} = -50$ and emitter current = 0)	-100	volts
Collector-to-Emitter Reach-Through Voltage (with emitter-to-base volts = -0.5)	-100	volts

## TRANSISTOR

## 2N1300

Germanium p-n-p type used in high-speed switching applications in data-processing equipment. JEDEC No. TO-5 package; outline 6, Outlines Section.

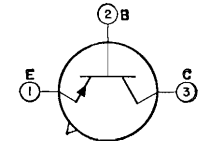

## MAXIMUM RATINGS

Collector-to-Base Voltage (with emitter open)	-13 max	volts
Collector-to-Emitter Voltage (with base open)	-12 max	volts
Emitter-to-Base Voltage (with collector open)	-1 max	volt
Collector Current	-100 max	ma
Emitter Current	100 max	ma
Transistor Dissipation:		
At ambient temperatures up to 25°C	150 max	mW
At ambient temperatures above 25°C	See curve	page 80

Ambient-Temperature Range:		
Operating and storage .....	-65 to 85	°C
Lead Temperature (for 10 seconds maximum) .....	255 max	°C

**CHARACTERISTICS**

Base-to-Emitter Voltage (with collector ma = -40 and base ma = -1) .....	-0.4 max	volt
Collector-Cutoff Current (with collector-to-base volts = -6 and emitter open) .....	-3 max	μa
Total Stored Charge (with collector ma = -10 and base ma = -1) .....	400 max	pcoul

*In Common-Base Circuit*

Collector Capacitance (with collector-to-base volts = -6 and emitter current = 0) .....	12 max	pf
---	--------	----

*In Common-Emitter Circuit*

Forward Current-Transfer Ratio (with collector-to-emitter volts = -0.3 and collector ma = -10) .....	30 min	
Gain-Bandwidth Product (with collector-to-emitter volts = -3 and collector ma = -10) .....	25 min	Mc

**TRANSISTOR**

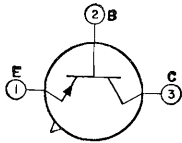

Germanium p-n-p type used in high-speed switching applications in data-processing equipment. JEDEC No. TO-5 package; outline 6, Outlines Section. Maximum ratings for this type are the same as for type

**2N1301**

2N1300 except for the following items:

**MAXIMUM RATINGS**

Emitter-to-Base Voltage (with collector open) .....	-4 max	volts
---	--------	-------

**CHARACTERISTICS**

Base-to-Emitter Voltage (with collector ma = -40 and base ma = -1) .....	-0.6 max	volt
Collector-Cutoff Current (with collector-to-base volts = -6 and emitter current = 0) .....	-3 max	μa
Total Stored Charge:		
With collector ma = -10 and base ma = -0.4 .....	325 max	pcoul
With collector ma = -40 and base ma = -1.6 .....	800 max	pcoul

*In Common-Base Circuit*

Collector Capacitance (with collector-to-base volts = -6 and emitter open) .....	12 max	pf
--	--------	----

*In Common-Emitter Circuit*

Forward Current-Transfer Ratio:		
With collector-to-emitter volts = -0.3 and collector ma = -10 .....	30 min	
With collector-to-emitter volts = -0.5 and collector ma = -40 .....	40 min	
Gain-Bandwidth Product (with collector-to-emitter volts = -3 and collector ma = -10) .....	35 min	Mc

**TRANSISTOR**

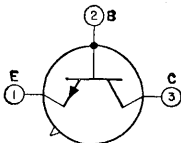

Germanium n-p-n type used in medium-speed switching applications in data-processing equipment. JEDEC No. TO-5 package; outline 6, Outlines Section.

**2N1302**

**MAXIMUM RATINGS**

Collector-to-Base Voltage (with emitter open) .....	25 max	volts
Emitter-to-Base Voltage (with collector open) .....	25 max	volts
Collector Current .....	300 max	ma

Transistor Dissipation:		
At ambient temperatures up to 25°C .....	150 max	mw
At ambient temperatures above 25°C .....	See curve page 80	
Ambient-Temperature Range:		
Operating .....	-65 to 85	°C
Storage .....	-65 to 100	°C
Lead Temperature (for 10 seconds maximum) .....	230 max	°C

**CHARACTERISTICS**

Base-to-Emitter Voltage (with collector ma = 10 and base ma = 0.5) .....	0.15 to 0.4	volt
Collector-to-Emitter Saturation Voltage (with collector ma = 10 and base ma = 0.5) .....	0.2 max	volt
Collector-Cutoff Current (with collector-to-base volts = 25 and emitter current = 0) .....	6 max	µa

*In Common-Base Circuit*

Collector-to-Base Capacitance (with collector-to-base volts = 5 and emitter current = 0) .....	20 max	pf
Forward-Current-Transfer-Ratio Cutoff Frequency (with collector-to-base volts = 5 and emitter ma = 1) .....	3 min	Mc

*In Common-Emitter Circuit*

Forward Current-Transfer Ratio:		
With collector-to-emitter volts = 1 and collector ma = 10 .....	20 min	
With collector-to-emitter volts = 0.35 and collector ma = 200 .....	10 min	

**TRANSISTOR**

**2N1303**

Germanium p-n-p type used in medium-speed switching applications in data-processing equipment. JEDEC No. TO-5 package; outline 6, Outlines Section.

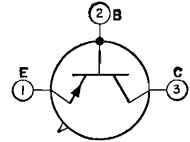

**MAXIMUM RATINGS**

Collector-to-Base Voltage (with emitter open) .....	-30 max	volts
Emitter-to-Base Voltage (with collector open) .....	-25 max	volts
Collector Current .....	-300 max	ma
Transistor Dissipation:		
At ambient temperatures up to 25°C .....	150 max	mw
At ambient temperatures above 25°C .....	See curve page 80	
Ambient-Temperature Range:		
Operating .....	-65 to 85	°C
Storage .....	-65 to 100	°C
Lead Temperature (for 10 seconds maximum) .....	230 max	°C

**CHARACTERISTICS**

Base-to-Emitter Voltage (with collector ma = -10 and base ma = -0.5) .....	-0.15 to -0.4	volt
Collector-to-Emitter Saturation Voltage (with collector ma = -10 and base ma = -0.5) .....	-0.2 max	volt
Collector-Cutoff Current (with collector-to-base volts = -25 and emitter current = 0) .....	-6 max	µa

*In Common-Base Circuit*

Collector-to-Base Capacitance (with collector-to-base volts = -5 and emitter current = 0) .....	20 max	pf
Forward-Current-Transfer-Ratio Cutoff Frequency (with collector-to-base volts = -5 and emitter ma = 1) .....	3 min	Mc

*In Common-Emitter Circuit*

Forward Current-Transfer Ratio:		
With collector-to-emitter volts = -1 and collector ma = -10 .....	20 min	
With collector-to-emitter volts = -0.35 and collector ma = -200 .....	10 min	

**TRANSISTOR**

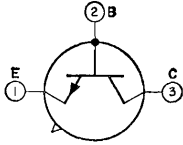

Germanium n-p-n type used in medium-speed switching applications in data-processing equipment. JEDEC No. TO-5 package; outline 6, Outlines Section. This type is identical with type 2N1302 except

**2N1304**

for the following:

**CHARACTERISTICS**

Base-to-Emitter Voltage (with collector ma = 10 and base ma = 0.5) .....	0.15 to 0.35	volt
Collector-to-Emitter Saturation Voltage (with collector ma = 10 and base ma = 0.25) .....	0.2 max	volt

*In Common-Base Circuit*

Forward-Current-Transfer-Ratio Cutoff Frequency (with collector-to-base volts = 5 and emitter ma = 1) .....	5 min	Mc
---	-------	----

*In Common-Emitter Circuit*

Forward Current-Transfer Ratio:		
With collector-to-emitter volts = 1 and collector ma = 10 ..	40 to 200	
With collector-to-emitter volts = 0.35 and collector ma = 200 ..	15 min	

**TRANSISTOR**

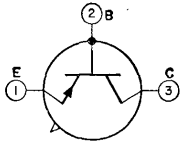

Germanium p-n-p type used in medium-speed switching applications in data-processing equipment. JEDEC No. TO-5 package; outline 6, Outlines Section. This type is identical with type 2N1303 except

**2N1305**

for the following:

**CHARACTERISTICS**

Base-to-Emitter Voltage (with collector ma = -10 and base ma = -0.5) .....	-0.15 to -0.35	volt
Collector-to-Emitter Saturation Voltage (with collector ma = -10 and base ma = -0.25) .....	-0.2 max	volt

*In Common-Base Circuit*

Forward-Current-Transfer-Ratio Cutoff Frequency (with collector-to-base volts = -5 and emitter ma = 1) ....	5 min	Mc
---	-------	----

*In Common-Emitter Circuit*

Forward Current-Transfer Ratio:		
With collector-to-emitter volts = -10 and collector ma = -10 ..	40 to 200	
With collector-to-emitter volts = -0.35 and collector ma = -200 ..	15 min	

**TRANSISTOR**

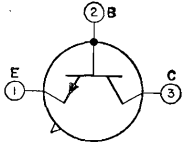

Germanium n-p-n type used in medium-speed switching applications in data-processing equipment. JEDEC No. TO-5 package; outline 6, Outlines Section. This type is identical with type 2N1302 except

**2N1306**

for the following:

**CHARACTERISTICS**

Base-to-Emitter Voltage (with collector ma = 10 and base ma = 0.5) .....	0.15 to 0.35	volt
Collector-to-Emitter Saturation Voltage (with collector ma = 10 and base ma = 0.17) .....	0.2 max	volt

*In Common-Base Circuit*

Forward-Current-Transfer-Ratio Cutoff Frequency  
 (with collector-to-base volts = 5 and emitter ma = 1) ..... 10 min Mc

*In Common-Emitter Circuit*

Forward Current-Transfer Ratio:  
 With collector-to-emitter volts = 1 and collector ma = 10 .... 60 to 300  
 With collector-to-emitter volts = 0.35 and collector ma = 200 . 20 min

**TRANSISTOR**

**2N1307**

Germanium p-n-p type used in medium-speed switching applications in data-processing equipment. JEDEC No. TO-5 package; outline 6, Outlines Section. This type is identical with type 2N1303 except

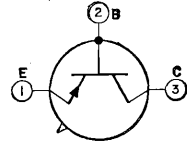

for the following:

**CHARACTERISTICS**

Base-to-Emitter Voltage (with collector ma = -10 and base ma = -0.5) ..... -0.15 to -0.35 volt  
 Collector-to-Emitter Saturation Voltage (with collector ma = -10 and base ma = -0.17) ..... -0.2 max volt

*In Common-Base Circuit*

Forward-Current-Transfer-Ratio Cutoff Frequency  
 (with collector-to-base volts = -5 and emitter ma = 1) .... 10 min Mc

*In Common-Emitter Circuit*

Forward Current-Transfer Ratio:  
 With collector-to-emitter volts = -1 and collector ma = -10 .... 60 to 300  
 With collector-to-emitter volts = -0.35 and collector ma = -200 20 min

**TRANSISTOR**

**2N1308**

Germanium n-p-n type used in medium-speed switching applications in data-processing equipment. JEDEC No. TO-5 package; outline 6, Outlines Section. This type is identical with type 2N1302 except

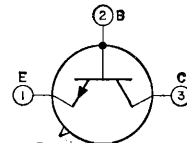

for the following:

**CHARACTERISTICS**

Base-to-Emitter Voltage (with collector ma = 10 and base ma = 0.5) ..... 0.15 to 0.35 volt  
 Collector-to-Emitter Saturation Voltage (with collector ma = 10 and base ma = 0.13) ..... 0.2 max volt

*In Common-Base Circuit*

Forward-Current-Transfer-Ratio Cutoff Frequency  
 (with collector-to-base volts = 5 and emitter ma = 1) ..... 15 min Mc

*In Common-Emitter Circuit*

Forward Current-Transfer Ratio:  
 With collector-to-emitter volts = 1 and collector ma = 10 .... 80 min  
 With collector-to-emitter volts = 0.35 and collector ma = 200 . 20 min

**TRANSISTOR**

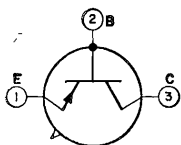

Germanium p-n-p type used in medium-speed switching applications in data-processing equipment. JEDEC No. TO-5 package; outline 6, Outlines Section. This type is identical with type 2N1303 except

**2N1309**

for the following:

**CHARACTERISTICS**

Base-to-Emitter Voltage (with collector ma = -10 and base ma = -0.5) .....	-0.15 to -0.35	volt
Collector-to-Emitter Saturation Voltage (with collector ma = -10 and base ma = -0.13) .....	-0.2 max	volt

*In Common-Base Circuit*

Forward-Current-Transfer-Ratio Cutoff Frequency (with collector-to-base volts = -5 and emitter ma = 1) ....	15 min	Mc
---	--------	----

*In Common-Emitter Circuit*

Forward Current-Transfer Ratio:		
With collector-to-emitter volts = -1 and collector ma = -10 ...	80 min	
With collector-to-emitter volts = -0.35 and collector ma = -200	20 min	

**TRANSISTOR**

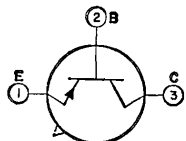

Germanium p-n-p bidirectional type used in medium-speed switching circuits in data-processing equipment. This type is designed so that the emitter can also function as a collector and the collector can

**2N1319**

also function as an emitter. It is especially useful in bidirectional switching, core-driver, and ac-signal relay circuits. JEDEC No. TO-5 package; outline 6, Outlines Section.

**MAXIMUM RATINGS**

Collector-to-Base Voltage (with emitter open) .....	-20 max	volt
Emitter-to-Base Voltage (with collector open) .....	-20 max	volt
Collector-to-Emitter Voltage (with base-to-emitter volts = 1) ..	-20 max	volt
Collector Current .....	±400 max	ma
Emitter Current .....	±400 max	ma
Transistor Dissipation:		
At ambient temperatures up to 25°C .....	120 max	mw
At ambient temperature of 55°C .....	35 max	mw
At ambient temperature of 71°C .....	10 max	mw
Ambient-Temperature Range:		
Operating .....	-65 to 71	°C
Storage .....	-65 to 85	°C

**CHARACTERISTICS**

Base-to-Emitter Voltage (with collector ma = -400 and base ma = -26.7) .....	-1.5 max	volt
Collector-to-Emitter Saturation Voltage (with collector ma = -400 and base ma = -26.7) .....	-0.3 max	volt
Collector-Cutoff Current (with collector-to-base volts = -12 and emitter current = 0) .....	-6 max	µa

*In Common-Base Circuit*

Forward-Current-Transfer-Ratio Cutoff Frequency (with collector-to-base volts = -6 and emitter ma = 1) ....	3 min	Mc
Collector-to-Base Capacitance (with collector-to-base volts = -6 and emitter current = 0) .....	30 max	pf

*In Common-Emitter Circuit*

Forward Current-Transfer Ratio (with collector-to-emitter volts = -0.3 and collector ma = -400) .....	15 min	
---	--------	--

**POWER TRANSISTOR**

**2N1358**

Germanium p-n-p type used in a wide variety of switching and amplifier applications in industrial and military equipment requiring transistors having high voltage, current, and dissipation values. It is used in

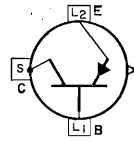

power-switching, voltage- and current-regulating, dc-to-dc converter, inverter, power-supply, and relay- and solenoid-actuating circuits; and in low-frequency oscillator and audio-amplifier service. This type is designed to provide satisfactory performance under extreme environmental conditions of temperature, moisture, and altitude; it is stud-mounted to provide positive heat-sink contact, and has a cold-weld seal to insure reliable performance under severe environmental conditions. JEDEC No. TO-36 package; outline 14, Outlines Section. This type is identical with type 2N174 except for the following items:

**CHARACTERISTICS**

Collector-to-Emitter Breakdown Voltage:

With base short-circuited to emitter and collector amperes = -0.3	-70 min	volts
With base open and collector amperes = -0.3	-40 min	volts
<b>Base-to-Emitter Voltage:</b>		
With collector-to-emitter volts = -2 and collector amperes = -5	-0.65	volt
With collector-to-base volts = -2 and collector amperes = -1.2 and emitter current = 0	-0.35	volt
Emitter-to-Base Voltage (with collector-to-base volts = -80 and emitter current = 0)	-0.15	volt
Emitter-Cutoff Current (with emitter-to-base volts = -60 and collector current = 0)	-1	ma
Collector-Cutoff Current (with collector-to-base volts = -2 and emitter current = 0)	-100	µa

**In Common-Base Circuit**

Small-Signal Forward-Current-Transfer-Ratio Cutoff Frequency (with collector-to-base volts = -12 and collector amperes = -1)	100	kc
--	-----	----

**In Common-Emitter Circuit**

<b>DC Forward Current-Transfer Ratio:</b>		
With collector-to-emitter volts = -2 and collector amperes = -1.2	55	
With collector-to-emitter volts = -2 and collector amperes = -5	35	

**TRANSISTOR**

**2N1384**

Germanium p-n-p type used in high-speed switching circuits in electronic computers. JEDEC No. TO-11 package; outline 10, Outlines Section.

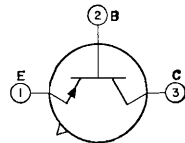

**MAXIMUM RATINGS**

Collector-to-Base Voltage (with emitter open)	-30 max	volts
Collector-to-Emitter Voltage (with base open)	-30 max	volts
Emitter-to-Base Voltage (with collector open)	-1 max	volt
Collector Current	-500 max	ma
Emitter Current	500 max	ma
<b>Transistor Dissipation:</b>		
At ambient temperatures up to 25°C	240 max	mw
At ambient temperatures above 25°C	See curve	page 80
<b>Ambient-Temperature Range:</b>		
Operating and storage	-65 to 85	°C

**CHARACTERISTICS**

Base-to-Emitter Voltage (with collector ma = -200 and base ma = -10)	-0.9 max	volt
Collector-Cutoff Current (with collector-to-base volts = -3 and emitter current = 0)	-8 max	µa
Stored Base Charge (with collector ma = -10 and base ma = -1)	800 max	pcol



In Common-Emitter Circuit

Forward Current-Transfer Ratio (with collector-to-emitter volts = -0.5 and collector ma = -200) .....	20 min	
Gain-Bandwidth Product (with collector-to-emitter volts = -3 and collector ma = -10) .....	20 min	Mc

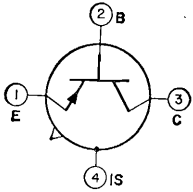

TRANSISTOR

2N1395

Germanium p-n-p type used in rf and if amplifier circuits; oscillator, mixer, and converter circuits; and low-level video-amplifier circuits in industrial and military equipment. It is used in the design of rf circuits

having high input-circuit efficiency, excellent operating stability, good automatic-gain-control capabilities over a wide range of input-signal levels, and good signal-to-noise ratio. The drift-field construction provides low base resistance and collector-transition capacitance, and improves performance at high frequencies. A fourth lead internally connected to the metal case provides integral shielding which minimizes interlead capacitance and coupling to adjacent circuit components. JEDEC No. TO-33 package; outline 13, Outlines Section. This type is electrically identical with type 2N274 except for the collector-characteristic curves shown below and a higher common-emitter small-signal forward current-transfer ratio of 90.

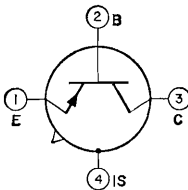
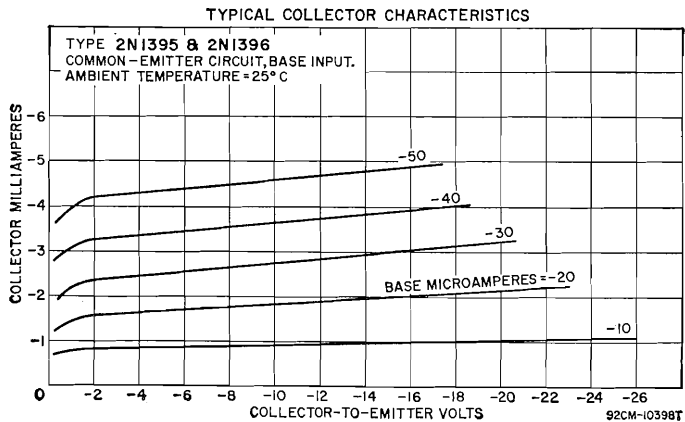

TRANSISTOR

2N1396

Germanium p-n-p type used in rf and if amplifier circuits; oscillator, mixer, and converter circuits; and low-level video-amplifier circuits in industrial and military equipment. It is used in the design of rf circuits

having high input-circuit efficiency, excellent operating stability, good automatic-gain-control capabilities over a wide range of input-signal levels, and good signal-to-noise ratio. The drift-field construction provides low base re-

sistance and collector-transition capacitance, and improves performance at high frequencies. A fourth lead internally connected to the metal case provides integral shielding which minimizes interlead capacitance and coupling to adjacent circuit components. JEDEC No. TO-33 package; outline 13, Outlines Section. This type is electrically identical with type 2N384 except for the collector-characteristic curves, which are the same as for type 2N1395, and a higher common-emitter small-signal forward current-transfer ratio of 90.

**TRANSISTOR**

**2N1397**

Germanium p-n-p type used in rf and if amplifier circuits; oscillator, mixer, and converter circuits; and low-level video-amplifier circuits in industrial and military equipment. It is used in the design of rf circuits

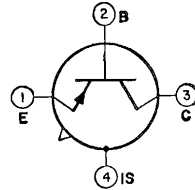

having high input-circuit efficiency, excellent operating stability, good automatic-gain-control capabilities over a wide range of input-signal levels, and good signal-to-noise ratio. The drift-field construction provides low base resistance and collector-transition capacitance, and improves performance at high frequencies. A fourth lead internally connected to the metal case provides integral shielding which minimizes interlead capacitance and coupling to adjacent circuit components. JEDEC No. TO-33 package; outline 13, Outlines Section. This type is electrically identical with type 2N1023 except for the collector-characteristic curves, which are the same as for type 2N1395, and a higher common-emitter small-signal forward current-transfer ratio of 90.

**POWER TRANSISTOR**

**2N1412**

Germanium p-n-p type used in a wide variety of switching and amplifier applications in industrial and military equipment requiring transistors having high voltage, current, and dissipation values. It is used in

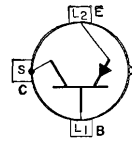

power-switching, voltage- and current-regulating, dc-to-dc converter, inverter, power-supply, and relay- and solenoid-actuating circuits; and in low-frequency oscillator and audio-amplifier service. This type is designed to provide satisfactory performance under extreme environmental conditions of temperature, moisture, and altitude; it is stud-mounted to provide positive heat-sink contact, and has a cold-weld seal to insure reliable performance under severe environmental conditions. JEDEC No. TO-36 package; outline 14, Outlines Section. This type is identical with type 2N174 except for the collector-characteristics curves, which are the same as for type 2N1100, and the following items:

**MAXIMUM RATINGS**

Collector-to-Base Voltage (with emitter-to-base volts = -1.5) ..	-100 max	volts
Emitter-to-Base Voltage (with collector open) .....	-60 max	volts

**CHARACTERISTICS**

Collector-to-Emitter Breakdown Voltage (with base short-circuited to emitter and collector amperes = -0.3) .....	-80 min	volts
Emitter-to-Base Voltage (with collector-to-base volts = -80 and emitter current = 0) .....	-1 max	volt
Collector-to-Emitter Reach-Through Voltage .....	-100 min	volts
Collector-Cutoff Current (with collector-to-base volts = -100 and emitter current = 0) .....	-2	ma

**2N1425**

See List of Discontinued Transistors at end of Technical Data Section for abbreviated data.

See List of Discontinued Transistors at end of Technical Data Section for abbreviated data.

**2N1426**

See List of Discontinued Transistors at end of Technical Data Section for abbreviated data.

**2N1450**

**POWER TRANSISTOR**

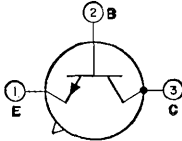

Silicon n-p-n type used in a wide variety of medium-power switching and amplifier applications in industrial and military equipment. It is used in power switching, dc-to-dc converter, inverter, chopper, sole-

**2N1479**

noid and relay control circuits; in oscillator, regulator, and pulse-amplifier circuits; and as a class A or class B push-pull audio and servo amplifier. It features low saturation resistance, high current and power dissipation, high beta at high current, and excellent high-temperature performance. JEDEC No. TO-5 package; outline 6, Outlines Section. This type is identical with type 2N1482 except for the following:

**MAXIMUM RATINGS**

Collector-to-Base Voltage (with emitter open) .....	60 max	volts
Collector-to-Emitter Voltage:		
With emitter-to-base volts = 1.5 .....	60 max	volts
With base open .....	40 max	volts

**CHARACTERISTICS**

Collector-to-Emitter Breakdown Voltage (with emitter-to-base volts = 1.5 and collector ma = 0.25) .....	60 min	volts
Collector-to-Emitter Sustaining Voltage (with collector ma = 50 and base current = 0) .....	40 min	volts

*In Common-Emitter Circuit*

DC Forward Current-Transfer Ratio (with collector-to-emitter volts = 4 and collector ma = 400) ..	20 to 60	
DC Collector-to-Emitter Saturation Resistance (with collector ma = 200 and base ma = 20) .....	7 max	ohms

**POWER TRANSISTOR**

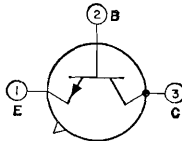

Silicon n-p-n type used in a wide variety of medium-power switching and amplifier applications in industrial and military equipment. It is used in power switching, dc-to-dc converter, inverter, chopper, sole-

**2N1480**

noid and relay control circuits; in oscillator, regulator, and pulse-amplifier circuits, and as a class A or class B push-pull audio and servo amplifier. It features low saturation resistance, high current and power dissipation, high beta at high current, and excellent high-temperature performance. JEDEC No. TO-5 package; outline 6, Outlines Section. This type is identical with type 2N1482 except for the following items:

**CHARACTERISTICS**

*In Common-Emitter Circuit*

DC Forward Current-Transfer Ratio (with collector-to-emitter volts = 4 and collector ma = 200) .....	20 to 60	
DC Collector-to-Emitter Saturation Resistance (with collector ma = 200 and base ma = 20) .....	7 max	ohms

**POWER TRANSISTOR**

**2N1481**

Silicon n-p-n type used in a wide variety of medium-power switching and amplifier applications in industrial and military equipment. It is used in power switching, dc-to-dc converter, inverter, chopper, sole-

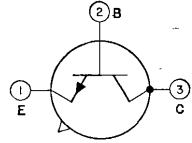

noid and relay control circuits; in oscillator, regulator, and pulse-amplifier circuits; and as a class A or class B push-pull audio and servo amplifier. It features low saturation resistance, high current and power dissipation, high beta at high current, and excellent high-temperature performance. JEDEC No. TO-5 package; outline 6, Outlines Section. This type is identical with type 2N1482 except for the following items:

**MAXIMUM RATINGS**

Collector-to-Base Voltage (with emitter open) .....	60 max	volts
Collector-to-Emitter Voltage:		
With emitter-to-base volts = 1.5 .....	60 max	volts
With base open .....	40 max	volts

**CHARACTERISTICS**

Collector-to-Emitter Breakdown Voltage (with emitter-to-base volts = 1.5 and collector ma = 0.25) ..	60 min	volts
Collector-to-Emitter Sustaining Voltage (with collector ma = 50 and base current = 0) .....	40 min	volts

**POWER TRANSISTOR**

**2N1482**

Silicon n-p-n type used in a wide variety of medium-power switching and amplifier applications in industrial and military equipment. It is used in power switching, dc-to-dc converter, inverter, chopper, sole-

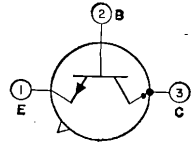

noid and relay control circuits; in oscillator, regulator, and pulse-amplifier circuits; and as a class A or class B push-pull audio and servo amplifier. It features low saturation resistance, high current and power dissipation, high beta at high current, and excellent high-temperature performance. JEDEC No. TO-5 package; outline 6, Outlines Section.

**MAXIMUM RATINGS**

Collector-to-Base Voltage (with emitter open) .....	100 max	volts
Collector-to-Emitter Voltage:		
With emitter-to-base volts = 1.5 .....	100 max	volts
With base open .....	55 max	volts
Emitter-to-Base Voltage (with collector open) .....	12 max	volts
Collector Current .....	1.5 max	amperes
Emitter Current .....	-1.75 max	amperes
Base Current .....	1 max	ampere
Transistor Dissipation:		
At case temperatures up to 25°C .....	5 max	watts
At case temperatures above 25°C .....	See curve	page 80
Temperature Range:		
Operating (junction) and Storage .....	-65 to 200	°C

**CHARACTERISTICS**

Collector-to-Emitter Breakdown Voltage (with emitter-to-base volts = 1.5 and collector ma = 0.25) .....	100 min	volts
Collector-to-Emitter Sustaining Voltage (with collector ma = 50 and base current = 0) .....	55 min	volts
Base-to-Emitter Voltage (with collector-to-emitter volts = 4 and collector ma = 200) .....	3 max	volts
Collector-Cutoff Current (with collector-to-base volts = 30 and emitter current = 0) .....	10 max	μa
Emitter-Cutoff Current (with emitter-to-base volts = 12 and collector current = 0) .....	10 max	μa

Thermal Resistance:	
Junction-to-case .....	35 max °C/watt
Junction-to-ambient .....	200 max °C/watt
Thermal Time Constant .....	10 msec

**In Common-Base Circuit**

Small-Signal Forward-Current-Transfer-Ratio Cutoff Frequency (with collector-to-base volts = 28 and collector ma = 5) .....	1.5	Mc
Collector-to-Base Capacitance (with collector-to-base volts = 40 and emitter current = 0) .....	150	pf

**In Common-Emitter Circuit**

DC Forward Current-Transfer Ratio (with collector-to-emitter volts = 4 and collector ma = 400) .....	35 to 100
Small-Signal Forward Current-Transfer Ratio (with collector-to- emitter volts = 4 and collector ma = 5) .....	50
DC Collector-to-Emitter Saturation Resistance (with collector ma = 200 and base ma = 10) .....	7 max ohms

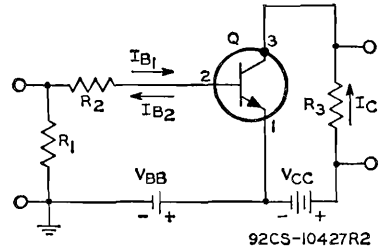
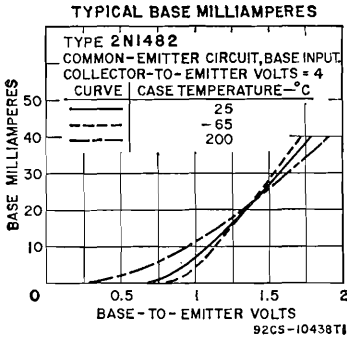

- $V_{BB} = 8.5$  volts
- $V_{CC} = 12$  volts
- $R_1 = 50$  ohms, 1 watt
- $R_2 = 700$  ohms, 1 watt
- $R_3 = 59$  ohms, 2 watts

**TYPICAL OPERATION IN POWER-SWITCHING CIRCUIT ABOVE**

DC Collector Supply Voltage ( $V_{CC}$ ) .....	12	volts
DC Base Supply Voltage ( $V_{BB}$ ) .....	-8.5	volts
Generator Resistance .....	50	ohms
On DC Collector Current ( $I_C$ ) .....	200	ma
Turn-On DC Base Current ( $I_{B1}$ ) .....	20	ma
Turn-Off DC Base Current ( $I_{B2}$ ) .....	-8.5	ma
Switching Time:		
Delay time ( $t_d$ ) .....	0.2	$\mu$ sec
Rise time ( $t_r$ ) .....	1	$\mu$ sec
Storage time ( $t_s$ ) .....	0.6	$\mu$ sec
Fall time ( $t_f$ ) .....	1	$\mu$ sec

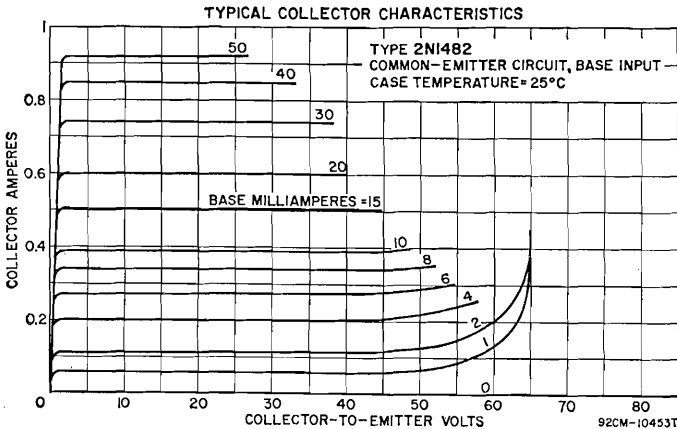

POWER TRANSISTOR

2N1483

Silicon n-p-n type used in a wide variety of intermediate-power switching and amplifier applications in industrial and military equipment. It is used in power switching, dc-to-dc converter, inverter, chopper, sole-

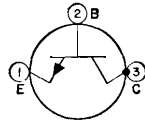

noid and relay control circuits; in oscillator, regulator, and pulse-amplifier circuits; and as a class A or class B push-pull audio and servo amplifier. It features low saturation resistance, high current and power dissipation, high beta at high current, and excellent high-temperature performance. JEDEC No. TO-8 package; outline 8, Outlines Section. This type is identical with type 2N1486 except for the following:

MAXIMUM RATINGS

Collector-to-Base Voltage (with emitter open) .....	60 max	volts
Collector-to-Emitter Voltage:		
With emitter-to-base volts = 1.5 .....	60 max	volts
With base open .....	40 max	volts

CHARACTERISTICS

Collector-to-Emitter Breakdown Voltage (with emitter-to-base volts = 1.5 and collector ma = 0.25) .....	60 min	volts
Collector-to-Emitter Sustaining Voltage (with collector ma = 100 and base current = 0) .....	40 min	volts

In Common-Emitter Circuit

DC Forward Current-Transfer Ratio (with collector-to-emitter volts = 4 and collector ma = 750) .....	20 to 60	
DC Collector-to-Emitter Saturation Resistance (with collector ma = 750 and base ma = 75) .....	2.67 max	ohms

POWER TRANSISTOR

2N1484

Silicon n-p-n type used in a wide variety of intermediate-power switching and amplifier applications in industrial and military equipment. It is used in power switching, dc-to-dc converter, inverter, chopper, sole-

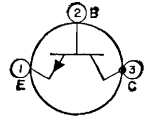

noid and relay control circuits; in oscillator, regulator, and pulse-amplifier circuits; and as a class A or class B push-pull audio and servo amplifier. It features low saturation resistance, high current and power dissipation, high beta at high current, and excellent high-temperature performance. JEDEC No. TO-8 package; outline 8, Outlines Section. This type is identical with type 2N1486 except for the following:

CHARACTERISTICS

In Common-Emitter Circuit

DC Forward Current-Transfer Ratio (with collector-to-emitter volts = 4 and collector ma = 750) .....	20 to 60	
DC Collector-to-Emitter Saturation Resistance (with collector ma = 750 and base ma = 75) .....	2.67 max	ohms

**POWER TRANSISTOR**

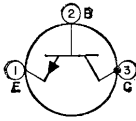

Silicon n-p-n type used in a wide variety of intermediate-power switching and amplifier applications in industrial and military equipment. It is used in power switching, dc-to-dc converter, inverter, chopper, sole-

**2N1485**

noid and relay control circuits; in oscillator, regulator, and pulse-amplifier circuits; and as a class A or class B push-pull audio and servo amplifier. It features low saturation resistance, high current and power dissipation, high beta at high current, and excellent high-temperature performance. JEDEC No. TO-8 package; outline 8, Outlines Section. This type is identical with type 2N1486 except for the following:

**MAXIMUM RATINGS**

Collector-to-Base Voltage (with emitter open) .....	60 max	volts
Collector-to-Emitter Voltage:		
With emitter-to-base volts = 1.5 .....	60 max	volts
With base open .....	40 max	volts

**CHARACTERISTICS**

Collector-to-Emitter Breakdown Voltage (with emitter-to-base volts = 1.5 and collector ma = 0.25) .....	60 min	volts
Collector-to-Emitter Sustaining Voltage (with collector ma = 100 and base current = 0) .....	40 min	volts

**POWER TRANSISTOR**

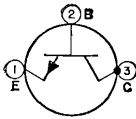

Silicon n-p-n type used in a wide variety of intermediate-power switching and amplifier applications in industrial and military equipment. It is used in power switching, dc-to-dc converter, inverter, chopper, sole-

**2N1486**

noid and relay control circuits; in oscillator, regulator, and pulse-amplifier circuits; and as a class A or class B push-pull audio and servo amplifier. It features low saturation resistance, high current and power dissipation, high beta at high current, and excellent high-temperature performance. JEDEC No. TO-8 package; outline 8, Outlines Section.

**MAXIMUM RATINGS**

Collector-to-Base Voltage (with emitter open) .....	100 max	volts
Collector-to-Emitter Voltage:		
With emitter-to-base volts = 1.5 .....	100 max	volts
With base open .....	55 max	volts
Emitter-to-Base Voltage (with collector open) .....	12 max	volts
Collector Current .....	3 max	amperes
Emitter Current .....	-3.5 max	amperes
Base Current .....	1.5 max	amperes
Transistor Dissipation:		
At case temperatures up to 25°C .....	25 max	watts
At case temperatures above 25°C .....	See curve page 80	
Temperature Range:		
Operating (junction) and storage .....	-65 to 200	°C

**CHARACTERISTICS**

Collector-to-Emitter Breakdown Voltage (with emitter-to-base volts = 1.5 and collector ma = 0.25) .....	100 min	volts
Collector-to-Emitter Sustaining Voltage (with collector ma = 100 and base current = 0) .....	55 min	volts
Base-to-Emitter Voltage (with collector-to-emitter volts = 4 and collector ma = 750) .....	3.5 max	volts
Collector-Cutoff Current (with collector-to-base volts = 30 and emitter current = 0) .....	15 max	μa
Emitter-Cutoff Current (with emitter-to-base volts = 12 and collector current = 0) .....	15 max	μa

Thermal Resistance:		
Junction-to-case .....		7 max °C/watt
Junction-to-ambient .....		100 max °C/watt
Thermal Time Constant .....		10 msec

**In Common-Base Circuit**

Small-Signal Forward-Current-Transfer-Ratio Cutoff Frequency (with collector-to-base volts = 28 and collector ma = 5) ....	1.25	Mc
Collector-to-Base Capacitance (with collector-to-base volts = 40 and emitter current = 0) .....	175	pf

**In Common-Emitter Circuit**

DC Forward Current-Transfer Ratio (with collector-to-emitter volts = 4 and collector ma = 750) .....	35 to 100	
Collector-to-Emitter Saturation Resistance (with collector ma = 750 and base ma = 40) .....	1 max	ohm

**TYPICAL BASE CHARACTERISTICS**

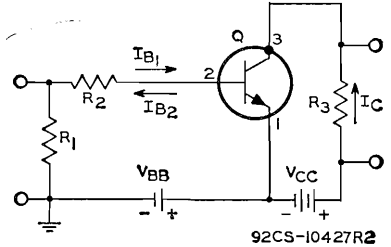
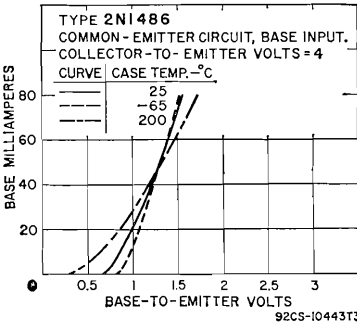

- $V_{BB}$  = 8.5 volts
- $V_{CC}$  = 12 volts
- $R_1$  = 50 ohms, 1 watt
- $R_2$  = 220 ohms, 1 watt
- $R_3$  = 15.9 ohms, 2 watts

**TYPICAL OPERATION IN POWER-SWITCHING CIRCUIT ABOVE**

DC Collector Supply Voltage ( $V_{CC}$ ) .....	12	volts
DC Base Supply Voltage ( $V_{BB}$ ) .....	-8.5	volts
Generator Resistance .....	50	ohms
On DC Collector Current ( $I_C$ ) .....	750	ma
Turn-On DC Base Current ( $I_{B1}$ ) .....	65	ma
Turn-Off DC Base Current ( $I_{B2}$ ) .....	-35	ma
Switching Time:		
Delay time ( $t_d$ ) .....	0.2	$\mu$ sec
Rise time ( $t_r$ ) .....	1	$\mu$ sec
Storage time ( $t_s$ ) .....	0.8	$\mu$ sec
Fall time ( $t_f$ ) .....	1.1	$\mu$ sec

**TYPICAL COLLECTOR CHARACTERISTICS**

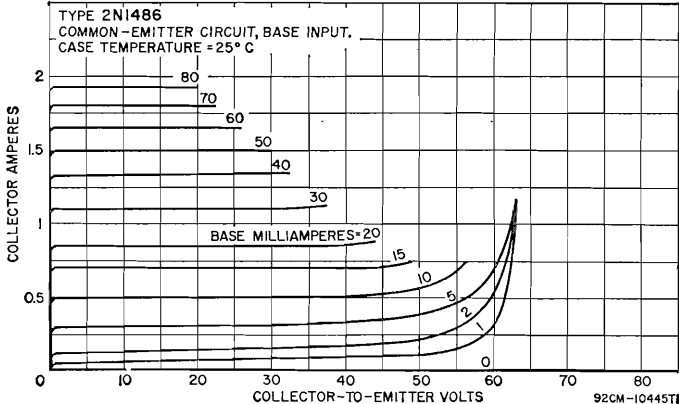



**POWER TRANSISTOR**

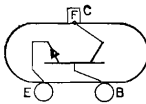

**2N1487**

Silicon n-p-n type used in a wide variety of high-power switching and amplifier applications in industrial and military equipment. It is used in power switching, dc-to-dc converter, inverter, chopper, solenoid

and relay control circuits; in oscillator, regulator, and pulse-amplifier circuits; and as a class A or class B push-pull audio and servo amplifier. It features low saturation resistance, high current and power dissipation, high beta at high current, and excellent high-temperature performance. Package is similar to JEDEC No. TO-3; outline 23, Outlines Section. This type is identical with type 2N1490 except for the following:

**MAXIMUM RATINGS**

Collector-to-Base Voltage (with emitter open) .....	60 max	volts
Collector-to-Emitter Voltage: With emitter-to-base volts = 1.5 .....	60 max	volts
With base open .....	40 max	volts

**CHARACTERISTICS**

Collector-to-Emitter Breakdown Voltage (with emitter-to-base volts = 1.5 and collector ma = 0.5) .....	60 min	volts
Collector-to-Emitter Sustaining Voltage (with collector ma = 100 and base current = 0) .....	40 min	volts

*In Common-Emitter Circuit*

DC Forward Current-Transfer Ratio (with collector-to-emitter volts = 4 and collector amperes = 1.5) .....	15 to 45	
DC Collector-to-Emitter Saturation Resistance (with collector amperes = 1.5 and base ma = 300) .....	2 max	ohms

**POWER TRANSISTOR**

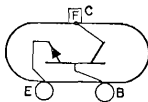

**2N1488**

Silicon n-p-n type used in a wide variety of high-power switching and amplifier applications in industrial and military equipment. It is used in power switching, dc-to-dc converter, inverter, chopper, solenoid

and relay control circuits; in oscillator, regulator, and pulse-amplifier circuits; and as a class A or class B push-pull audio and servo amplifier. It features low saturation resistance, high current and power dissipation, high beta at high current, and excellent high-temperature performance. Package is similar to JEDEC No. TO-3; outline 23, Outlines Section. This type is identical with type 2N1490 except for the following:

**CHARACTERISTICS**

*In Common-Emitter Circuit*

DC Forward Current-Transfer Ratio (with collector-to-emitter volts = 4 and collector amperes = 1.5) .....	15 to 45	
DC Collector-to-Emitter Saturation Resistance (with collector amperes = 1.5 and base ma = 300) .....	2 max	ohms

**POWER TRANSISTOR**

**2N1489**

Silicon n-p-n type used in a wide variety of high-power switching and amplifier applications in industrial and military equipment. It is used in power switching, dc-to-dc converter, inverter, chopper, solenoid

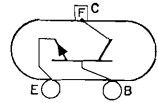

and relay control circuits; in oscillator, regulator, and pulse-amplifier circuits; and as a class A or class B push-pull audio and servo amplifier. It features low saturation resistance, high current and power dissipation, high beta at high current, and excellent high-temperature performance. Package is similar to JEDEC No. TO-3; outline 23, Outlines Section. This type is identical with type 2N1490 except for the following:

**MAXIMUM RATINGS**

Collector-to-Base Voltage (with emitter open) .....	60 max	volts
Collector-to-Emitter Voltage:		
With emitter-to-base volts = 1.5 .....	60 max	volts
With base open .....	40 max	volts

**CHARACTERISTICS**

Collector-to-Emitter Breakdown Voltage (with emitter-to-base volts = 1.5 and collector $i_a = 0.5$ ) .....	60 min	volts
Collector-to-Emitter Sustaining Voltage (with collector $i_a = 100$ and base current = 0) .....	40 min	volts

**POWER TRANSISTOR**

**2N1490**

Silicon n-p-n type used in a wide variety of high-power switching and amplifier applications in industrial and military equipment. It is used in power switching, dc-to-dc converter, inverter, chopper, solenoid

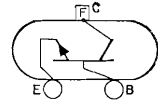

and relay control circuits; in oscillator, regulator, and pulse-amplifier circuits; and as a class A or class B push-pull audio and servo amplifier. It features low saturation resistance, high current and power dissipation, high beta at high current, and excellent high-temperature performance. Package is similar to JEDEC No. TO-3; outline 23, Outlines Section.

**MAXIMUM RATINGS**

Collector-to-Base Voltage (with emitter open) .....	100 max	volts
Collector-to-Emitter Voltage:		
With emitter-to-base volts = 1.5 .....	100 max	volts
With base open .....	55 max	volts
Emitter-to-Base Voltage (with collector open) .....	10 max	volts
Collector Current .....	6 max	amperes
Emitter Current .....	-8 max	amperes
Base Current .....	3 max	amperes
Transistor Dissipation:		
At mounting-flange temperatures up to 25°C .....	75 max	watts
At mounting-flange temperatures above 25°C .....	See curve	page 80
Temperature Range:		
Operating (junction) and storage .....	-65 to 200	°C

**CHARACTERISTICS**

Collector-to-Emitter Breakdown Voltage (with emitter-to-base volts = 1.5 and collector $i_a = 0.5$ ) .....	100 min	volts
Collector-to-Emitter Sustaining Voltage (with collector $i_a = 100$ and base current = 0) .....	55 min	volts
Base-to-Emitter Voltage (with collector-to-emitter volts = 4 and collector amperes = 1.5) .....	3.5 max	volts
Collector-Cutoff Current (with collector-to-base volts = 30 and emitter current = 0) .....	25 max	$\mu$ a
Emitter-Cutoff Current (with emitter-to-base volts = 10 and collector current = 0) .....	25 max	$\mu$ a
Thermal Resistance:		
Junction-to-mounting-flange .....	23.3 max	°C/watt
Thermal Time Constant .....	12	msec

In Common-Base Circuit

Small-Signal Forward-Current-Transfer-Ratio Cutoff Frequency (with collector-to-base volts = 12 and collector ma = 100)	1	Mc
Collector-to-Base Capacitance (with collector-to-base volts = 40 and emitter current = 0)	200	pf

In Common-Emitter Circuit

DC Forward Current-Transfer Ratio (with collector-to-emitter volts = 4 and collector amperes = 1.5)	25 to 75	
Collector-to-Emitter Saturation Resistance (with collector amperes = 1.5 and base ma = 300)	0.67 max	ohm

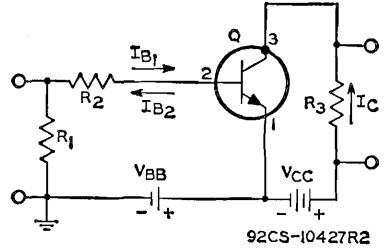
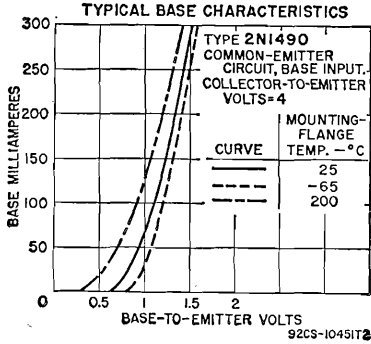

- $V_{BB} = 8.5$  volts
- $V_{CC} = 12$  volts
- $R_1 = 50$  ohms, 1 watt
- $R_2 = 30$  ohms, 1 watt
- $R_3 = 7.8$  ohms, 2 watts

TYPICAL OPERATION IN POWER-SWITCHING CIRCUIT ABOVE

DC Collector Supply Voltage ( $V_{CC}$ )	12	volts
DC Base Supply Voltage ( $V_{BB}$ )	-8.5	volts
Generator Resistance	50	ohms
On DC Collector Current ( $I_C$ )	1.5	ma
Turn-On DC Base Current ( $I_{B1}$ )	300	ma
Turn-Off DC Base Current ( $I_{B2}$ )	-150	ma
Switching Time:		
Delay time ( $t_d$ )	0.2	$\mu$ sec
Rise time ( $t_r$ )	1	$\mu$ sec
Storage time ( $t_s$ )	1	$\mu$ sec
Fall time ( $t_f$ )	1.2	$\mu$ sec

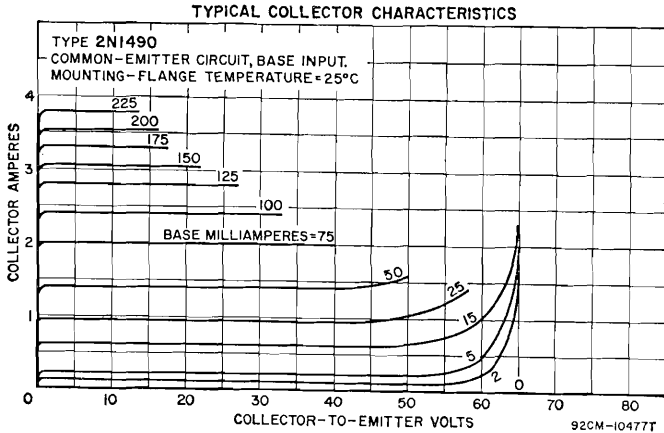

## TRANSISTOR

## 2N1491

Silicon n-p-n type used in a wide variety of high-frequency and vhf applications in industrial and military equipment. It is used in large-signal power-amplifier, video-amplifier, oscillator, and mixer circuits over a wide temperature range.

This type can also be used in switching service in circuits requiring transistors having high voltage, current, and dissipation values. JEDEC No. TO-39 package; outline 32, Outlines Section. This type is identical with type 2N1493 except for the following items:

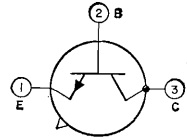

## MAXIMUM RATINGS

Collector-to-Base Voltage (with emitter open) .....	30 max	volts
Collector-to-Emitter Voltage (with emitter-to-base volts = 0.5) .....	30 max	volts
Emitter-to-Base Voltage (with collector open) .....	1 max	volt

## CHARACTERISTICS

Collector-to-Base Breakdown Voltage (with collector $ma = 0.1$ and emitter current = 0) .....	30 min	volts
---	--------	-------

*In Common-Base Circuit*

Small-Signal Forward-Current-Transfer-Ratio Cutoff Frequency (with collector-to-base volts = 30 and collector $ma = 15$ ) ....	250	Mc
--	-----	----

*In Common-Emitter Circuit*

Power Gain at 70 Mc (with collector-to-base volts = 20, emitter $ma = -15$ , and power output = 10 mw) .....	15	db
--	----	----

## TRANSISTOR

## 2N1492

Silicon n-p-n type used in a wide variety of high-frequency and vhf applications in industrial and military equipment. It is used in large-signal power-amplifier, video-amplifier, oscillator, and mixer circuits over a wide temperature range.

This type can also be used in switching service in circuits requiring transistors having high voltage, current, and dissipation values. JEDEC No. TO-39 package; outline 32, Outlines Section. This type is identical with type 2N1493 except for the following items:

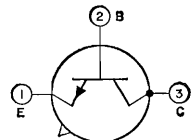

## MAXIMUM RATINGS

Collector-to-Base Voltage (with emitter open) .....	60 max	volts
Collector-to-Emitter Voltage (with emitter-to-base volts = 0.5) .....	60 max	volts
Emitter-to-Base Voltage (with collector open) .....	2 max	volts

## CHARACTERISTICS

Collector-to-Base Breakdown Voltage (with collector $ma = 0.1$ and emitter current = 0) .....	60 min	volts
---	--------	-------

*In Common-Base Circuit*

Small-Signal Forward-Current-Transfer-Ratio Cutoff Frequency (with collector-to-base volts = 30 and collector $ma = 15$ ) ....	275	Mc
--	-----	----

*In Common-Emitter Circuit*

Power Gain at 70 Mc (with collector-to-base volts = 30, emitter $ma = -15$ , and power output = 100 mw) .....	15	db
---	----	----

**TRANSISTOR**

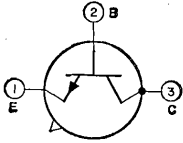

Silicon n-p-n type used in a wide variety of high-frequency and vhf applications in industrial and military equipment. It is used in large-signal power-amplifier, video-amplifier, oscillator, and mixer circuits over a wide temperature range. This type can also be used in switching service in circuits requiring transistors having high voltage, current, and dissipation values. JEDEC No. TO-39 package; outline 32, Outlines Section.

**2N1493**

**MAXIMUM RATINGS**

Collector-to-Base Voltage (with emitter open)	100 max	volts
Collector-to-Emitter Voltage (with emitter-to-base volts = 0.5)	100 max	volts
Emitter-to-Base Voltage (with collector open)	4.5 max	volts
Collector Current	50 max	ma
Emitter Current	-50 max	ma
Transistor Dissipation:		
At case temperatures up to 25°C	3 max	watts
At ambient temperatures up to 25°C	0.5 max	watt
At case or ambient temperatures above 25°C	See curve	page 80
Temperature Range:		
Operating (junction) and storage	-65 to 175	°C

**CHARACTERISTICS**

Collector-to-Base Breakdown Voltage (with collector ma = 0.1 and emitter current = 0)	100 min	volts
Emitter-Cutoff Current (with emitter-to-base volts = 0.5 and collector current = 0)	100 max	µa
Collector-Cutoff Current (with collector-to-base volts = 12 and emitter current = 0)	10 max	µa
Thermal Resistance:		
Junction-to-case	50 max	°C/watt

*In Common-Base Circuit*

Small-Signal Forward-Current-Transfer-Ratio Cutoff Frequency (with collector-to-base volts = 30 and collector ma = 15)	300	Mc
Collector-to-Base-and-Stem Capacitance (with collector-to-base volts = 30 and emitter current = 0)	5 max	pf

*In Common-Emitter Circuit*

Small-Signal Forward Current-Transfer Ratio:		
With collector-to-emitter volts = 20, collector ma = 15, and frequency = 1 kilocycle	50	
With collector-to-emitter volts = 30, collector ma = 15, and frequency = 100 Mc	1.8	
Power Gain at 70 Mc:		
With collector-to-base volts = 20, emitter ma = -15, and power output = 10 mw	16	db
With collector-to-base volts = 30, emitter ma = -15, and power output = 100 mw	16	db
With collector-to-base volts = 50, emitter ma = -25, and power output = 500 mw	12	db

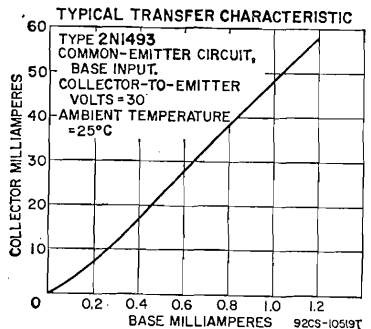
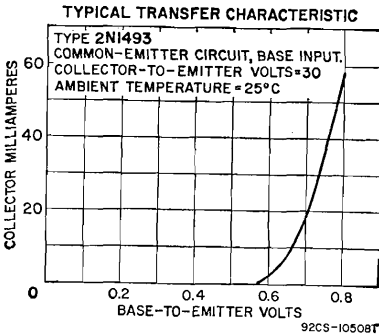

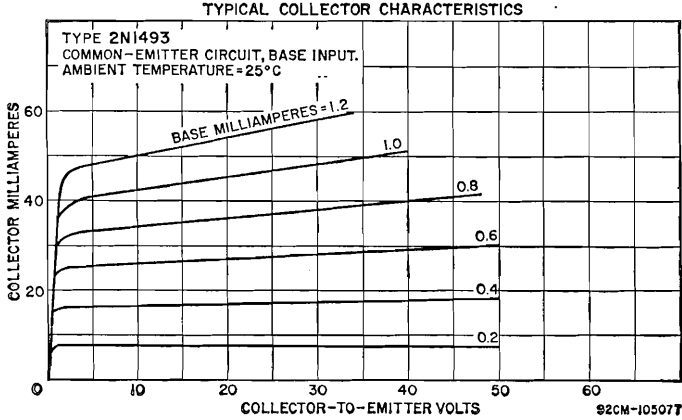

### POWER TRANSISTOR

## 2N1511

Silicon n-p-n type used in a wide variety of high-power switching and amplifier applications in industrial and military equipment. It is used in power switching, dc-to-dc converter, inverter, chopper, solenoid

and relay control circuits; in oscillator, regulator, and pulse-amplifier circuits; and as a class A or class B push-pull audio and servo amplifier. It features low saturation resistance, high current and power dissipation, high beta at high current, and excellent high-temperature performance. This type is stud-mounted to provide positive heat-sink contact and has a cold-weld seal. JEDEC No. TO-36 package; outline 14, Outlines Section. This type is electrically identical with type 2N1487.

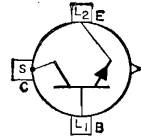

### POWER TRANSISTOR

## 2N1512

Silicon n-p-n type used in a wide variety of high-power switching and amplifier applications in industrial and military equipment. It is used in power switching, dc-to-dc converter, inverter, chopper, solenoid

and relay control circuits; in oscillator, regulator, and pulse-amplifier circuits; and as a class A or class B push-pull audio and servo amplifier. It features low saturation resistance, high current and power dissipation, high beta at high current, and excellent high-temperature performance. This type is stud-mounted to provide positive heat-sink contact and has a cold-weld seal. JEDEC No. TO-36 package; outline 14, Outlines Section. This type is electrically identical with type 2N1488.

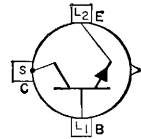

**POWER TRANSISTOR**

**2N1513**

Silicon n-p-n type used in a wide variety of high-power switching and amplifier applications in industrial and military equipment. It is used in power switching, dc-to-dc converter, inverter, chopper, solenoid and relay control circuits; in oscillator, regulator, and pulse-amplifier circuits; and as a class A or class B push-pull audio and servo amplifier. It features low saturation resistance, high current and power dissipation, high beta at high current, and excellent high-temperature performance. This type is stud-mounted to provide positive heat-sink contact and has a cold-weld seal. JEDEC No. TO-36 package; outline 14, Outlines Section. This type is electrically identical with type 2N1489.

**POWER TRANSISTOR**

**2N1514**

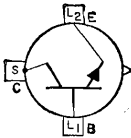

Silicon n-p-n type used in a wide variety of high-power switching and amplifier applications in industrial and military equipment. It is used in power switching, dc-to-dc converter, inverter, chopper, solenoid and relay control circuits; in oscillator, regulator, and pulse-amplifier circuits; and as a class A or class B push-pull audio and servo amplifier. It features low saturation resistance, high current and power dissipation, high beta at high current, and excellent high-temperature performance. This type is stud-mounted to provide positive heat-sink contact and has a cold-weld seal. JEDEC No. TO-36 package; outline 14, Outlines Section. This type is electrically identical with type 2N1490.

**TRANSISTOR**

**2N1524**

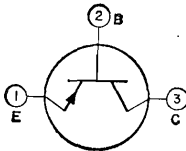

Germanium p-n-p type used in intermediate-frequency amplifier applications in battery-operated AM portable radio receivers. JEDEC No. TO-1 package; outline 4, Outlines Section.

**MAXIMUM RATINGS**

Collector-to-Base Voltage (with emitter open) .....	-24 max	volts
Emitter-to-Base Voltage (with collector open) .....	-0.5 max	volt
Collector Current .....	-10 max	ma
Emitter Current .....	10 max	ma
Transistor Dissipation:		
At ambient temperatures up to 25°C .....	80 max	mw
At ambient temperature of 55°C .....	50 max	mw
At ambient temperature of 71°C .....	23 max	mw
Ambient-Temperature Range:		
Operating and Storage .....	-65 to 85	°C

**CHARACTERISTICS**

Collector-to-Base Breakdown Voltage (with emitter-to-base volts = -0.5 and collector $\mu$ a = -50) .....	-24 min	volts
Collector-Cutoff Current (with collector-to-base volts = -12 and emitter current = 0) .....	-16 max	$\mu$ a
Emitter-Cutoff Current (with emitter-to-base volts = -0.5 and collector current = 0) .....	-16 max	$\mu$ a
Thermal Resistance:		
Junction-to-ambient .....	0.4	°C/mw

**In Common-Base Circuit**

Collector-to-Base Capacitance (with collector-to-base volts = -12, emitter current = 0, and frequency = 455 kilocycles)	3.6 max	pf
Small-Signal Forward-Current-Transfer-Ratio Cutoff Frequency (with collector-to-base volts = -12, collector ma = -1, and frequency = 1 kilocycle)	33	Mc

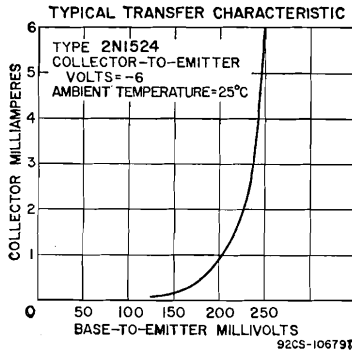

**In Common-Emitter Circuit**

Small-Signal Forward Current-Transfer Ratio (with collector-to-emitter volts = -6, collector ma = 1, and frequency = 1 kilocycle)	17 min	
Power Gain (with collector-to-emitter volts = -5.7, emitter ma = 1, and frequency = 1 kilocycle)	51 max	db

**TYPICAL OPERATION IN SINGLE-STAGE 455-KC AMPLIFIER CIRCUIT**

DC Collector-Supply Voltage	-6	-9	-12	volts
DC Collector-to-Emitter Voltage	-5.7	-8.5	-11	volts
Collector Current	-1	-1	-1	ma
Input Resistance	1300	1350	1550	ohms
Output Resistance	0.31	0.415	0.525	megohm
Collector-to-Base Capacitance	2.2	2.1	2	pf
Maximum Power Gain	51	52.4	54.4	db
Useful Power Gain:				
In neutralized circuit	33	33	33	db
In unneutralized circuit	29.7	30	30.2	db

**TYPICAL OPERATION IN TWO-STAGE 455-KC AMPLIFIER CIRCUIT**

DC Collector-Supply Voltage	-6	-6	-9	-9	-12	-12	volts
DC Collector-to-Emitter Voltage	-5.7	-5.7	-8.5	-8.5	-11	-11	volts
Collector Current	-1	-0.65	-1	-0.65	-1	-0.65	ma
Input Resistance	1300	2100	1350	2200	1550	2500	ohms
Output Resistance	0.31	0.49	0.415	0.65	0.525	0.82	megohm
Collector-to-Base Capacitance	2.2	2.2	2.1	2.1	2	2	pf
Maximum Power Gain	50.9	51.3	52.4	52.8	54	54.3	db
Useful Power Gain:							
In neutralized circuit	31.2	30	31.2	30	31.2	30	db
In unneutralized circuit	28.1	26.6	28.2	26.7	28.3	26.8	db

**TRANSISTOR**

Germanium p-n-p type used in intermediate-frequency amplifier applications in battery-operated AM portable radio receivers. JEDEC No. TO-40 package; outline 15, Outlines Section. This type is electrically

**2N1525**

identical with type 2N1524.

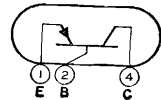



**TRANSISTOR**

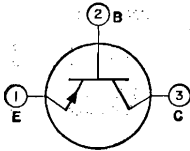

Germanium p-n-p type used in converter (mixer-oscillator) applications in battery-operated portable radio receivers. In a common-emitter circuit, this type is capable of providing a useful conversion power

**2N1526**

gain of 34.5 db. JEDEC No. TO-1 package; outline 4, Outlines Section. This type is identical with type 2N1524 except for the following items:

**CHARACTERISTICS**

*In Common-Emitter Circuit*

Small-Signal Forward Current-Transfer Ratio (with collector-to-emitter volts = 5.7, emitter ma = 1, and frequency = 1 kilocycle)  
 Power Gain (with collector-to-emitter volts = -5, emitter ma = 0.65, and frequency = 1.5 Mc)

130	db
44.2	db

**TYPICAL OPERATION IN SELF-EXCITED 1.5-MC CONVERTER CIRCUIT**

DC Collector-Supply Voltage	-6	-9	-12	volts
DC Collector-to-Emitter Voltage	-5	-8	-11	volts
DC Collector Current	-0.65	-0.65	-0.65	ma
Input Resistance	1850	1950	2150	ohms
Output Resistance	0.19	0.28	0.48	megohm
RMS Base-to-Emitter Oscillator-Injection Voltage	100	100	100	mv
Conversion Power Gain:				
Maximum available	44.2	46.1	48.9	db
Useful	34.2	34.5	35.8	db

**TRANSISTOR**

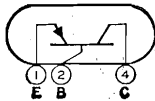

Germanium p-n-p type used in converter (mixer-oscillator) applications in battery-operated AM portable radio receivers. This type is electrically identical with type 2N1526.

**2N1527**

**TRANSISTOR**

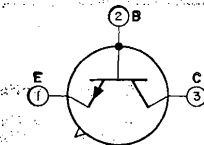

Germanium n-p-n type used in medium-speed switching applications in data-processing equipment. These transistors are n-p-n complements of the p-n-p types 2N404 and 2N404A. JEDEC No. TO-5 package;

**2N1605**  
**2N1605A**

outline 6, Outlines Section.

**MAXIMUM RATINGS**

Collector-to-Base Voltage (with emitter open)	2N1605 25 max	2N1605A 40 max	volts
Collector-to-Emitter Voltage (with base-to-emitter volts = -1)	24 max	40 max	volts
Emitter-to-Base Voltage (with collector open)	12 max	12 max	volts
Collector Current	100 max	100 max	ma
Emitter Current	-100 max	-100 max	ma
Transistor Dissipation:			
At ambient temperatures up to 25°C	150 max	200 max	mW
At ambient temperatures above 25°C	See curve page.80		
Ambient Temperature Range:			
Operating and storage	-65 to 100	-65 to 100	°C
Lead Temperature (for 10 seconds maximum)	235 max	235 max	°C

**CHARACTERISTICS**

	2N1605	2N1605A	
Collector-to-Emitter Saturation Voltage: With collector $m_a = 12$ and base $m_a = 0.4$ ...	0.15 max	0.15 max	volt
With collector $m_a = 24$ and base $m_a = 1$ ....	0.2 max	0.2 max	volt
Base-to-Emitter Voltage: With collector $m_a = 12$ and base $m_a = 0.4$ ...	0.35 max	0.35 max	volt
With collector $m_a = 24$ and base $m_a = 1$ ....	0.4 max	0.4 max	volt
Collector-Cutoff Current: With collector-to-base volts = 12 and emitter current = 0 .....	5 max	—	$\mu$ a
With collector-to-base volts = 40 and emitter current = 0 .....	—	10 max	$\mu$ a
Total Stored Charge (with collector-to-base volts = 5.25, collector $m_a = 10$ , and base $m_a = 1$ ) .....	1400	1400 max	pcoul

*In Common-Base Circuit*

	2N1605	2N1605A	
Collector-to-Base Capacitance (with collector- to-base volts = 6 and collector current = 0)	20 max	20 max	pf
Forward-Current-Transfer-Ratio Cutoff Frequency (with collector-to-base volts = 6 and emitter current = 1) .....	4 min	4 min	Mc

*In Common-Emitter Circuit*

Forward Current-Transfer Ratio: With collector-to-emitter volts = 0.15 and collector $m_a = 12$ .....	30 min	30 min	
With collector-to-emitter volts = 0.2 and collector $m_a = 24$ .....	24 min	24 min	
With collector-to-emitter volts = 0.25 and collector $m_a = 20$ .....	40 min	40 min	

**TRANSISTOR**

**2N1613**

Silicon n-p-n type used in a wide variety of small-signal and medium-power applications in industrial and military equipment. It can be used in rf service as an amplifier, mixer, oscillator, and con-

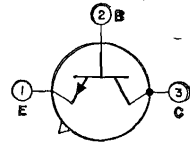

verter; in af service for small- and large-signal driver and power applications; in switching service for high-speed switching circuits requiring transistors having high voltage, high dissipation, high pulse beta, low output capacitance, and exceptionally low noise and leakage characteristics. JEDEC No. TO-5 package; outline 6, Outlines Section. For curve of typical transfer characteristics, refer to type 2N2102.

**MAXIMUM RATINGS**

Collector-to-Base Voltage (with emitter open) .....	75 max	volts
Collector-to-Emitter Voltage (with external base-to-emitter resistance = 10 ohms or less) .....	50 max	volts
Emitter-to-Base Voltage (with collector open) .....	7 max	volts
Collector Current .....	1 max	ampere
Transistor Dissipation: At case temperatures up to 25°C .....	3 max	watts
At ambient temperatures up to 25°C .....	0.8 max	watt
At case or ambient temperatures above 25°C .....	See curve	page 80
Temperature Range: Operating (junction) .....	-65 to 200	°C
Storage .....	-65 to 300	°C
Lead Temperature (for 10 seconds maximum) .....	255 max	°C

**CHARACTERISTICS**

Collector-to-Base Breakdown Voltage (with collector $m_a = 0.1$ and emitter current = 0) .....	75 min	volts
Emitter-to-Base Breakdown Voltage (with emitter $m_a = 0.25$ and collector current = 0) .....	7 min	volts
Collector-to-Emitter Reach-Through Voltage (with emitter-to-base volts = 1.5 and collector $m_a = 0.1$ ) ....	75 min	volts

Collector-to-Emitter Sustaining Voltage (with external base-to-emitter resistance = 10 ohms or less and collector ma = 100)	50 min	volts
Base-to-Emitter Saturation Voltage (with collector ma = 150 and base ma = 15)	1.3 max	volts
Collector-to-Emitter Saturation Voltage (with collector ma = 150 and base ma = 15)	1.5 max	volts
Collector-Cutoff Current (with collector-to-base volts = 60 and emitter current = 0)	0.01 max	$\mu$ a
Emitter-Cutoff Current (with emitter-to-base volts = 5 and collector current = 0)	0.01 max	$\mu$ a
Thermal Resistance:		
Junction-to-case	58.3 max	$^{\circ}$ C/watt
Junction to ambient	219 max	$^{\circ}$ C/watt

**In Common-Base Circuit**

Input Resistance at 1 kilocycle:		
With collector-to-base volts = 5 and collector ma = 1	24 to 34	ohms
With collector-to-base volts = 10 and collector ma = 5	4 to 8	ohms
Input Capacitance (with emitter-to-base volts = 0.5 and collector current = 0)	80 max	pf
Output Capacitance (with collector-to-base volts = 10 and emitter current = 0)	25 max	pf
Output Conductance at 1 kilocycle:		
With collector-to-base volts = 5 and collector ma = 1	0.1 to 0.5	$\mu$ mho
With collector-to-base volts = 10 and collector ma = 5	0.1 to 1	$\mu$ mho
Small-Signal Open-Circuit Reverse Voltage-Transfer Ratio at 1 kilocycle:		
With collector-to-base volts = 5 and collector ma = 1	0.0003 max	
With collector-to-base volts = 10 and collector ma = 5	0.0003 max	

**In Common-Emitter Circuit**

DC-Pulse Forward Current-Transfer Ratio:*		
With collector-to-emitter volts = 10 and collector ma = 150	40 to 120	
With collector-to-emitter volts = 10 and collector ma = 500	20 min	
DC Forward Current-Transfer Ratio:		
With collector-to-emitter volts = 10 and collector ma = 0.1	20 min	
With collector-to-emitter volts = 10 and collector ma = 10	35 min	
Small-Signal Forward Current-Transfer Ratio:		
With collector-to-emitter volts = 5, collector ma = 1, and frequency = 1 kilocycle	30 to 100	
With collector-to-emitter volts = 10, collector ma = 5, and frequency = 1 kilocycle	35 to 150	
With collector-to-emitter volts = 10, collector ma = 50, and frequency = 20 Mc	3 min	
Noise Figure (with collector-to-emitter volts = 10, collector ma = 0.3, generator resistance = 1000 ohms, circuit bandwidth = 15 kilocycles, and signal frequency = 1 kilocycle)	12 max	db
Total Switching Time† (delay time plus rise time plus fall time)	30 max	nsec

\* Pulse duration = 300  $\mu$ sec; duty factor = 0.018.

† Refer to type 2N2102 for Total-Switching-Time Measurement Circuit.

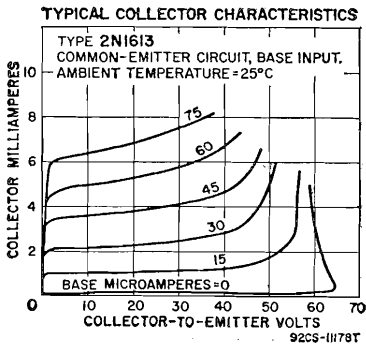

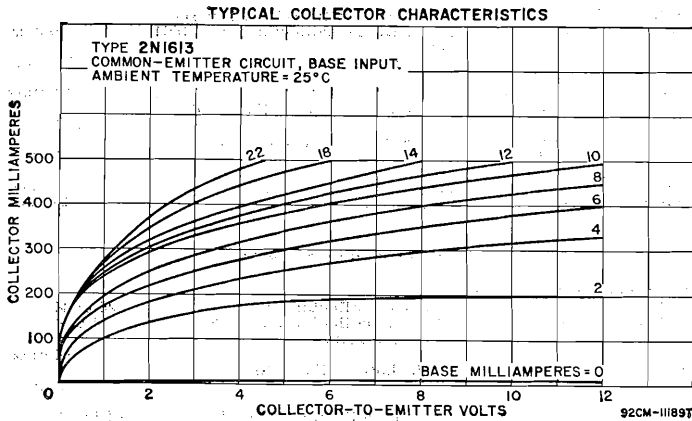

### TRANSISTOR

## 2N1631

Germanium p-n-p type used in radio-frequency amplifier applications in battery-operated AM portable radio receivers. In an unneutralized rf amplifier circuit, this type can provide a power gain of 25.6 db

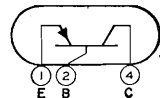

at 1.5 megacycles. JEDEC No. TO-40 package; outline 15, Outlines Section.

#### MAXIMUM RATINGS

Collector-to-Base Voltage (with emitter open)	-34 max	volts
Emitter-to-Base Voltage (with collector open)	-0.5 max	volt
Collector Current	-10 max	ma
Emitter Current	10 max	ma
Transistor Dissipation:		
At ambient temperatures up to 25°C	80 max	mw
At ambient temperature of 55°C	50 max	mw
At ambient temperature of 71°C	35 max	mw
Ambient-Temperature Range:		
Operating	-65 to 71	°C
Storage	-65 to 85	°C

#### CHARACTERISTICS

Collector-to-Base Breakdown Voltage (with collector $\mu a = -50$ and emitter current = 0)	-34 min	volts
Collector-Cutoff Current (with collector-to-base volts = -12 and emitter current = 0)	-16 max	$\mu a$
Emitter-Cutoff Current (with emitter-to-base volts = -0.5 and collector current = 0)	-16 max	$\mu a$
Thermal Resistance:		
Junction-to-ambient	0.4 max	°C/mw

#### In Common-Base Circuit

Small-Signal Forward Current-Transfer Ratio (with collector-to-base volts = -12, collector ma = -1, and frequency = 1 kilocycle)	0.987	
Small-Signal Forward-Current-Transfer-Ratio Cutoff Frequency (with collector-to-base volts = -12 and collector ma = -1)	45	Mc

#### In Common-Emitter Circuit

DC Forward Current-Transfer Ratio (with collector-to-emitter volts = -12, collector ma = -1, and frequency = 1 kilocycle)	80	
---	----	--

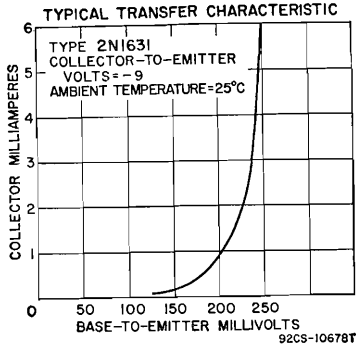

**TYPICAL OPERATION**

DC Collector-Supply Voltage	-6	-9	-12	volts
DC Collector-to-Emitter Voltage	-5.7	-8.5	-11	volts
DC Collector Current	-1	-1	-1	ma
Signal Frequency	1.5	1.5	1.5	Mc
Input Resistance (with ac output circuit shorted)	520	750	1000	ohms
Output Resistance (with ac input circuit shorted)	0.065	0.11	0.18	megohm
Extrinsic Transconductance	36000	36000	36000	$\mu$ mhos
Collector-to-Base Capacitance	2.2	2.1	2	pf
Maximum Power Gain	40.4	44.3	47.7	db
Useful Power Gain:				
In unneutralized circuit	25.3	25.5	25.6	db

**TRANSISTOR**

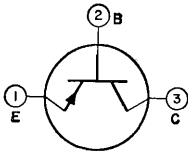

Germanium p-n-p type used in radio-frequency amplifier applications in battery-operated AM portable radio receivers. In an unneutralized rf amplifier circuit, this type can provide a power gain of 25.6 db

at 1.5 megacycles. JEDEC No. TO-1 package; outline 4, Outlines Section. This type is electrically identical with type 2N1631.

**2N1632**

See List of Discontinued Transistors at end of Technical Data Section for abbreviated data.

**2N1633**

See List of Discontinued Transistors at end of Technical Data Section for abbreviated data.

**2N1634**

See List of Discontinued Transistors at end of Technical Data Section for abbreviated data.

**2N1635**

See List of Discontinued Transistors at end of Technical Data Section for abbreviated data.

**2N1636**

**TRANSISTOR**

**2N1637**

Germanium p-n-p type used in radio-frequency amplifier applications in AM automobile radio receivers. In an unneutralized circuit, this type is capable of providing a useful power gain of 25.6 db at 1

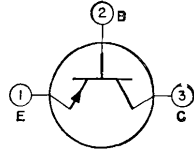

megacycle. JEDEC No. TO-1 package; outline 4, Outlines Section.

**MAXIMUM RATINGS**

Collector-to-Base Voltage (with emitter open) .....	-34 max	volts
Emitter-to-Base Voltage (with collector open) .....	-1.5 max	volts
Collector Current .....	-10 max	ma
Emitter Current .....	10 max	ma
Transistor Dissipation:		
At ambient temperatures up to 25°C .....	80 max	mw
At ambient temperature of 55°C .....	50 max	mw
At ambient temperature of 71°C .....	35 max	mw
Ambient-Temperature Range:		
Operating .....	-65 to 71	°C
Storage .....	-65 to 85	°C

**CHARACTERISTICS**

Collector-to-Base Breakdown Voltage (with collector $\mu$ = -50 and emitter current = 0) .....	-34 min	volts
Collector-Cutoff Current (with collector-to-base volts = -12 and emitter current = 0) .....	-5 max	$\mu$ a
Emitter-Cutoff Current (with emitter-to-base volts = -1.5 and collector current = 0) .....	-15 max	$\mu$ a
Thermal Resistance:		
Junction-to-ambient .....	0.4 max	°C/mw

*In Common-Base Circuit*

Small-Signal Forward Current-Transfer Ratio (with collector-to-base volts = -12, collector ma = -1, and frequency = 1 kilocycle) .....	0.987	
Small-Signal Forward-Current-Transfer-Ratio Cutoff Frequency (with collector-to-base volts = -12 and collector ma = -1) ..	45	Mc
Collector-to-Base Capacitance .....	2	pf

*In Common-Emitter Circuit*

DC Forward Current-Transfer Ratio (with collector-to-emitter volts = -12 and collector ma = -1) .....	80
---	----

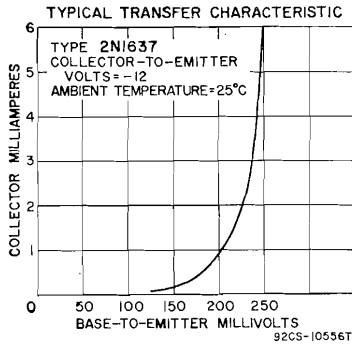

**TYPICAL OPERATION**

DC Collector-to-Emitter Voltage .....	-5.5	-11.2	volts
DC Collector Current .....	-1	-1	ma
Signal Frequency .....	1.5	1.5	Mc
Input Resistance (with ac output circuit shorted) ..	520	1000	ohms
Output Resistance (with ac input circuit shorted) ...	0.065	0.18	megohm
Maximum Power Gain .....	40.4	47.7	db
Maximum Useful Power Gain:			
In unneutralized circuit .....	25.3	25.6	db

**TRANSISTOR**

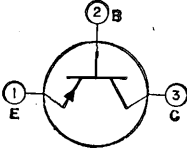

Germanium p-n-p type used in 262.5-kilocycle or 455-kilocycle intermediate-frequency amplifier applications in AM automobile radio receivers. In an unneutralized circuit, this type is capable of providing a useful power gain of 36.6 db at 262.5 kilocycles. JEDEC No. TO-1 package; outline 4, Outlines Section. This type is identical with type 2N1637 except for the following:

**2N1638**

**MAXIMUM RATINGS**

Emitter-to-Base Voltage (with collector open) ..... -0.5 max volt

**CHARACTERISTICS**

Collector-Cutoff Current (with collector-to-base volts = -12 and emitter current = 0) ..... -7 max  $\mu$ a  
 Emitter-Cutoff Current (with emitter-to-base volts = -0.5 and collector current = 0) ..... -8 max  $\mu$ a

*In Common-Base Circuit*

Small-Signal Forward Current-Transfer Ratio (with collector-to-base volts = -12, collector ma = -1, and frequency = 1 kilocycle) ..... 0.986  
 Small-Signal Forward-Current-Transfer-Ratio Cutoff Frequency (with collector-to-base volts = 12 and collector ma = -1) .. 40 Mc

*In Common-Emitter Circuit*

DC Forward Current-Transfer Ratio (with collector-to-emitter volts = -12 and collector ma = -1) ..... 75

**TYPICAL OPERATION IN SINGLE-STAGE 262.5-KC AMPLIFIER CIRCUIT**

DC Collector-to-Emitter Voltage .....	-5	-11	volts
DC Collector Current .....	-1.6	-2	ma
Input Resistance .....	1800	1400	ohms
Output Resistance .....	0.47	0.72	megohm
Maximum Power Gain .....	58.6	61.5	db
Useful Power Gain:			
In unneutralized circuit .....	35	36.6	db

**TRANSISTOR**

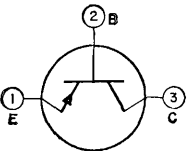

Germanium p-n-p type used in converter (mixer-oscillator) applications in AM automobile radio receivers. In an unneutralized circuit, this type can provide a useful conversion power gain of 37 db at 1.5 megacycles. JEDEC No. TO-1 package; outline 4, Outlines Section. This type is identical with type 2N1637 except for the following items:

**2N1639**

**MAXIMUM RATINGS**

Emitter-to-Base Voltage (with collector open) ..... -0.5 max volt

**CHARACTERISTICS**

Collector-Cutoff Current (with collector-to-base volts = -12 and emitter current = 0) ..... -7  $\mu$ a  
 Emitter-Cutoff Current (with emitter-to-base volts = -0.5 and collector current = 0) ..... -8  $\mu$ a

*In Common-Base Circuit*

Small-Signal Forward Current-Transfer Ratio (with collector-to-base volts = -12, collector ma = -1, and frequency = 1 kilocycle) ..... 0.986

**In Common-Emitter Circuit**

DC Forward Current-Transfer Ratio (with collector-to-emitter volts = -12 and collector ma = -1) ..... 75

**TYPICAL OPERATION**

DC Collector-to-Emitter Voltage .....	-5	-11	volts
DC Collector Current .....	-0.65	-0.65	ma
Signal Frequency .....	1.5	1.5	Mc
Input Resistance .....	1850	2200	ohms
Output Resistance at 252.5 kilocycles .....	0.1	0.2	megohm
RMS Base-to-Emitter Oscillator-Injection Voltage .....	100	100	mv
Useful Conversion Power Gain .....	35.4	37	db

**TRANSISTOR**

**2N1683**

Germanium p-n-p type used in high-speed switching applications in data-processing equipment. JEDEC No. TO-5 package; outline 6, Outlines Section.

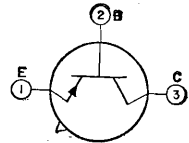

**MAXIMUM RATINGS**

Collector-to-Base Voltage (with emitter open) .....	-13 max	volts
Collector-to-Emitter Voltage (with base open) .....	-12 max	volts
Emitter-to-Base Voltage (with collector open) .....	-4 max	volts
Collector Current .....	-100 max	ma
Emitter Current .....	100 max	ma
Transistor Dissipation:		
At ambient temperatures up to 25°C .....	150 max	mw
At ambient temperatures above 25°C .....	See curve	page 80
Ambient-Temperature Range:		
Operating and storage .....	-65 to 85	°C
Lead Temperature (for 10 seconds maximum) .....	255 max	°C

**CHARACTERISTICS**

Base-to-Emitter Voltage (with collector ma = -40 and base ma = -1) .....	-0.6 max	volt
Collector-Cutoff Current (with collector volts = -6 and emitter current = 0) .....	-3 max	µA
Total Stored Charge:		
With collector ma = -10 and base ma = -0.4 .....	160 max	pcoul
With collector ma = -40 and base ma = -1.6 .....	410 max	pcoul

**In Common-Base Circuit**

Collector Capacitance (with collector-to-base volts = -6 and emitter current = 0) ..... 12 max pf

**In Common-Emitter Circuit**

Forward Current-Transfer Ratio:  
 With collector-to-emitter volts = -0.3 and collector ma = -10 ..... 50 min  
 With collector-to-emitter volts = -0.5 and collector ma = -40 ..... 50 min  
 Gain-Bandwidth Product (with collector-to-emitter volts = -3 and collector ma = -10) ..... 50 min Mc

**POWER TRANSISTOR**

**2N1700**

Silicon n-p-n type used in a wide variety of switching and amplifier applications in industrial equipment. It is used in power switching, dc-to-dc converter, inverter, chopper, and relay-control circuits; in oscillator, voltage- and current-regulator circuits; and in dc and servo amplifier circuits. JEDEC No. TO-5 package; outline 6, Outlines Section.

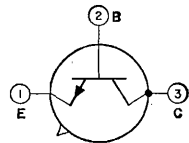



**MAXIMUM RATINGS**

Collector-to-Base Voltage (with emitter open) .....	60 max	volts
Collector-to-Emitter Voltage:		
With emitter-to-base volts = 1.5 .....	60 max	volts
With base open .....	40 max	volts
Emitter-to-Base Voltage .....	6 max	volts
Collector Current .....	1 max	ampere
Base Current .....	0.75 max	ampere
Transistor Dissipation:		
At case temperatures up to 25°C .....	5 max	watts
At case temperatures above 25°C .....	See curve	page 80
Temperature Range:		
Operating (junction) and storage .....	-65 to 200	°C
Lead Temperature (for 10 seconds maximum) .....	255 max	°C

**CHARACTERISTICS**

Collector-to-Emitter Breakdown Voltage (with emitter-to-base volts = 1.5 and collector ma = 0.5) ....	60 min	volts
Collector-to-Emitter Sustaining Voltage (with collector ma = 50 and base current = 0) .....	40 min	volts
Base-to-Emitter Voltage (with collector-to-emitter volts = 4 and collector ma = 100) .....	2 max	volts
Collector-Cutoff Current (with collector-to-base volts = 30 and emitter current = 0) .....	75 max	µa
Emitter-Cutoff Current (with emitter-to-base volts = 6 and collector current = 0) .....	25 max	µa
Thermal Resistance:		
Junction-to-case .....	35 max	°C/watt
Junction-to-ambient .....	200 max	°C/watt
Thermal Time Constant .....	10	msec

*In Common-Base Circuit*

Small-Signal Forward-Current-Transfer-Ratio Cutoff Frequency (with collector-to-base volts = 28 and collector ma = 5) .....	1.2	Mc
Collector-to-Base Capacitance (with collector-to-base volts = 40 and emitter current = 0) .....	150	pf

*In Common-Emitter Circuit*

DC Forward Current-Transfer Ratio (with collector-to-emitter volts = 4 and collector ma = 100) .....	20 to 80	
Small-Signal Forward Current-Transfer Ratio (with collector-to-emitter volts = 4 and collector ma = 5) ..	40	
DC Collector-to-Emitter Saturation Resistance (with collector ma = 100 and base ma = 10) .....	10 max	ohms

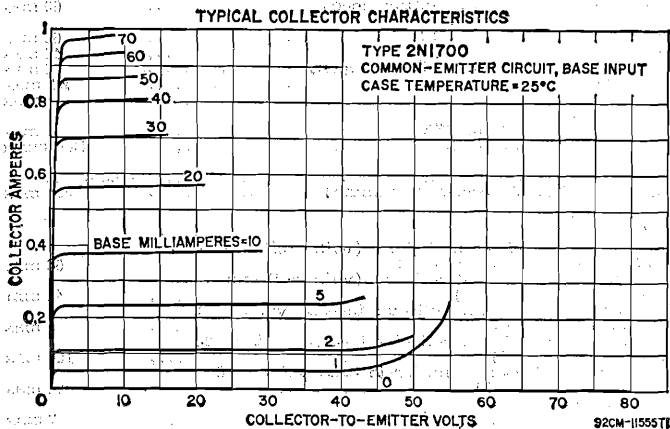

**TYPICAL OPERATION IN POWER-SWITCHING CIRCUIT**

DC Collector Supply Voltage (V <sub>CC</sub> ) .....	12	volts
DC Base Supply Voltage (V <sub>BB</sub> ) .....	-8.5	volts
Generator Resistance .....	50	ohms
Qn DC Collector Current (I <sub>c</sub> ) .....	200	ma

Turn-On DC Base Current ( $I_{B1}$ ) .....	20	ma
Turn-Off DC Base Current ( $I_{B2}$ ) .....	-8.5	ma
Switching Time:		
Delay time ( $t_d$ ) .....	0.2	$\mu$ sec
Rise time ( $t_r$ ) .....	1	$\mu$ sec
Storage time ( $t_s$ ) .....	0.6	$\mu$ sec
Fall time ( $t_f$ ) .....	1	$\mu$ sec

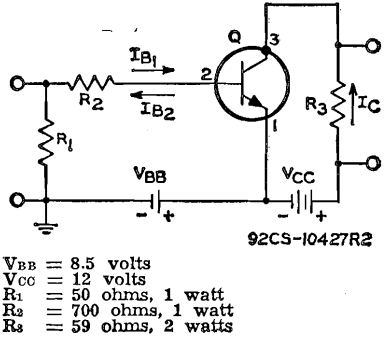
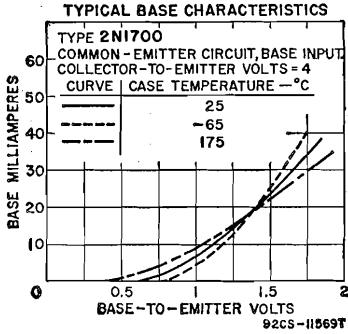

**POWER TRANSISTOR**

**2N1701**

Silicon n-p-n type used in a wide variety of switching and amplifier applications in industrial equipment. It is used in power-switching, dc-to-dc converter, inverter, chopper, and relay-control circuits; in oscillator, voltage- and current-regulator circuits; and in dc and servo amplifier circuits. JEDEC No. TO-8 package; outline 8, Outlines Section.

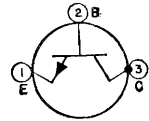

**MAXIMUM RATINGS**

Collector-to-Base Voltage (with emitter open) .....	60 max	volts
Collector-to-Emitter Voltage:		
With emitter-to-base volts = 1.5 .....	60 max	volts
With base open .....	40 max	volts
Emitter-to-Base Voltage (with collector open) .....	6 max	volts
Collector Current .....	2.5 max	amperes
Base Current .....	1 max	ampere
Transistor Dissipation:		
At case temperatures up to 25°C .....	25 max	watts
At case temperatures above 25°C .....	See curve	page 80
Temperature Range:		
Operating (junction) and storage .....	-65 to 200	°C
Lead Temperature (for 10 seconds maximum) .....	235 max	°C

**CHARACTERISTICS**

Collector-to-Emitter Breakdown Voltage (with emitter-to-base volts = 1.5 and collector ma = 0.75) .....	60 min	volts
Collector-to-Emitter Sustaining Voltage (with collector ma = 100 and base current = 0) .....	40 min	volts
Base-to-Emitter Voltage (with collector-to-base volts = 4 and collector ma = 300) .....	3 max	volts
Collector-Cutoff Current (with collector-to-base volts = 30 and emitter current = 0) .....	100 max	$\mu$ A
Emitter-Cutoff Current (with emitter-to-base volts = 6 and collector current = 0) .....	50 max	$\mu$ A
Thermal Resistance:		
Junction-to-case .....	7 max	°C/watt
Junction-to-ambient .....	100 max	°C/watt
Thermal Time Constant .....	10	msec

**In Common-Base Circuit**

Small-Signal Forward Current-Transfer-Ratio Cutoff Frequency (with collector-to-base volts = 28 and collector ma = 5) .....	1	Mc
Collector-to-Base Capacitance (with collector-to-base volts = 40 and emitter current = 0) .....	175	pf

In Common-Emitter Circuit

DC Forward Current-Transfer Ratio (with collector-to-emitter volts = 4 and collector ma = 300)	20 to 80
DC Collector-to-Emitter Saturation Resistance (with collector ma = 300 and base ma = 30)	5 max ohms

TYPICAL OPERATION IN POWER-SWITCHING CIRCUIT BELOW

DC Collector Supply Voltage ( $V_{CC}$ )	12	volts
DC Base Supply Voltage ( $V_{BB}$ )	-8.5	volts
Generator Resistance	50	ohms
On DC Collector Current ( $I_C$ )	750	ma
Turn-On DC Base Current ( $I_{B1}$ )	20	ma
Turn-Off DC Base Current ( $I_{B2}$ )	-8.5	ma
Switching Time:		
Delay time ( $t_d$ )	0.2	$\mu$ sec
Rise time ( $t_r$ )	1	$\mu$ sec
Storage time ( $t_s$ )	0.8	$\mu$ sec
Fall time ( $t_f$ )	1.1	$\mu$ sec

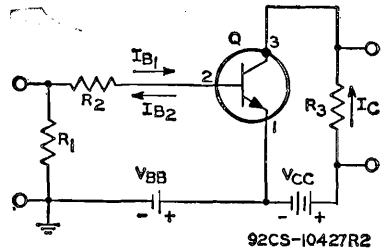
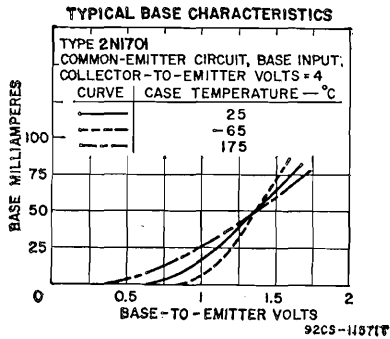

- $V_{BB} = 8.5$  volts
- $V_{CC} = 12$  volts
- $R_1 = 50$  ohms, 1 watt
- $R_2 = 220$  ohms, 1 watt
- $R_3 = 15.9$  ohms, 2 watts

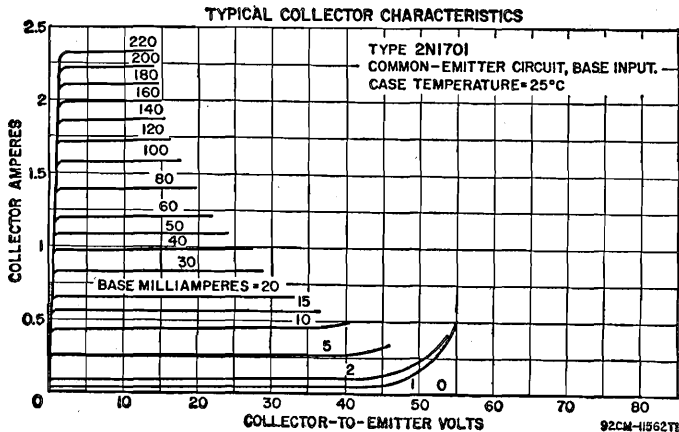

**POWER TRANSISTOR**

**2N1702**

Silicon n-p-n type used in a wide variety of switching and amplifier applications in industrial equipment. It is used in power-switching, dc-to-dc converter, inverter, chopper, and relay-control circuits; in

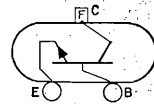

oscillator, voltage- and current-regulator circuits; and in dc and servo amplifier circuits. Package is similar to JEDEC No. TO-3; outline 23, Outlines Section.

**MAXIMUM RATINGS**

Collector-to-Base Voltage (with emitter open)	60 max	volts
Collector-to-Emitter Voltage:		
With emitter-to-base volts = 1.5	60 max	volts
With base open	40 max	volts
Emitter-to-Base Voltage (with collector open)	6 max	volts
Collector Current	5 max	amperes
Base Current	2.5 max	amperes
Transistor Dissipation:		
At mounting-flange temperatures up to 25°C	75 max	watts
At mounting-flange temperatures above 25°C	See curve	page 80
Temperature Range:		
Operating (junction) and storage	-65 to 200	°C

**CHARACTERISTICS**

Collector-to-Emitter Breakdown Voltage (with emitter-to-base volts = 1.5 and collector ma = 1)	60 min	volts
Collector-to-Emitter Sustaining Voltage (with collector ma = 100 and base current = 0)	40 min	volts
Base-to-Emitter Voltage (with collector-to-emitter volts = 4 and collector ma = 800)	4 max	volts
Collector-Cutoff Current (with collector-to-base volts = 30 and emitter current = 0)	200 max	µa
Emitter-Cutoff Current (with emitter-to-base volts = 6 and collector current = 0)	100 max	µa
Thermal Resistance:		
Junction-to-mounting-flange	2.33 max	°C/watt
Thermal Time Constant	12	msec

*In Common-Base Circuit*

Small-Signal Forward-Current-Transfer-Ratio Cutoff Frequency (with collector-to-base volts = 28 and collector ma = 5)	1	Mc
Collector-to-Base Capacitance (with collector-to-base volts = 40 and emitter current = 0)	200	pf

*In Common-Emitter Circuit*

DC Forward Current-Transfer Ratio (with collector-to-emitter volts = 4 and collector ma = 800)	15 to 60	
Collector-to-Emitter Saturation Resistance (with collector ma = 800 and base ma = 80)	4 max	ohms

**TYPICAL BASE CHARACTERISTICS**

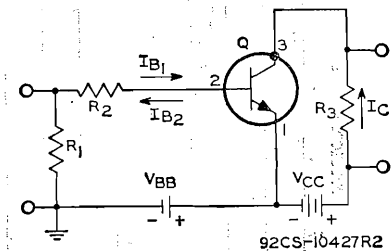
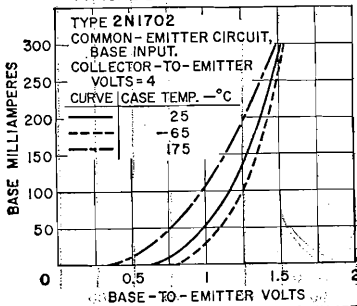

- V<sub>BB</sub> = 8.5 volts
- V<sub>CC</sub> = 12 volts
- R<sub>1</sub> = 50 ohms, 1 watt
- R<sub>2</sub> = 30 ohms, 1 watt
- R<sub>3</sub> = 7.8 ohms, 2 watts

**TYPICAL OPERATION IN POWER-SWITCHING CIRCUIT**

DC Collector Supply Voltage ( $V_{CC}$ )	12	volts
DC Base Supply Voltage ( $V_{BB}$ )	-8.5	volts
Generator Resistance	50	ohms
On DC Collector Current ( $I_C$ )	1.5	amperes
Turn-On DC Base Current ( $I_{B1}$ )	300	ma
Turn-Off DC Base Current ( $I_{B2}$ )	-150	ma
Switching Time:		
Delay time ( $t_d$ )	0.2	$\mu$ sec
Rise time ( $t_r$ )	1	$\mu$ sec
Storage time ( $t_s$ )	1	$\mu$ sec
Fall time ( $t_f$ )	1.2	$\mu$ sec

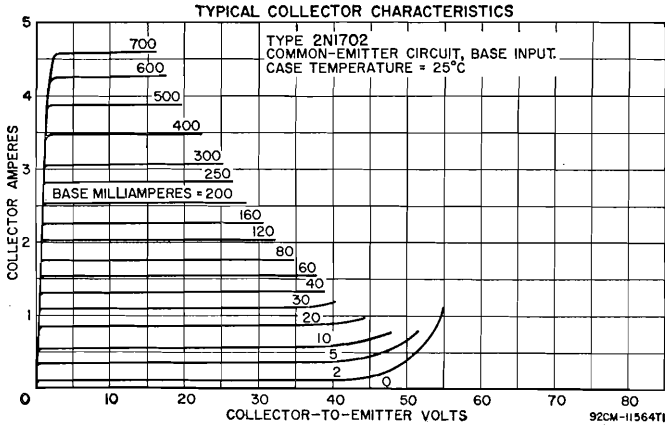

**POWER TRANSISTOR**

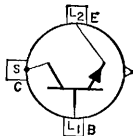

Silicon n-p-n type used in a wide variety of switching and amplifier applications in industrial equipment. It is used in power-switching, dc-to-dc converter, inverter, chopper, and relay-control circuits; in

**2N1703**

oscillator, voltage- and current-regulator circuits; and in dc and servo amplifier circuits. This type is stud-mounted to provide positive heat-sink contact and has a cold-weld seal. JEDEC No. TO-36 package; outline 14, Outlines Section. This type is electrically identical with type 2N1702.

**TRANSISTOR**

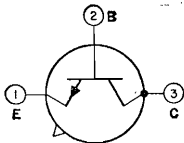

Silicon n-p-n type used in very-high-speed applications in equipments which require high reliability and high packaging densities. JEDEC No. TO-46 package; outline 18, Outlines Section.

**2N1708**

**MAXIMUM RATINGS**

Collector-to-Base Voltage (with emitter open)	25 max	volts
Collector-to-Emitter Voltage (with external base-to-emitter resistance = 1000 ohms and load resistance = 100 ohms)	12 max	volts
Emitter-to-Base Voltage (with collector open)	3 max	volts

Collector Current .....	0.2 max	ampere
Transistor Dissipation:		
At case temperatures up to 25°C .....	1 max	watt
At ambient temperatures up to 25°C .....	0.3 max	watt
At case or ambient temperatures above 25°C .....	See curve	page 80
Temperature Range:		
Operating (junction) .....	-65 to 175	°C
Storage .....	-65 to 300	°C
Lead Temperature (for 10 seconds maximum) .....	235 max	°C

### CHARACTERISTICS

Base-to-Emitter Saturation Voltage (with collector $i_a = 10$ and base $i_b = 1$ ) .....	0.7 to 0.9	volt
Collector-to-Emitter Saturation Voltage:		
With collector $i_a = 10$ and base $i_b = 1$ .....	0.22 max	volt
With collector $i_a = 50$ and base $i_b = 5$ .....	0.35 max	volt
Collector-Cutoff Current (with collector-to-base volts = 15 and emitter current = 0) .....	0.025 max	$\mu$ A

#### In Common-Base Circuit

Collector-to-Base Capacitance (with collector-to-base volts = 10, emitter current = 0, and frequency = 140 kilocycles) .....	6 max	pf
--	-------	----

#### In Common-Emitter Circuit

DC Forward Current-Transfer Ratio (with collector-to-emitter volts = 1 and collector $i_a = 10$ ) .....	20 min
Small-Signal Forward Current-Transfer Ratio (with collector-to-emitter volts = 10, collector $i_a = 10$ , and frequency = 100 Mc) .....	2 min

## TRANSISTOR

Silicon n-p-n type used in a wide variety of small-signal and medium-power applications in industrial and military equipment. It can be used in rf service as an amplifier, mixer, oscillator, and converter; in af service for small- and large-signal driver and power applications.

# 2N1711

It features low saturation voltage, high sustaining voltage, high dissipation, high pulse beta, low output capacitance, and exceptionally low noise and leakage characteristics. JEDEC No. TO-5 package; outline 6, Outlines Section. For curves of transfer characteristics, refer to type 2N2102.

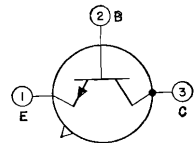

### MAXIMUM RATINGS

Collector-to-Base Voltage (with emitter open) .....	75 max	volts
Collector-to-Emitter Voltage (with external base-to-emitter resistance = 10 ohms or less) .....	50 max	volts
Emitter-to-Base Voltage (with collector open) .....	7 max	volts
Collector Current .....	1 max	ampere
Transistor Dissipation:		
At case temperatures up to 25°C .....	3 max	watts
At ambient temperatures up to 25°C .....	0.8 max	watt
At case or ambient temperatures above 25°C .....	See curve	page 80
Temperature Range:		
Operating (junction) .....	-65 to 200	°C
Storage .....	-65 to 300	°C

### CHARACTERISTICS

Collector-to-Base Breakdown Voltage (with collector $i_a = 0.1$ and emitter current = 0) .....	75 min	volts
Emitter-to-Base Breakdown Voltage (with emitter $i_b = 0.1$ and collector current = 0) .....	7 min	volts
Collector-to-Emitter Reach-Through Voltage (with emitter-to-base volts = 1.5 and collector $i_a = 0.1$ ) .....	75 min	volts
Collector-to-Emitter Sustaining Voltage (with external base-to-emitter resistance = 10 ohms or less and pulse collector $i_a = 100$ ) .....	50 min	volts
Base-to-Emitter Saturation Voltage (with collector $i_a = 150$ and base $i_b = 15$ ) .....	1.3 max	volts
Collector-to-Emitter Saturation Voltage (with collector $i_a = 150$ and base $i_b = 15$ ) .....	1.5 max	volts
Collector-Cutoff Current (with collector-to-base volts = 60 and emitter current = 0) .....	0.01 max	$\mu$ A

TYPICAL COLLECTOR CHARACTERISTICS

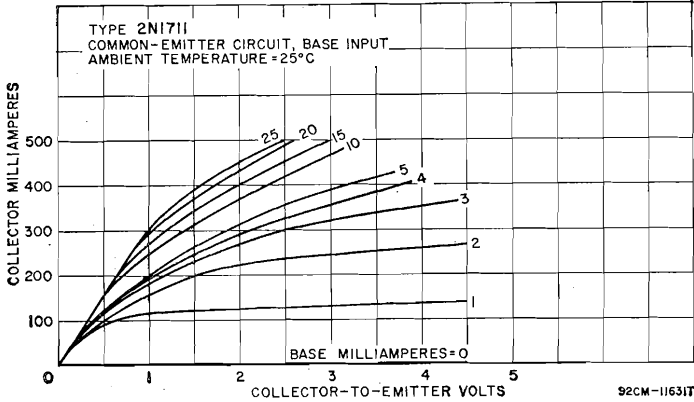

TYPICAL COLLECTOR CHARACTERISTICS

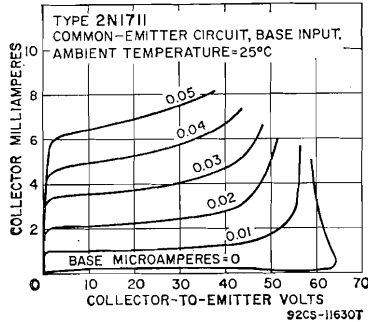

Emitter-Cutoff Current (with emitter-to-base volts = 5 and collector current = 0) .....	0.005 max	μa
Thermal Resistance:		
Junction-to-case .....	58.3 max	°C/watt
Junction-to-ambient .....	219 max	°C/watt

**In Common-Base Circuit**

Input Resistance at 1 kilocycle:		
With collector-to-base volts = 5 and collector ma = 1 .....	24 to 34	ohms
With collector-to-base volts = 10 and collector ma = 5 .....	4 to 8	ohms
Input Capacitance (with emitter-to-base volts = 0.5 and collector current = 0) .....	80 max	pf
Output Capacitance (with collector-to-base volts = 10 and emitter current = 0) .....	25 max	pf
Output Capacitance at 1 kilocycle:		
With collector-to-base volts = 5 and collector ma = 1 .....	0.1 to 0.5	μmho
With collector-to-base volts = 10 and collector ma = 5 .....	0.1 to 1	μmho
Small-Signal Open-Circuit Reverse Voltage-Transfer Ratio at 1 kilocycle:		
With collector-to-base volts = 5 and collector ma = 1 .....	0.0005 max	
With collector-to-base volts = 10 and collector ma = 5 .....	0.0005 max	

**In Common-Emitter Circuit**

DC-Pulse Forward Current-Transfer Ratio:*		
With collector-to-emitter volts = 10 and collector ma = 10 ..	75 min	
With collector-to-emitter volts = 10 and collector ma = 150 ..	100 to 300	
With collector-to-emitter volts = 10 and collector ma = 500 ..	40 min	
DC Forward Current-Transfer Ratio:		
With collector-to-emitter volts = 10 and collector ma = 0.01 ..	20 min	
With collector-to-emitter volts = 10 and collector ma = 0.1 ..	35 min	

**Small-Signal Forward Current-Transfer Ratio:**

With collector-to-emitter volts = 5, collector ma = 1, and frequency = 1 kilocycle	50 to 200	
With collector-to-emitter volts = 10, collector ma = 5, and frequency = 1 kilocycle	70 to 300	
With collector-to-emitter volts = 10, collector ma = 50, and frequency = 20 megacycles	3.5 min	
Noise Figure (with collector-to-emitter volts = 10, collector ma = 0.3, generator resistance = 510 ohms, circuit bandwidth = 1 cycle, and signal frequency = 1 kilocycle)	8 max	dB

\* Pulse duration = 300  $\mu$ sec; duty factor = 0.018.

**POWER TRANSISTOR**

**2N1768**

Silicon n-p-n type used in a wide variety of intermediate-power switching and amplifier applications in industrial equipment requiring transistors having high voltage, current, and dissipation values. It is

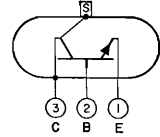

used in power switching, dc-to-dc converter, inverter, chopper, and relay actuating circuits; in voltage- and current-regulator circuits; and in dc and servo amplifier circuits. This type has an offset pedestal, stud-mount arrangement which provides positive heat-sink contact. Outline 28, Outlines Section. This type is electrically identical with type 2N1486 except for the following items:

**MAXIMUM RATINGS**

Collector-to-Base Voltage (with emitter open)	60 max	volts
Collector-to-Emitter Voltage:		
With emitter-to-base volts = 1.5	60 max	volts
With base open	40 max	volts
Transistor Dissipation:		
At case temperatures up to 25°C	40 max	watts
At case temperatures above 25°C	See curve	page 80
Lead Temperature (for 10 seconds maximum)	255 max	°C

**CHARACTERISTICS**

Collector-to-Emitter Breakdown Voltage (with emitter-to-base volts = 1.5 and collector ma = 0.25)	60 min	volts
Collector-to-Emitter Sustaining Voltage (with collector ma = 100 and base current = 0)	40 min	volts
Thermal Resistance:		
Junction-to-case	4.375 max	°C/watt
Junction-to-ambient	175 max	°C/watt

**POWER TRANSISTOR**

**2N1769**

Silicon n-p-n type used in a wide variety of intermediate-power switching and amplifier applications in industrial equipment requiring transistors having high voltage, current, and dissipation values. It is

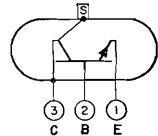

used in power-switching, dc-to-dc converter, inverter, chopper, and relay actuating circuits; in voltage- and current-regulator circuits; and in dc and servo amplifier circuits. This type has an offset pedestal, stud-mount arrangement which provides positive heat-sink contact. Outline 28, Outlines Section. This type is identical with type 2N1486 except for the following items:

**MAXIMUM RATINGS**

Transistor Dissipation:		
At case temperatures up to 25°C	40 max	watts
At case temperatures above 25°C	See curve	page 80
Lead Temperature (for 10 seconds maximum)	255 max	°C

**CHARACTERISTICS**

Thermal Resistance:		
Junction-to-case	4.375 max	°C/watt
Junction-to-ambient	175 max	°C/watt



SILICON CONTROLLED RECTIFIER

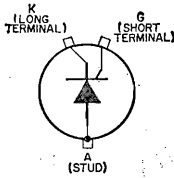

2N1842A

Diffused-junction n-p-n-p type used in a wide variety of power-control and power-switching applications in industrial and military equipment. This type has a maximum peak forward blocking voltage

of 25 volts and a forward-current capability of 10 amperes (average value) or 16 amperes (rms value). This type is designed to meet stringent military environmental and mechanical specifications. The special high-strength copper-alloy stud can withstand an installing torque up to 50 inch-pounds. JEDEC No. TO-48 package; outline 19, Outlines Section.

MAXIMUM RATINGS

For sinusoidal ac supply voltage of 50 to 400 cps, with resistive or inductive load

Peak Reverse Voltage:		
Repetitive	25 max	volts
Non-repetitive (transient)	35 max	volts
Peak Forward Blocking Voltage (repetitive)	25 max	volts
Peak Gate Voltage:		
Forward	10 max	volts
Reverse	5 max	volts
Average Forward Current:		
At case temperature of 80°C and conduction angle of 180°	10 max	amperes
For other case temperatures and conduction angles	See Rating Chart I	
Peak Surge Current:		
For one cycle of applied voltage	125 max	amperes
For more than one cycle of applied voltage	See Rating Chart II	
Peak Forward Gate Current	2 max	amperes
Peak Gate Power	5 max	watts
Average Gate Power	0.5 max	watt
Temperature Range:		
Operating (case)	-65 to 125	°C
Operating (ambient)	See Rating Chart III	
Storage	-65 to 125	°C

CHARACTERISTICS

Forward Breakover Voltage (at case temperature of 125°C)	25 min	volts
Average Forward Voltage Drop (at case temperature of 80°C)	1.2 max	volts
DC Gate-Trigger Voltage:		
At case temperature of -40°C	3.5 max	volts
At case temperature of -65°C	3.7 max	volts
At case temperature of 100°C	0.3 min	volt
At case temperature of 125°C	0.25 min	volt
Average Blocking Current (at case temperature of 125°C):		
Forward	22.5 max	ma
Reverse	22.5 max	ma
DC Gate-Trigger Current (at case temperature of 125°C)	45 max	ma
Holding Current (at case temperature of 125°C)	8	ma
Thermal Resistance (junction-to-case)	2 max	°C/watt

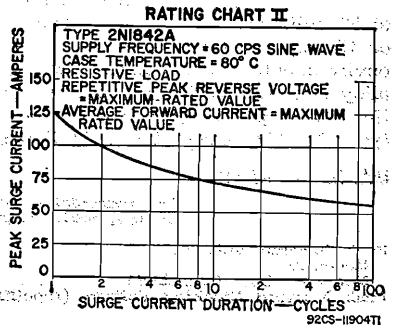
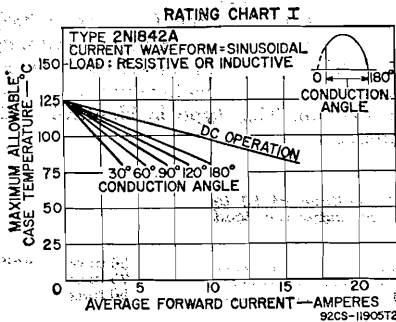

92CS-11905T2

92CS-11904T1

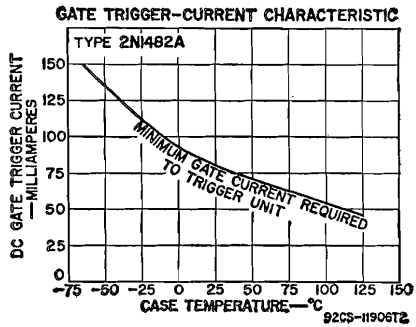
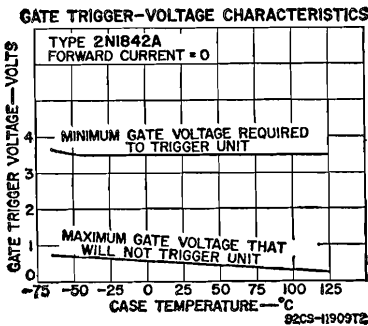
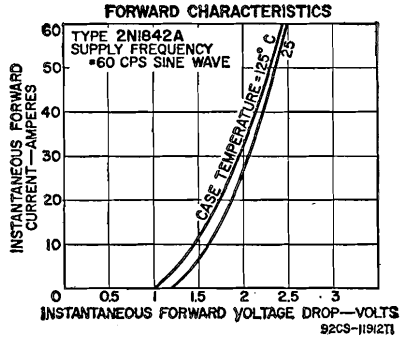
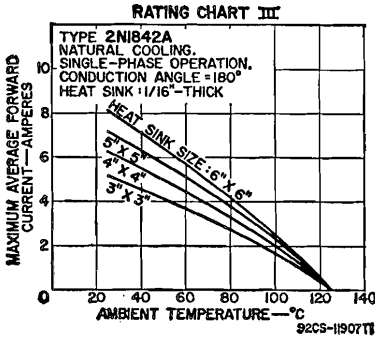

### SILICON CONTROLLED RECTIFIER

## 2N1843A

Diffused-junction n-p-n-p type used in a wide variety of power-control and power-switching applications in industrial and military equipment. This type has a maximum peak forward blocking voltage

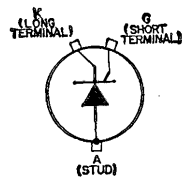

of 50 volts and a forward-current capability of 10 amperes (average value) or 16 amperes (rms value). This type is designed to meet stringent military environmental and mechanical specifications. The special high-strength copper-alloy stud can withstand an installing torque up to 50 inch-pounds. JEDEC No. TO-48 package; outline 19, Outlines Section. This type is identical with type 2N1842A except for the following items:

#### MAXIMUM RATINGS

*For sinusoidal ac supply voltage of 50 to 400 cps, with resistive or inductive load*

Peak Reverse Voltage:		
Repetitive .....	50 max	volts
Non-repetitive (transient) .....	75 max	volts
Peak Forward Blocking Voltage (repetitive) .....	50 max	volts

**CHARACTERISTICS**

Forward Breakover Voltage (at case temperature of 125°C) ....	50 min	volts
Average Blocking Current (at case temperature of 125°C):		
Forward .....	19 max	ma
Reverse .....	19 max	ma

**SILICON CONTROLLED RECTIFIER**

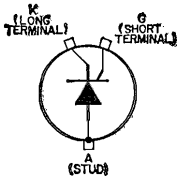

Diffused-junction n-p-n-p type used in a wide variety of power-control and power-switching applications in industrial and military equipment. This type has a maximum peak forward blocking voltage

**2N1844A**

of 100 volts and a forward-current capability of 10 amperes (average value) or 16 amperes (rms value). This type is designed to meet stringent military environmental and mechanical specifications. The special high-strength copper-alloy stud can withstand an installing torque up to 50 inch-pounds. JEDEC No. TO-48 package; outline 19, Outlines Section. This type is identical with type 2N1842A except for the following items:

**MAXIMUM RATINGS**

*For sinusoidal ac supply voltage of 50 to 400 cps, with resistive or inductive load*

Peak Reverse Voltage:		
Repetitive .....	100 max	volts
Non-repetitive (transient) .....	150 max	volts
Peak Forward Blocking Voltage (repetitive) .....	100 max	volts

**CHARACTERISTICS**

Forward Breakover Voltage (at case temperature of 125°C) ....	100 min	volts
Average Blocking Current (at case temperature of 125°C):		
Forward .....	12.5 max	ma
Reverse .....	12.5 max	ma

**SILICON CONTROLLED RECTIFIER**

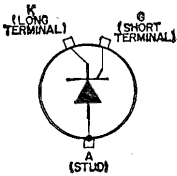

Diffused-junction n-p-n-p type used in a wide variety of power-control and power-switching applications in industrial and military equipment. This type has a maximum peak forward blocking voltage

**2N1845A**

of 150 volts and a forward-current capability of 10 amperes (average value) or 16 amperes (rms value). This type is designed to meet stringent military environmental and mechanical specifications. The special high-strength copper-alloy stud can withstand an installing torque up to 50 inch-pounds. JEDEC No. TO-48 package; outline 19, Outlines Section. This type is identical with type 2N1842A except for the following items:

**MAXIMUM RATINGS**

*For sinusoidal ac supply voltage of 50 to 400 cps, with resistive or inductive load*

Peak Reverse Voltage:		
Repetitive .....	150 max	volts
Non-repetitive (transient) .....	225 max	volts
Peak Forward Blocking Voltage (repetitive) .....	150 max	volts

**CHARACTERISTICS**

Forward Breakover Voltage (at case temperature of 125°C) .....	150 min	volts
Average Blocking Current (at case temperature of 125°C):		
Forward .....	6.5 max	ma
Reverse .....	6.5 max	ma

**SILICON CONTROLLED RECTIFIER**

**2N1846A**

Diffused-junction n-p-n-p type used in a wide variety of power-control and power-switching applications in industrial and military equipment. This type has a maximum peak forward blocking voltage

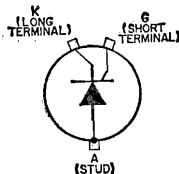

of 200 volts and a forward-current capability of 10 amperes (average value) or 16 amperes (rms value). This type is designed to meet stringent military environmental and mechanical specifications. The special high-strength copper-alloy stud can withstand an installing torque up to 50 inch-pounds. JEDEC No. TO-48 package; outline 19, Outlines Section. This type is identical with type 2N1842A except for the following items:

**MAXIMUM RATINGS**

*For sinusoidal ac supply voltage of 50 to 400 cps, with resistive or inductive load*

Peak Reverse Voltage:		
Repetitive .....	200 max	volts
Non-repetitive (transient) .....	300 max	volts
Peak Forward Blocking Voltage (repetitive) .....	200 max	volts

**CHARACTERISTICS**

Forward Breakover Voltage (at case temperature of 125°C) .....	200 min	volts
Average Blocking Current (at case temperature of 125°C):		
Forward .....	6 max	ma
Reverse .....	6 max	ma

**SILICON CONTROLLED RECTIFIER**

**2N1847A**

Diffused-junction n-p-n-p type used in a wide variety of power-control and power-switching applications in industrial and military equipment. This type has a maximum peak forward blocking voltage

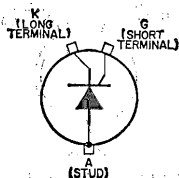

of 250 volts and a forward-current capability of 10 amperes (average value) or 16 amperes (rms value). This type is designed to meet stringent military environmental and mechanical specifications. The special high-strength copper-alloy stud can withstand an installing torque up to 50 inch-pounds. JEDEC No. TO-48 package; outline 19, Outlines Section. This type is identical with type 2N1842A except for the following items:

**MAXIMUM RATINGS**

*For sinusoidal ac supply voltage of 50 to 400 cps, with resistive or inductive load*

Peak Reverse Voltage:		
Repetitive .....	250 max	volts
Non-repetitive (transient) .....	350 max	volts
Peak Forward Blocking Voltage (repetitive) .....	250 max	volts

**CHARACTERISTICS**

Forward Breakover Voltage (at case temperature of 125°C) ....	250 min	volts
Average Blocking Current (at case temperature of 125°C):		
Forward .....	5.5 max	ma
Reverse .....	5.5 max	ma

**SILICON CONTROLLED RECTIFIER**

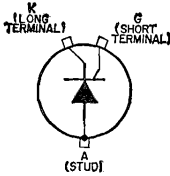

**2N1848A**

Diffused-junction n-p-n-p type used in a wide variety of power-control and power-switching applications in industrial and military equipment. This type has a maximum peak forward blocking voltage of 300 volts and a forward-current capability of 10 amperes (average value) or 16 amperes (rms value). This type is designed to meet stringent military environmental and mechanical specifications. The special high-strength copper-alloy stud can withstand an installing torque up to 50 inch-pounds. JEDEC No. TO-48 package; outline 19, Outlines Section. This type is identical with type 2N1842A except for the following items:

**MAXIMUM RATINGS**

*For sinusoidal ac supply voltage of 50 to 400 cps, with resistive or inductive load*

Peak Reverse Voltage:		
Repetitive .....	300 max	volts
Non-repetitive (transient) .....	400 max	volts
Peak Forward Blocking Voltage (repetitive) .....	300 max	volts

**CHARACTERISTICS**

Forward Breakover Voltage (at case temperature of 125°C) ....	300 min	volts
Average Blocking Current (at case temperature of 125°C):		
Forward .....	5 max	ma
Reverse .....	5 max	ma

**SILICON CONTROLLED RECTIFIER**

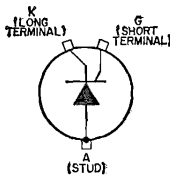

**2N1849A**

Diffused-junction n-p-n-p type used in a wide variety of power-control and power-switching applications in industrial and military equipment. This type has a maximum peak forward blocking voltage of 400 volts and a forward-current capability of 10 amperes (average value) or 16 amperes (rms value). This type is designed to meet stringent military environmental and mechanical specifications. The special high-strength copper-alloy stud can withstand an installing torque up to 50 inch-pounds. JEDEC No. TO-48 package; outline 19, Outlines Section. This type is identical with type 2N1842A except for the following items:

**MAXIMUM RATINGS**

*For sinusoidal ac supply voltage of 50 to 400 cps, with resistive or inductive load*

Peak Reverse Voltage:		
Repetitive .....	400 max	volts
Non-repetitive (transient) .....	500 max	volts
Peak Forward Blocking Voltage (repetitive) .....	400 max	volts

**CHARACTERISTICS**

Forward Breakover Voltage (at case temperature of 125°C) ....	400 min	volts
Average Blocking Current (at case temperature of 125°C):		
Forward .....	4 max	ma
Reverse .....	4 max	ma

**SILICON CONTROLLED RECTIFIER**

**2N1850A**

Diffused-junction n-p-n-p type used in a wide variety of power-control and power-switching applications in industrial and military equipment. This type has a maximum peak forward blocking voltage

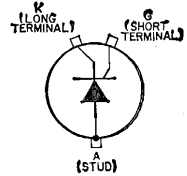

of 500 volts and a forward-current capability of 10 amperes (average value) or 16 amperes (rms value). This type is designed to meet stringent military environmental and mechanical specifications. The special high-strength copper-alloy stud can withstand an installing torque up to 50 inch-pounds. JEDEC No. TO-48 package; outline 19, Outlines Section. This type is identical with type 2N1842A except for the following items:

**MAXIMUM RATINGS**

*For sinusoidal ac supply voltage of 50 to 400 cps, with resistive or inductive load*

Peak Reverse Voltage:		
Repetitive .....	500 max	volts
Non-repetitive (transient) .....	600 max	volts
Peak Forward Blocking Voltage (repetitive) .....	500 max	volts

**CHARACTERISTICS**

Forward Breakover Voltage (at case temperature of 125°C) ....	500 min	volts
Average Blocking Current (at case temperature of 125°C):		
Forward .....	3 max	ma
Reverse .....	3 max	ma

**TRANSISTOR**

**2N1853**

Germanium p-n-p type used in high-speed switching applications in data-processing equipment. JEDEC No. TO-5 package; outline 6, Outlines Section.

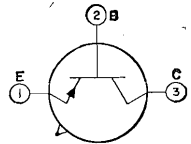

**MAXIMUM RATINGS**

Collector-to-Base Voltage (with emitter open) .....	-18 max	volts
Collector-to-Emitter Voltage (with base open) .....	-6 max	volts
Emitter-to-Base Voltage (with collector open) .....	-2 max	volts
Collector Current .....	-100 max	ma
Transistor Dissipation:		
At ambient temperatures up to 25°C .....	150 max	mw
At ambient temperatures above 25°C .....	See curve	page 80
Emitter-To-Base Dissipation (under breakdown condition with reverse bias):		
At ambient temperatures up to 25°C .....	25 max	mw
At ambient temperatures above 25°C .....	See curve	page 80
Ambient-Temperature Range:		
Operating and storage .....	-55 to 85	°C
Lead Temperature (for 10 seconds maximum) .....	235 max	°C

**CHARACTERISTICS**

Base-to-Emitter Voltage (with collector ma = -6 and base ma = -0.2) .....	-0.4 max	volt
Collector-to-Emitter Saturation Voltage (with collector ma = -6 and base ma = -0.2) .....	-0.2 max	volt
Collector-Cutoff Current (with collector-to-base volts = -15 and emitter current = 0) .....	-4.2 max	µa

*In Common-Emitter Circuit*

Forward Current-Transfer Ratio:

With collector-to-emitter volts = -1, collector current = 0, and base ma = -0.2	30 to 400
With collector-to-emitter volts = 0.4, collector ma = -6, and base current = 0	30 min

**TRANSISTOR**

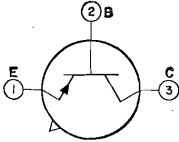

Germanium p-n-p type used in high-speed switching applications in data-processing equipment. JEDEC No. TO-5 package; outline 6, Outlines Section. This type is identical with type 2N1853 except for the

**2N1854**

following:

**CHARACTERISTICS**

Base-to-Emitter Voltage (with collector ma = -20 and base ma = -0.5)	-0.8 max	volt
Collector-to-Emitter Saturation Voltage: With collector ma = -20 and base ma = -0.66	-0.25 max	volt
With collector ma = -20 and base ma = -0.5	-0.3 max	volt

*In Common-Base Circuit*

Output Capacitance (with collector-to-base volts = -10, emitter current = 0, and frequency = 140 kilocycles)	12 max	pf
---	--------	----

*In Common-Emitter Circuit*

Forward Current-Transfer Ratio:

With collector-to-emitter voltage = -0.5 and collector ma = -20	40 min
With collector-to-emitter voltage = -0.75 and collector ma = -100	25 min
With collector-to-emitter voltage = -1 and collector ma = -50	400 max

Gain-Bandwidth Product (with collector-to-emitter volts = -1  
and collector ma = -10)

	40 min	Mc
--	--------	----

**POWER TRANSISTOR**

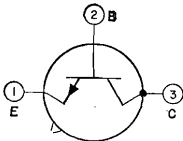

Silicon n-p-n type used in a wide variety of small-signal and medium-power switching applications in industrial and military equipment. It features high collector-to-emitter sustaining voltage, low leakage characteristics, high switching speeds, and a high dc forward current-transfer ratio.

**2N1893**

This type can be replaced by the 2N2405 in most applications. JEDEC No. TO-5 package; outline 6, Outlines Section.

**MAXIMUM RATINGS**

Collector-to-Base Voltage (with emitter open)	120 max	volt
Collector-to-Emitter Voltage (with external base-to-emitter resistance = 10 ohms or less)	100 max	volt
Collector-to-Emitter Voltage (with base open)	80 max	volt
Emitter-to-Base Voltage (with collector open)	7 max	volt
Collector Current	0.5 max	ampere
Transistor Dissipation:		
At case temperatures up to 25°C	3 max	watts
At ambient temperatures up to 25°C	0.8 max	watt
At case or ambient temperatures above 25°C	See curve page 80	
Temperature Range:		
Operating (Junction)	-65 to 200	°C
Storage	-65 to 300	°C
Lead Temperature (for 10 seconds maximum)	255 max	°C

**CHARACTERISTICS**

Collector-to-Base Breakdown Voltage (with collector ma = 0.1 and emitter current = 0)	120 min	volts
Emitter-to-Base Breakdown Voltage (with emitter ma = 0.1 and collector current = 0)	7 min	volts
Collector-to-Emitter Saturation Voltage: With base ma = 15 and collector ma = 150	5 max	volts
With base ma = 5 and collector ma = 50	1.2 max	volts
Base-to-Emitter Saturation Voltage: With base ma = 15 and collector ma = 150	1.3 max	volts
With base ma = 5 and collector ma = 50	0.9 max	volt
Collector-to-Emitter Sustaining Voltage: With base current = 0 and pulsed collector ma = 30*	80 min	volts
With external base-to-emitter resistance = 10 ohms and pulsed collector ma = 100*	100 min	volts
Collector-Cutoff Current: With case temperature = 25°C, collector-to-base volts = 90, and emitter current = 0	0.01 max	μa
With case temperature = 150°C, collector-to-base volts = 90, and emitter current = 0	15 max	μa
Emitter-Cutoff Current (with emitter-to-base volts = 5 and collector current = 0)	0.01 max	μa
Thermal Resistance: Junction-to-case	58.3 max	°C/watt
Junction-to-ambient	219 max	°C/watt

\* Pulse duration = 300 μsec, duty factor = 0.018

**TYPICAL COLLECTOR CHARACTERISTICS**

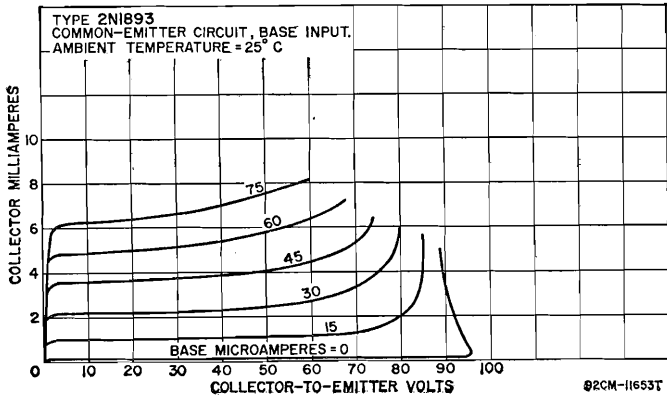

**TYPICAL TRANSFER CHARACTERISTICS**

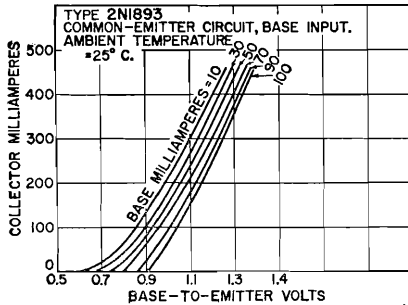



In Common-Base Circuit

Input Resistance at 1 kilocycle:		
With collector-to-base volts = 5 and collector ma = 1	20 to 30	ohms
With collector-to-base volts = 10 and collector ma = 5	4 to 8	ohms
Emitter-to-Base Capacitance (with emitter-to-base volts = 0.5 and collector current = 0)	85 max	pf
Collector-to-Base Capacitance (with collector-to-base volts = 10 and emitter current = 0)	15 max	pf
Output Conductance at 1 kilocycle:		
With collector-to-base volts = 5 and collector ma = 1	0.5 max	$\mu$ mho
With collector-to-base volts = 10 and collector ma = 5	0.5 max	$\mu$ mho
Small-Signal Open-Circuit Reverse Voltage-Transfer Ratio at 1 kilocycle:		
With collector-to-base volts = 5 and collector ma = 1	$1.25 \times 10^{-4}$	
With collector-to-base volts = 10 and collector ma = 5	$1.5 \times 10^{-4}$	

In Common-Emitter Circuit

DC Forward Current Transfer Ratio:		
With collector-to-emitter volts = 10 and pulsed collector ma = $150^*$	40 to 120	
With collector-to-emitter volts = 10 and collector ma = 10	35 min	
With collector-to-emitter volts = 10 and collector ma = 0.1	20 min	
With collector-to-emitter volts = 10, collector ma = 10, and case temperature = $-55^{\circ}\text{C}$	20 min	
Small-Signal Forward Current-Transfer Ratio:		
With collector-to-emitter volts = 5, and collector ma = 1, and frequency = 1 kilocycle	30 to 100	
With collector-to-emitter volts = 10, and collector ma = 5, and frequency = 1 kilocycle	45 min	
With collector-to-emitter volts = 10, and collector ma = 50, and frequency = 20 Mc	2.5 min	

\* Pulse duration = 300  $\mu$ sec, duty factor = 0.018

POWER TRANSISTOR

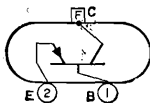

Germanium p-n-p type used in a wide variety of switching and amplifier applications. It is used as a high-power high-speed switch in dc-to-dc converters, inverters, and computers for data-processing equip-

2N1905

ment; and in ultrasonic oscillators and large-signal wide-band linear amplifiers. Package is similar to JEDEC No. TO-3; outline 24, Outlines Section. This type is identical with type 2N1906 except for typical operation and the following items:

MAXIMUM RATINGS

Collector-to-Base Voltage (with emitter open)	-60 max	volts
Collector-to-Emitter Voltage (with base open)	-40 max	volts

TYPICAL COLLECTOR CHARACTERISTICS

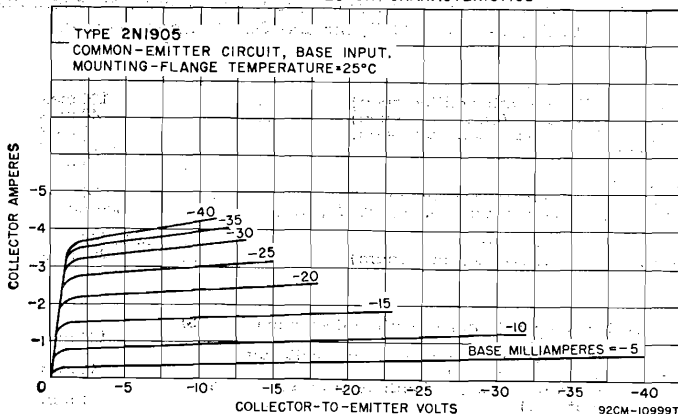

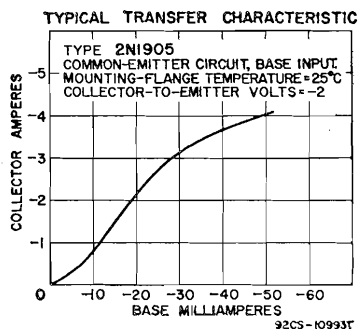
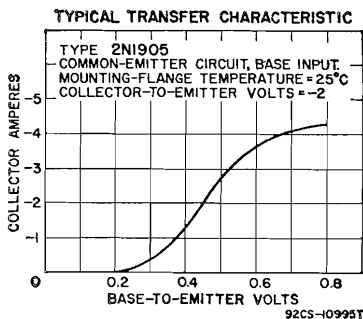

**CHARACTERISTICS**

Collector-to-Base Breakdown Voltage (with collector ma = -10 and emitter current = 0)	-60 min	volts
Collector-to-Emitter Breakdown Voltage (with collector ma = -100 and base current = 0)	-40 min	volts
Base-to-Emitter Voltage (with collector-to-emitter volts = -2 and collector ma = -1000)	-0.38	volt
Collector-to-Emitter Saturation Voltage (with collector ma = -1000 and base ma = -50)	-0.3	volt

*In Common-Emitter Circuit*

DC Forward Current-Transfer Ratio (with collector-to-emitter volts = -2 and collector ma = -1000)	50	
DC Forward Conductance (with collector-to-emitter volts = -2 and collector ma = -1000)	4	mhos

**POWER TRANSISTOR**

**2N1906**

Germanium p-n-p type used in a wide variety of switching and amplifier applications. It is used as a high-power high-speed switch in dc-to-dc converters, inverters, and computers for data-processing equip-

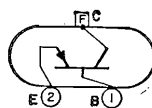

ment; and in ultrasonic oscillators and large-signal wide-band linear amplifiers. Package is similar to JEDEC No. TO-3; outline 24, Outlines Section.

**MAXIMUM RATINGS**

Collector-to-Base Voltage (with emitter open)	-100 max	volts
Collector-to-Emitter Voltage (with base open)	-40 max	volts
Emitter-to-Base Voltage (with collector open)	-1 max	volt
Collector Current	-10 max	amperes
Base Current	-3 max	amperes
Transistor Dissipation:		
For mounting-flange temperatures up to 25°C	50 max	watts
For mounting-flange temperatures above 25°C	See curve	page 80
Temperature Range:		
Operating (junction) and storage	-55 to 100	°C
Lead Temperature (for 10 seconds maximum)	255 max	°C

**CHARACTERISTICS**

Collector-to-Base Breakdown Voltage (with collector ma = -10 and emitter current = 0)	100 min	volts
Collector-to-Emitter Breakdown Voltage (with collector ma = -100 and base current = 0)	40 min	volts
Emitter-to-Base Breakdown Voltage (with emitter ma = -5 and collector current = 0)	1 min	volt

TYPICAL COLLECTOR CHARACTERISTICS

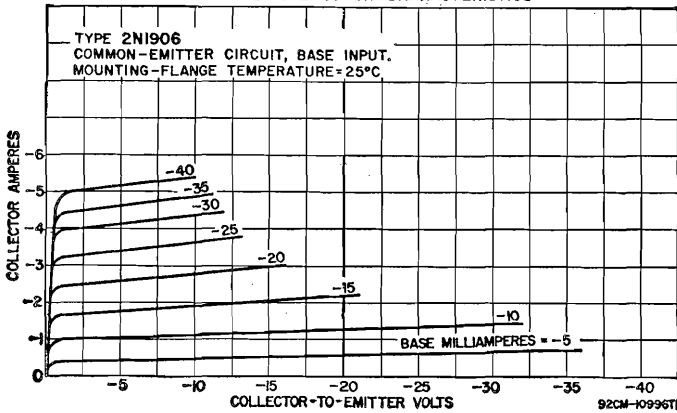

TYPICAL TRANSFER CHARACTERISTIC

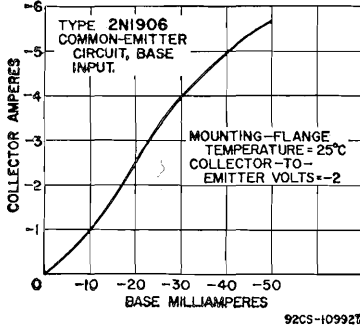

TYPICAL TRANSFER CHARACTERISTIC

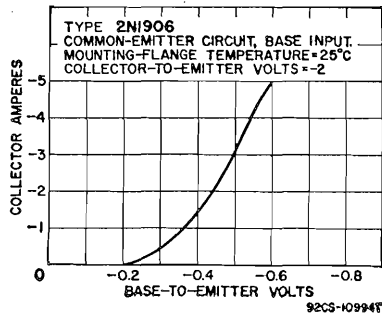

Base-to-Emitter Voltage (with collector-to-emitter volts = -2 and collector ma = -5000)	-0.6	volt
Collector-to-Emitter Saturation Voltage (with collector ma = -5000 and base ma = -250)	-0.75	volt
Collector-Cutoff Current (with collector-to-base volts = -40 and emitter current = 0)	-150	μa
Collector-Cutoff Saturation Current (with collector-to-base volts = -0.5 and emitter current = 0)	-65	μa
Emitter-Cutoff Current (with emitter-to-base volts = -0.5 and collector current = 0)	-1	ma
Thermal Resistance:		
Junction-to-mounting flange	1.5 max	°C/watt

In Common-Emitter Circuit

DC Forward Current-Transfer Ratio (with collector-to-emitter volts = -2 and collector ma = -5000)	125	
Small-Signal Forward-Current-Transfer-Ratio Cutoff Frequency (with collector-to-emitter volts = -5 and collector ma = -500)	75	kc
Gain-Bandwidth Product (with collector-to-emitter volts = -5 and collector ma = -500)	7.5	Mc
DC Forward Conductance (with collector-to-emitter volts = -2 and collector ma = -5000)	8.3	mhos

TYPICAL OPERATION IN "ON-OFF" POWER-SWITCHING CIRCUIT

DC Collector-Supply Voltage	5	12.5	12.5	volts
On DC Collector Current	-1	-2.5	-5	amperes
Turn-On DC Base Current	-	-0.25	-0.25	ampere
Turn-Off DC Base Current	-	0.25	0.25	ampere

Pulse-Generator Open-Circuit Voltage	2	—	—	volts
Base-Bias Resistor	75	5	5	ohms
"Speed-Up" Capacitor	0.1	—	—	$\mu$ f
Load Resistor	5	5	2.5	ohms
Generator Impedance	5	5	5	ohms
Switching Time:				
Delay time	0.1	0.1	0.1	$\mu$ sec
Rise time	0.1	0.4	0.9	$\mu$ sec
Storage time	1	7	7	$\mu$ sec
Fall time	0.6	1	2	$\mu$ sec

**POWER TRANSISTOR**

**2N2015**

Silicon n-p-n type used in a wide variety of high-power switching and amplifier applications in industrial and military equipment. It is used in power-switching, dc-to-dc converter, inverter, chopper, sole-

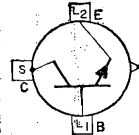

noid and relay control circuits; in oscillator, regulator, and pulse-amplifier circuits; and as a class A or class B push-pull audio and servo amplifier. It features low saturation resistance, high current and power dissipation, high beta at high current, and excellent high-temperature performance. JEDEC No. TO-36 package; outline 14, Outlines Section. This type is identical with type 2N2016 except for the following:

**MAXIMUM RATINGS**

Collector-to-Base Voltage (with emitter open)	100 max	volts
Collector-to-Emitter Voltage (with base open)	50 max	volts

**CHARACTERISTICS**

Collector-to-Emitter Voltage:		
With emitter-to-base volts = -1.5 and collector ma = 2	100 min	volts
With base open and collector ma = 200	50 min	volts
Collector-Cutoff Current (with collector-to-emitter volts = 100 and base-to-emitter volts = -1.5)	2 max	ma
Collector-to-Emitter Sustaining Voltage (with collector amperes = 0.2 and base current = 0)	50 min	volts

**POWER TRANSISTOR**

**2N2016**

Silicon n-p-n type used in a wide variety of high-power switching and amplifier applications in industrial and military equipment. It is used in power-switching, dc-to-dc converter, inverter, chopper, sole-

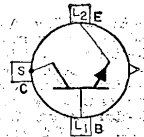

noid and relay control circuits; in oscillator, regulator, and pulse-amplifier circuits; and as a class A or class B push-pull audio and servo amplifier. It features low saturation resistance, high current and power dissipation, high beta at high current, and excellent high-temperature performance. JEDEC No. TO-36 package; outline 14, Outlines Section.

**MAXIMUM RATINGS**

Collector-to-Base Voltage (with emitter open)	130 max	volts
Collector-to-Emitter Voltage (with base open)	65 max	volts
Emitter-to-Base Voltage (with collector open)	10 max	volts
Collector Current	10 max	amperes
Base Current	6 max	amperes
Emitter Current	-13 max	amperes
Transistor Dissipation:		
At case temperatures up to 25°C	150 max	watts
At case temperatures above 25°C	See curve	page 80
Temperature Range:		
Operating (Junction) and Storage	-65 to 200	°C

**CHARACTERISTICS**

Collector-to-Emitter Voltage: With emitter-to-base volts = -1.5 and collector ma = 2 .....	130 min	volts
With base open and collector ma = 200 .....	65 min	volts
Collector-to-Emitter Sustaining Voltage (with collector ma = 200 and base current = 0) .....	65 min	volts
Collector-to-Emitter Saturation Voltage (with collector amperes = 5 and base ampere = 0.5) .....	1.25 max	volts
Base-to-Emitter Voltage (with collector-to-emitter volts = 5 and collector amperes = 5) .....	2.2 max	volts
Collector-Cutoff Current: With collector-to-emitter volts = 30, base-to-emitter volts = -1.5, and case temperature = 150°C .....	2 max	ma
With collector-to-emitter volts = 130, base-to-emitter volts = -1.5, and case temperature = 25°C .....	2 max	ma
Emitter-Cutoff Current (with emitter-to-base volts = 10 and collector current = 0) .....	0.05 max	ma
Thermal Resistance: Junction-to-case .....	1.17 max	°C/watt
Thermal Time Constant .....	30	msec

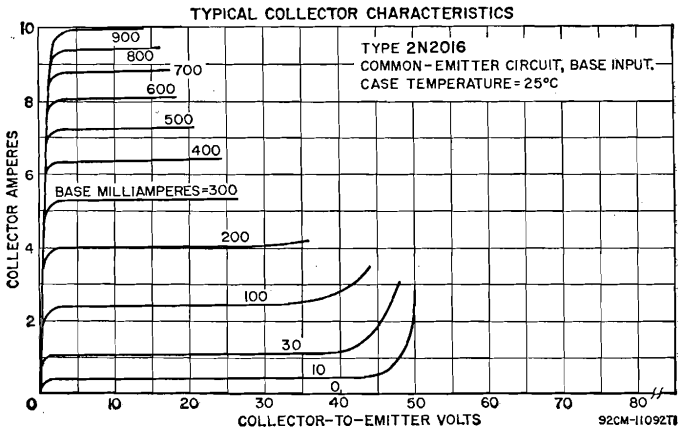

**In Common-Base Circuit**

Collector-to-Base Capacitance (with collector-to-base volts = 40, collector $\mu$ a = 50, and frequency = 1 Mc) .....	400 max	pf
--	---------	----

**In Common-Emitter Circuit**

DC Forward Current-Transfer Ratio: With collector-to-emitter volts = 4 and collector amperes = 9 .....	8 min	
With collector-to-emitter volts = 4 and collector amperes = 5 .....	15 to 50	
Small-Signal Forward Current-Transfer Ratio (with collector- to-emitter volts = 4, collector ampere = 1, and frequency = 1 kilocycle) .....	12 to 60	
Small-Signal Forward-Current-Transfer-Ratio Cutoff Frequency (with collector-to-emitter volts = 4 and collector amperes = 5) .....	12 min	kc

**TYPICAL OPERATION IN PULSE-RESPONSE TEST CIRCUIT**

DC Collector-Supply Voltage ( $V_{CC}$ ) .....	24	volts
DC Base-Supply Voltage ( $V_{BB}$ ) .....	-6	volts
On DC Collector Current ( $I_C$ ) .....	10	amperes
Turn-On DC Base Current ( $I_{B1}$ ) .....	2	amperes
Base-Circuit Resistance ( $R_{B1}$ or $R_{B2}$ ) .....	10	ohms
Collector-Circuit Resistance ( $R_C$ ) .....	2	ohms
Switching Time: On time (Delay time $t_d$ plus rise time $t_r$ ) .....	4	$\mu$ sec
Off time (Storage time $t_s$ plus fall time $t_f$ ) .....	7	$\mu$ sec

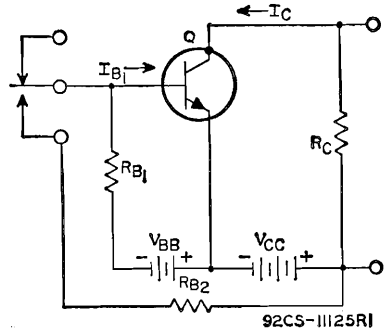
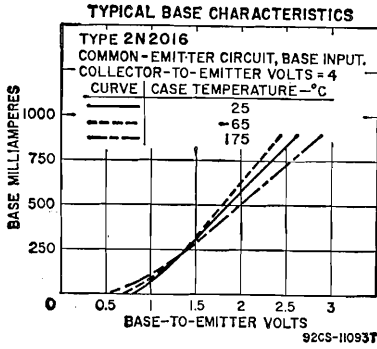

**TRANSISTOR**

**2N2102**

Silicon n-p-n type used in a wide variety of small-signal and medium-power applications in industrial and military equipment. It can be used in rf service as an amplifier, mixer, oscillator, and con-

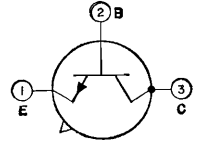

verter; in af service for small- and large-signal driver and power applications; in switching service for high-speed switching circuits requiring transistors having high voltage and current values. It features low saturation voltage, high sustaining voltage, high dissipation, high pulse beta, low output capacitance, and exceptionally low noise and leakage characteristics. JEDEC No. TO-5 package; outline 6, Outlines Section.

**MAXIMUM RATINGS**

Collector-to-Base Voltage (with emitter open)	120 max	volts
Collector-to-Emitter Voltage:		
With external base-to-emitter resistance = 10 ohms or less	80 max	volts
With base open	65 max	volts
Emitter-to-Base Voltage (with collector open)	7 max	volts
Collector Current	1 max	ampere
Transistor Dissipation:		
At case temperatures up to 25°C	5 max	watts
At ambient temperatures up to 25°C	1 max	watt
At case or ambient temperatures above 25°C	See curve	page 80
Temperature Range:		
Operating (junction)	-65 to 200	°C
Storage	-65 to 300	°C
Lead Temperature (for 10 seconds maximum)	300 max	°C

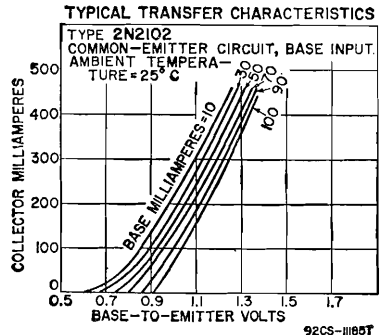
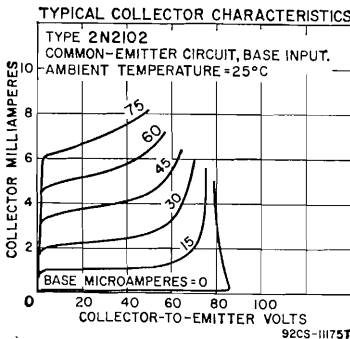

**CHARACTERISTICS**

Collector-to-Base Breakdown Voltage (with collector $i_a = 0.1$ and emitter current = 0)	120 min	volts
Emitter-to-Base Breakdown Voltage (with emitter $i_a = 0.1$ and collector current = 0)	7 min	volts
Collector-to-Emitter Reach-Through Voltage (with emitter-to-base volts = 1.5 and collector $i_a = 0.1$ )	120 min	volts
Collector-to-Emitter Sustaining Voltage:		
With external base-to-emitter resistance = 10 ohms or less and collector $i_a = 100$	80 min	volts
With collector $i_a = 100$ and base current = 0	65 min	volts
Base-to-Emitter Saturation Voltage (with collector $i_a = 150$ and base $i_a = 15$ )	1.1 max	volts
Collector-to-Emitter Saturation Voltage (with collector $i_a = 150$ and base $i_a = 15$ )	0.5 max	volt
Collector-Cutoff Current (with collector-to-base volts = 60 and emitter current = 0)	0.002 max	$\mu a$
Emitter-Cutoff Current (with emitter-to-base volts = 5 and collector current = 0)	0.002 max	$\mu a$
Thermal Resistance:		
Junction-to-case	35 max	$^{\circ}C/watt$
Junction-to-ambient	175 max	$^{\circ}C/watt$

**In Common-Base Circuit**

Input Resistance at 1 kilocycle:		
With collector-to-base volts = 5 and collector $i_a = 1$	24 to 34	ohms
With collector-to-base volts = 10 and collector $i_a = 5$	4 to 8	ohms
Input Capacitance (with emitter-to-base volts = 0.5 and collector current = 0)	80 max	pf
Output Capacitance (with collector-to-base volts = 10 and emitter current = 0)	15 max	pf
Output Conductance at 1 kilocycle:		
With collector-to-base volts = 5 and collector $i_a = 1$	0.1 to 0.5	$\mu mho$
With collector-to-base volts = 10 and collector $i_a = 5$	0.1 to 1	$\mu mho$
Small-Signal Open-Circuit Reverse Voltage-Transfer Ratio at 1 kilocycle:		
With collector-to-base volts = 5 and collector $i_a = 1$	0.0003 max	
With collector-to-base volts = 10 and collector $i_a = 5$	0.0003 max	

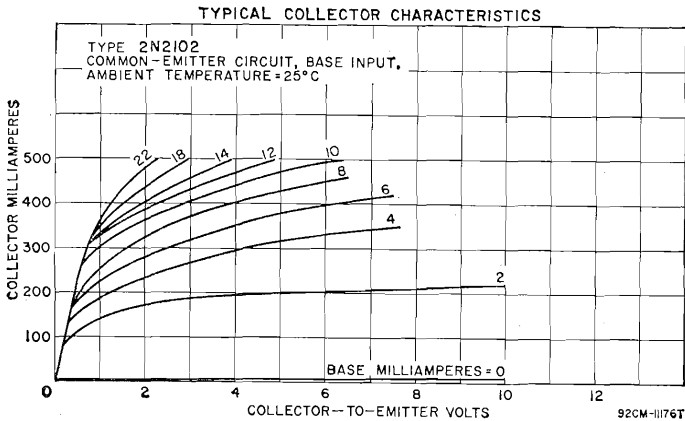

**In Common-Emitter Circuit**

DC-Pulse Forward Current-Transfer Ratio:*	
With collector-to-emitter volts = 10 and collector $i_a = 150$	40 to 120
With collector-to-emitter volts = 10 and collector $i_a = 500$	25 min
With collector-to-emitter volts = 10 and collector $i_a = 1000$	10 min
DC Forward Current-Transfer Ratio:	
With collector-to-emitter volts = 10 and collector $i_a = 0.01$	10 min
With collector-to-emitter volts = 10 and collector $i_a = 0.1$	20 min
With collector-to-emitter volts = 10 and collector $i_a = 1$	35 min

**Small-Signal Forward Current-Transfer Ratio:**

With collector-to-emitter volts = 5, collector ma = 1, and frequency = 1 kilocycle	30 to 100	
With collector-to-emitter volts = 10, collector ma = 5, and frequency = 1 kilocycle	35 to 150	
With collector-to-emitter volts = 10, collector ma = 50, and frequency = 20 Mc		3 min
Noise Figure (with collector-to-emitter volts = 10, collector ma = 0.3, generator resistance = 1000 ohms, circuit bandwidth = 15 kilocycles, and signal frequency = 1 kilocycle)	6 max	db
Total Switching Time† (delay time plus rise time plus fall time)	30 max	nsec

\* Pulse duration = 300  $\mu$ sec, duty factor = 0.018.

† See Total-Switching-Time Measurement Circuit below.

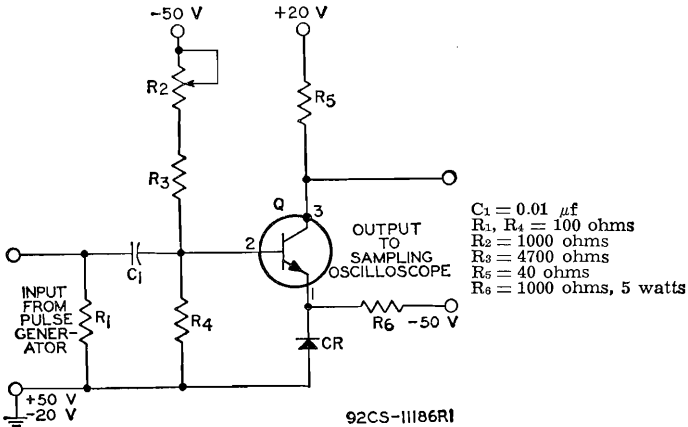

**POWER TRANSISTOR**

**2N2147**

Germanium p-n-p type used in high-fidelity amplifiers and other af amplifiers where wide frequency range and low distortion are required. It is intended primarily for class B amplifier service. JEDEC No.

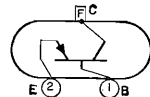

TO-3 package; outline 5, Outlines Section.

**MAXIMUM RATINGS**

Collector-to-Base Voltage	-75 max	volts
Collector-to-Emitter Voltage	-50 max	volts
Emitter-to-Base Voltage	-1.5 max	volts
Collector Current	-5 max	amperes
Base Current	-1 max	ampere
Emitter Current	5 max	amperes
Transistor Dissipation:		
At mounting-flange temperatures up to 81°C	12.5 max	watts
At mounting-flange temperatures above 81°C	Derate 0.66	watt/°C
Temperature Range:		
Operating (junction) and Storage	-65 to 100	°C
Lead Temperature (for 10 seconds maximum)	255 max	°C

**CHARACTERISTICS**

Collector-to-Base Breakdown Voltage (with collector ma = -10 and emitter current = 0)	-75 min	volts
Collector-to-Emitter Breakdown Voltage (with collector ma = -100 and base current = 0)	-50 min	volts
Base-to-Emitter Voltage (with collector-to-emitter volts = -10 and collector ma = -50)	-0.24	volt
Collector-Cutoff Current (with collector-to-base volts = -40 and emitter current = 0)	-1 max	ma



Collector-Cutoff Saturation Current (with collector-to-base volt = -0.5 and emitter current = 0) .....	-70 max	$\mu$ a
Emitter-Cutoff Current (with emitter-to-base volts = -1.5 and collector current = 0) .....	-2.5 max	ma
Thermal Resistance:		
Junction-to-case .....	1.5 max	$^{\circ}$ C/watt

**In Common-Emitter Circuit**

DC Forward Current-Transfer Ratio (with collector-to-emitter volts = -1 and collector ma = -1000) .....	150	
Gain-Bandwidth Product (with collector-to-emitter volts = -5 and collector ma = -500) .....	4	Mc

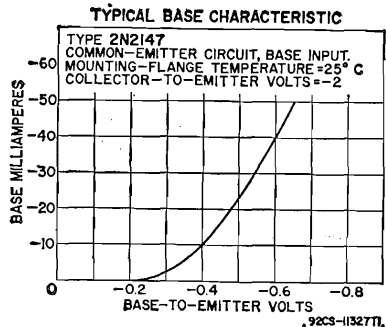
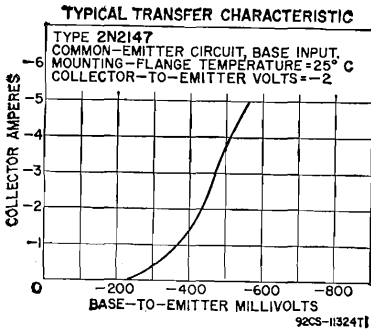
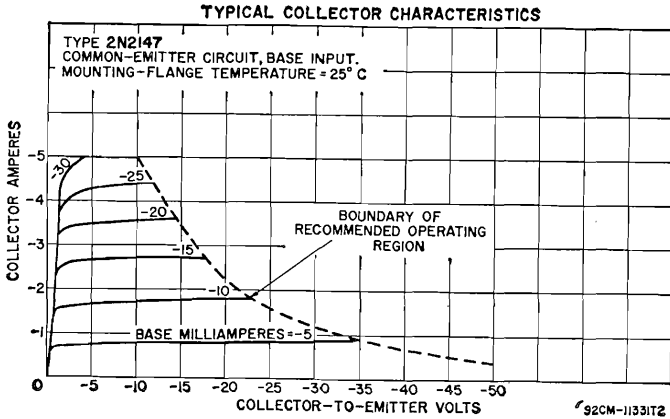

**TYPICAL OPERATION IN SINGLE-ENDED PUSH-PULL AMPLIFIER CIRCUIT**

DC Collector Supply Voltage .....	22	volts
Zero-Signal DC Collector Current .....	-0.05	ampere
Zero-Signal Base-Bias Voltage .....	-0.24	volt
Peak Collector Current .....	-3.5	amperes
Maximum-Signal DC Collector Current .....	-1.1	amperes
Input Impedance of Stage (per base) .....	75	ohms
Load Impedance (Speaker Voice Coil) .....	4	ohms

Power Gain .....	33	db
Maximum-Signal Power Output .....	25	watts
Total Harmonic Distortion at Maximum Signal Power Output ..	5	per cent
Maximum Collector Dissipation (per transistor) under worst-case conditions .....	12.5	watts
EIA Music Power Output Rating .....	45	watts

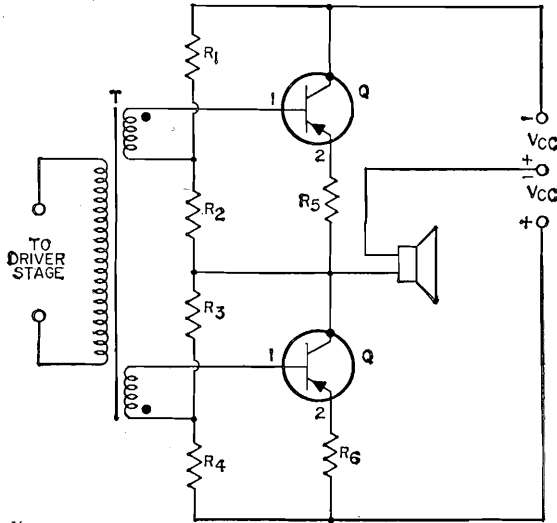

- $V_{cc} = 22$  volts
- $R_1, R_3 = 330$  ohms, 2 watts
- $R_2, R_4 = 3.9$  ohms, 0.5 watt
- $R_5, R_6 = 0.27$  ohm, 0.5 watt
- Voice coil impedance = 4 ohms

92CS-11332R2

### POWER TRANSISTOR

## 2N2148

Germanium p-n-p type used in high-fidelity amplifiers and other af amplifiers where wide frequency range and low distortion are required. It is intended primarily for use as a class A power amplifier

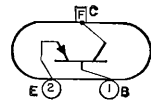

in driver stages of high-power, high-quality af amplifiers, and in the output stages of moderate-power amplifiers. It can also be used in class B power-amplifier circuit. JEDEC No. TO-3 package; outline 5, Outlines Section.

#### MAXIMUM RATINGS

Collector-to-Base Voltage .....	-60 max	volts
Collector-to-Emitter Voltage .....	-40 max	volts
Emitter-to-Base Voltage .....	-1.5 max	volts
Collector Current .....	-5 max	amperes
Base Current .....	-1 max	ampere
Emitter Current .....	5 max	amperes
Transistor Dissipation:		
At mounting-flange temperatures up to 81°C .....	12.5 max	watts
At mounting-flange temperatures above 81°C .....	Derate 0.66 watt/°C	
Temperature Range:		
Operating (junction) and Storage .....	-65 to 100	°C
Lead Temperature (for 10 seconds maximum) .....	255 max	°C

**CHARACTERISTICS**

Collector-to-Base Breakdown Voltage (with collector ma = -10 and emitter current = 0)	-60 min	volts
Collector-to-Emitter Breakdown Voltage (with collector ma = -100 and base current = 0)	-40 min	volts
Base-to-Emitter Voltage (with collector-to-emitter volts = -10 and collector ma = -50)	-0.26	volt
Collector-Cutoff Current (with collector-to-base volts = -40 and emitter current = 0)	-1 max	ma
Collector-Cutoff Saturation Current (with collector-to-base volt = -0.5 and emitter current = 0)	-100 max	ma
Emitter-Cutoff Current (with emitter-to-base volts = -1.5 and collector current = 0)	-10 max	ma
Thermal Resistance:		
Junction-to-case	1.5 max	°C/watt

**In Common-Emitter Circuit**

DC Forward Current-Transfer Ratio (with collector-to-emitter volts = -1 and collector ma = -1000)	100	
Gain-Bandwidth Product (with collector-to-emitter volts = -5 and collector ma = -500)	3	Mc

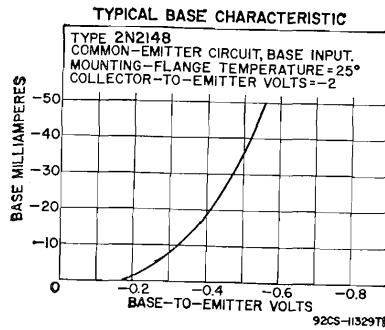
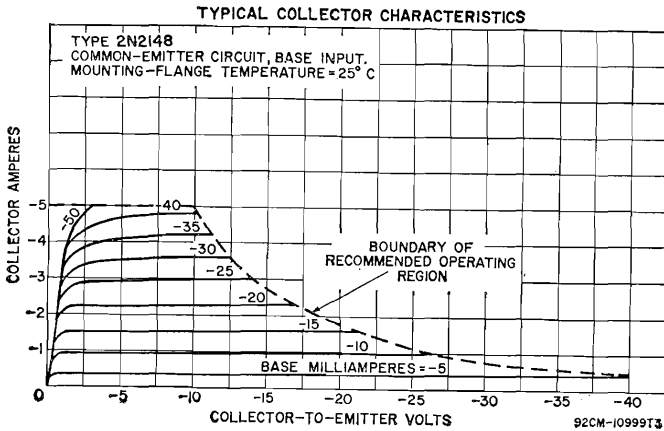

**TYPICAL OPERATION IN SINGLE-ENDED PUSH-PULL AMPLIFIER CIRCUIT**

DC Collector Supply Voltage	16.5	volts
Zero-Signal DC Collector Current	-0.05	ampere
Zero-Signal Base-Bias Voltage	-0.26	volt
Peak Collector Current	-2.7	amperes
Maximum-Signal DC Collector Current	-0.85	ampere

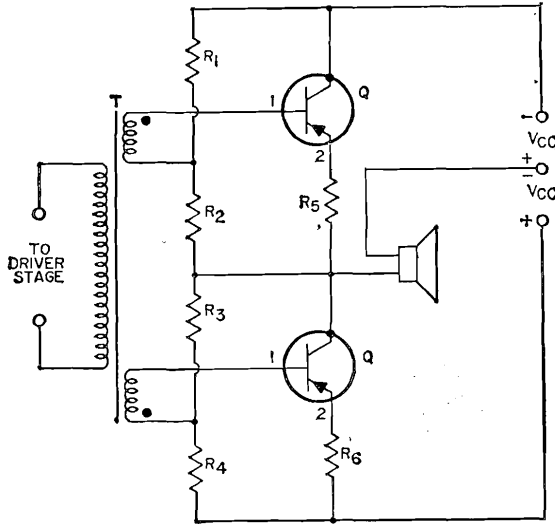

92CS-11332R2

$V_{CC} = 16.5$  volts  
 $R_1, R_3 = 270$  ohms, 2 watts  
 $R_2, R_4 = 3.9$  ohms, 0.5 watt  
 $R_5, R_6 = 0.39$  ohm, 0.5 watt  
 Voice coil  
 impedance = 4 ohms

Input Impedance of Stage (per base) .....	65	ohms
Load Impedance (Speaker Voice Coil) .....	4	ohms
Power Gain .....	31	db
Maximum-Signal Power Output .....	15	watts
Total Harmonic Distortion at Maximum Signal Power Output .....	5	per cent
Maximum Collector Dissipation (per transistor) under worst-case conditions .....	7.5	watts
EIA Music Power Output Rating .....	25	watts

### TRANSISTOR

## 2N2205

Silicon n-p-n type used in very-high-speed switching applications in equipments which require high reliability and high packaging densities. JEDEC No. TO-18 package; outline 12, Outlines Section.

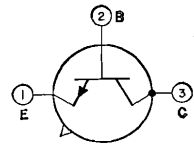

type is electrically identical with type 2N1708 except for the following item:

### CHARACTERISTICS

Emitter-Cutoff Current (with emitter-to-base volts = 3 and collector current = 0) .....	100 max	$\mu$ a
---	---------	---------

### TRANSISTOR

## 2N2206

Silicon n-p-n type used in very-high-speed switching applications in equipments which require high reliability and high packaging densities. JEDEC No. TO-46 package; outline 18, Outlines Section.

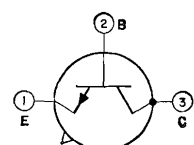

**MAXIMUM RATINGS**

Collector-to-Base Voltage (with emitter open)	25 max	volts
Collector-to-Emitter Voltage (with external base-to-emitter resistance = 1000 ohms and load resistance = 100 ohms)	20 max	volts
Emitter-to-Base Voltage (with collector open)	3 max	volts
Collector Current	0.2 max	ampere
Transistor Dissipation:		
At case temperatures up to 25°C	1 max	watt
At ambient temperatures up to 25°C	0.3 max	watt
At case or ambient temperatures above 25°C	See curve	page 80
Temperature Range:		
Operation (junction)	-65 to 175	°C
Storage	-65 to 300	°C
Lead Temperature (for 10 seconds maximum)	235 max	°C

**CHARACTERISTICS**

Base-to-Emitter Saturation Voltage (with collector ma = 10 and base ma = 1)	0.7 to 0.9	volt
Collector-to-Emitter Saturation Voltage:		
With collector ma = 10 and base ma = 1	0.22 max	volt
With collector ma = 50 and base ma = 5	0.35 max	volt
Collector-Cutoff Current (with collector-to-base volts = 15 and emitter current = 0)	0.025 max	μa

*In Common-Base Circuit*

Collector-to-Base Capacitance (with collector-to-base volts = 10, emitter current = 0, and frequency = 140 kilocycles)	6 max	pf
--	-------	----

*In Common-Emitter Circuit*

DC Forward Current-Transfer Ratio (with collector-to-emitter volts = 1 and collector ma = 10)	40 to 120
Small-Signal Forward Current-Transfer Ratio (with collector-to-emitter volts = 10, collector ma = 10, and frequency = 100 Mc)	2 min

**TRANSISTOR**

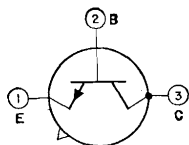

Silicon n-p-n type used in a wide variety of small-signal and medium-power applications in industrial and military equipment. It can be used in rf service as an amplifier, mixer, oscillator and converter;

**2N2270**

in af service in small-signal and power applications. It features low output capacitance and exceptionally low noise and leakage characteristics. JEDEC No. TO-5 package; outline 6, Outlines Section. For curve of collector characteristics, refer to type 2N2102.

**MAXIMUM RATINGS**

Collector-to-Base Voltage (with emitter open)	60 max	volts
Collector-to-Emitter Voltage:		
With external base-to-emitter resistance = 10 ohms or less	60 max	volts
With base open	45 max	volts
Emitter-to-Base Voltage (with collector open)	7 max	volts
Collector Current	1 max	ampere
Transistor Dissipation:		
At case temperatures up to 25°C	5 max	watts
At ambient temperatures up to 25°C	1 max	watt
At case or ambient temperatures above 25°C	See curve	page 80
Temperature Range:		
Operating (junction) and storage	-65 to 200	°C
Lead Temperature (for 10 seconds maximum)	255 max	°C

**CHARACTERISTICS**

Collector-to-Base Breakdown Voltage (with collector ma = 0.1 and emitter current = 0)	60 min	volts
Emitter-to-Base Breakdown Voltage (with emitter ma = 0.1 and collector current = 0)	7 min	volts

**Collector-to-Emitter Sustaining Voltage:**

With external base-to-emitter resistance = 10 ohms or less and pulse collector ma = 100*	60 min	volts
With pulse collector ma = 100* and base current = 0	45 min	volts
Base-to-Emitter Saturation Voltage (with collector ma = 150 and base ma = 15)	1.2 max	volts
Collector-to-Emitter Saturation Voltage (with collector ma = 150 and base ma = 15)	0.9 max	volt
Collector-Cutoff Current (with collector-to-base volts = 60 and emitter current = 0)	0.1 max	$\mu$ a
Emitter-Cutoff Current (with emitter-to-base volts = 5 and collector current = 0)	0.1 max	$\mu$ a
Thermal Resistance:		
Junction-to-case	35 max	$^{\circ}$ C/watt
Junction-to-ambient	175 max	$^{\circ}$ C/watt

**In Common-Base Circuit**

Input Capacitance (with emitter-to-base volts = 0.5 and collector current = 0)	80 max	pf
Output Capacitance (with collector-to-base volts = 10 and emitter current = 0)	15 max	pf

**In Common-Emitter Circuit**

**DC Forward Current-Transfer Ratio:**

With collector-to-emitter volts = 10 and pulse collector ma* = 150	50 to 200	
With collector-to-emitter volts = 10 and collector ma = 1	35 min	

**Small-Signal Forward Current-Transfer Ratio:**

With collector-to-emitter volts = 10, collector ma = 5, and frequency = 1 kilocycle	30 to 180	
With collector-to-emitter volts = 10, collector ma = 5, and frequency = 20 Mc	3 min	

Noise Figure (with collector-to-emitter volts = 10, collector ma = 0.3, generator resistance = 1000 ohms, circuit bandwidth = 15 kilocycles, and signal frequency = 1 kilocycle)	6 max	db
--	-------	----

\* Pulse duration = 300  $\mu$ sec, duty factor = 0.018.

**TRANSISTOR**

**2N2273**

Germanium p-n-p type used for low-power radio-frequency amplifier applications in the vhf range in industrial and military equipment. JEDEC No. TO-18 package; outline 12, Outlines Section.

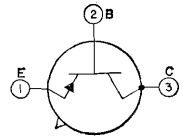

**MAXIMUM RATINGS**

Collector-to-Base Voltage (with emitter open)	-25 max	volts
Collector-to-Emitter Voltage (with base open)	-15 max	volts
Emitter-to-Base Voltage (with collector open)	-1 max	ma
Collector Current	-100 max	ma
Transistor Dissipation:		
At ambient temperatures up to 25 $^{\circ}$ C	100 max	mw
At ambient temperatures above 25 $^{\circ}$ C	See curve	page 80
Temperature Range:		
Operating (junction) and storage	-65 to 100	$^{\circ}$ C
Lead Temperature (for 10 seconds maximum)	235 max	$^{\circ}$ C

**CHARACTERISTICS**

Collector-to-Base Breakdown Voltage (with collector ma = 0.1 and emitter current = 0)	-25 min	volts
Collector-to-Emitter Breakdown Voltage (with collector ma = 0.1 and base current = 0)	-15 min	volts
Emitter-to-Base Breakdown Voltage (with emitter ma = 0.1 and collector current = 0)	-1 min	volt
Collector-Cutoff Current (with collector-to-base volts = -12 and emitter current = 0)	-10 max	$\mu$ a

**In Common-Base Circuit**

Output Capacitance (with collector-to-base volts = -10, emitter current = 0, and frequency = 140 kilocycles)	3.5 max	pf
--	---------	----

**In Common-Emitter Circuit**

DC Forward Current-Transfer Ratio (with collector-to-emitter volts = -10 and collector ma = -1)	20 to 150	
Small-Signal Forward Current-Transfer Ratio (with collector-to-emitter volts = -6, collector ma = -1, and frequency = 10 Mc)	20 to 28	
Base Spreading Resistance (with collector-to-emitter volts = -10, collector ma = -1, and frequency = 250 Mc)	250	ohms
High-Frequency Input Impedance (with collector-to-emitter volts = -9, collector ma = -1, and frequency = 250 Mc)	50 to 250	ohms
Small-Signal Power Gain (with collector-to-emitter volts = -9, collector ma = -1, and frequency = 30 Mc)	10 min	db

**POWER TRANSISTOR**

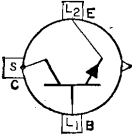

Silicon n-p-n type used in a wide variety of switching and amplifier applications in industrial equipment. It is used in power-switching, dc-to-dc converter, inverter, chopper, and relay-control

**2N2338**

circuits; in oscillator, voltage- and current-regulator circuits; and in dc and servo amplifier circuits. JEDEC No. TO-36 package; outline 14, Outlines Section.

**MAXIMUM RATINGS**

Collector-to-Base Voltage (with emitter open)	60 max	volts
Collector-to-Emitter Voltage:		
With emitter-to-base volts = 1.5	60 max	volts
With base open	40 max	volts
Emitter-to-Base Voltage (with collector open)	6 max	volts
Collector Current	7.5 max	amperes
Base Current	5 max	amperes
Transistor Dissipation:		
At case temperatures up to 25°C	150 max	watts
At case temperatures above 25°C	See curve	page 80
Temperature Range:		
Operating (junction) and storage	-65 to 200	°C

**CHARACTERISTICS**

Collector-to-Emitter Voltage (with emitter-to-base volts = 1.5 and collector ma = 2)	60 min	volts
Collector-to-Emitter Sustaining Voltage (with base open and collector ma = 200)	40 min	volts
Base-to-Emitter Voltage (with collector-to-emitter volts = 4 and collector amperes = 3)	3 max	volts
Collector-to-Emitter Saturation Voltage:		
With collector amperes = 6 and base ampere = 1	3.5 max	volts
With collector amperes = 3 and base ampere = 0.3	1.5 max	volts
Emitter-Cutoff Current:		
With collector-to-emitter volts = 30 and base current = 0	5 max	ma
With collector-to-emitter volts = 60 and base-to-emitter volts = -1.5	2 max	ma
With collector-to-emitter volts = 30, base-to-emitter volts = -1.5, and case temperature = 200°C	50 max	ma
With collector-to-base volts = 30, emitter current = 0, and case temperature = 25°C	0.2 max	ma
150°C	3 max	ma
Emitter-Cutoff Current (with emitter-to-base volts = 6 and collector current = 0)	0.1 max	ma
Thermal Time Constant	30	msec
Thermal Resistance:		
Junction-to-case	1.17 max	°C/watt

**In Common-Base Circuit**

Collector-to-Base Capacitance (with collector-to-base volts = 40, emitter current = 0, and frequency = 0.1 Mc)	600 max	pf
--	---------	----

**In Common-Emitter Circuit**

DC Forward Current-Transfer Ratio:		
With collector-to-emitter volts = 4 and collector amperes = 3	15 to 60	
With collector-to-emitter volts = 4 and collector amperes = 6	7 min	

Small-Signal Forward Current-Transfer Ratio (with collector-to-emitter volts = 4, collector ampere = 0.5, and frequency = 1 kilocycle) .....

12 to 72

Small-Signal Forward-Current-Transfer-Ratio Cutoff Frequency (with collector-to-emitter volts = 4 and collector ampers = 5) .....

15 min kc

Collector-to-Emitter Saturation Resistance (with collector amperes = 3 and base ampere = 0.3) .....

0.5 max ohm

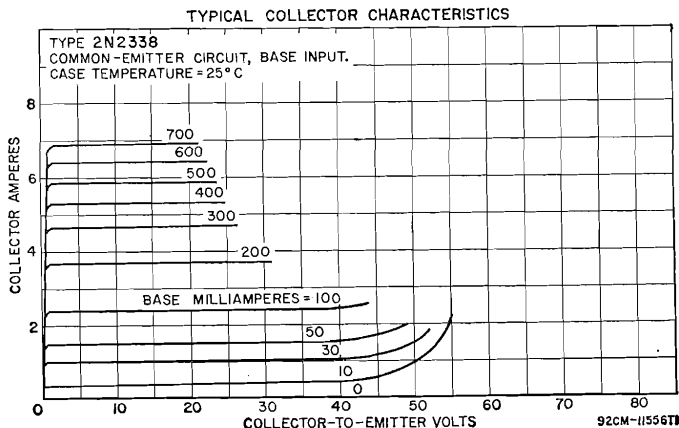

**TYPICAL OPERATION IN PULSE-RESPONSE TEST CIRCUIT BELOW**

DC Collector Supply Voltage ( $V_{CC}$ ) .....	24	volts
DC Base Supply Voltage ( $V_{BB}$ ) .....	-6	volts
On DC Collector Current ( $I_C$ ) .....	10	amperes
Turn-On DC Base Current ( $I_{B1}$ ) .....	2	amperes
Base-Circuit Resistance ( $R_{B1}$ or $R_{B2}$ ) .....	10	ohms
Collector-Circuit Resistance ( $R_C$ ) .....	2	ohms
Switching Time:		
On time (Delay time $t_d$ plus rise time $t_r$ ) .....	4	$\mu$ sec
Off time (Storage time $t_s$ plus fall time $t_f$ ) .....	7	$\mu$ sec

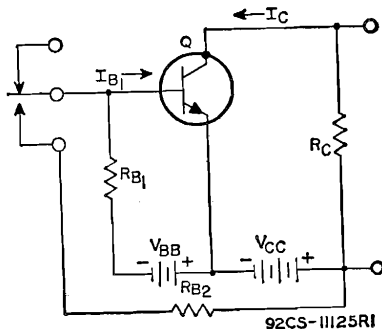
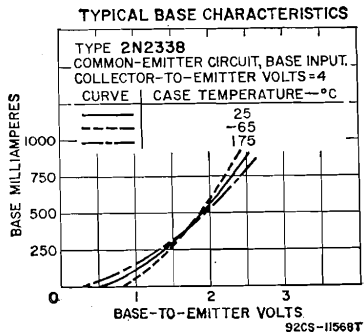



**POWER TRANSISTOR**

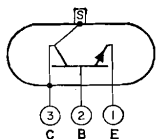

**2N2339**

Silicon n-p-n type used in a wide variety of switching and amplifier applications in industrial equipment. It is used in power-switching, dc-to-dc converter, inverter, chopper, and relay-control circuits; in oscillator, voltage- and current-regulator circuits; and in dc and servo amplifiers' circuits. This type has an offset pedestal, stud-mounted arrangement which provides heat-sink contact. Outline 28, Outlines Section. For curves of typical collector characteristics and base characteristics, refer to type 2N2338.

**MAXIMUM RATINGS**

Collector-to-Base Voltage (with emitter open) .....	60 max	volts
Collector-to-Emitter Voltage:		
With emitter-to-base volts = 1.5 .....	60 max	volts
With base open .....	40 max	volts
Emitter-to-Base Voltage (with collector open) .....	6 max	volts
Collector Current .....	2.5 max	amperes
Base Current .....	1 max	ampere
Transistor Dissipation:		
At case temperatures up to 25°C .....	40 max	watts
At case temperatures above 25°C .....	See curve	page 80
Temperature Range:		
Operating (junction) and Storage .....	-65 to 200	°C
Lead Temperature (for 10 seconds maximum) .....	255 max	°C

**CHARACTERISTICS**

Collector-to-Emitter Voltage (with emitter-to-base volts = 1.5 and collector ma = 0.75) .....	60 min	volts
Collector-to-Emitter Sustaining Voltage (with base open and collector ma = 100) .....	40 min	volts
Base-to-Emitter Voltage (with collector-to-emitter volts = 4 and collector ampere = 0.3) .....	3 max	volts
Collector-to-Emitter Saturation Voltage:		
With collector amperes = 1.5 and base ampere = 0.3 .....	9 max	volts
With collector ampere = 0.3 and base ampere = 0.03 .....	1.5 max	volts
Collector-Cutoff Current:		
With collector-to-emitter volts = 30 and base current = 0 .....	3 max	ma
With collector-to-emitter volts = 60 and base-to-emitter volts = -1.5 .....	0.75 max	ma
With collector-to-emitter volts = 30, base-to-emitter volts = -1.5, and case temperature = 200°C .....	20 max	ma
With collector-to-base volts = 30, emitter current = 0, and case temperature =		
25°C .....	0.1 max	ma
150°C .....	1.5 max	ma
Emitter-Cutoff Current (with emitter-to-base volts = 6 and collector current = 0) .....	0.05 max	ma
Thermal Time Constant .....	10	msec
Thermal Resistance:		
Junction-to-case .....	7 max	°C/watt
Junction-to-ambient .....	100 max	°C/watt

**In Common-Base Circuit**

Collector-to-Base Capacitance (with collector-to-base volts = 40, emitter current = 0, and frequency = 0.1 Mc) .....	300 max	pf
Small-Signal Forward-Current-Transfer-Ratio Cutoff Frequency (with collector-to-base volts = 28 and collector ma = 5) ....	1	Mc

**In Common-Emitter Circuit**

DC Forward Current-Transfer Ratio:		
With collector-to-emitter volts = 4 and collector ampere = 0.3 .....	20 to 80	
With collector-to-emitter volts = 4 and collector ampere = 1.5 .....	6 min	
Small-Signal Forward Current-Transfer Ratio:		
With collector-to-emitter volts = 4, collector ampere = 0.1 and frequency = 1 kilocycle .....	12 to 84	
With collector-to-emitter volts = 28, collector ampere = 0.02, and frequency = 0.1 Mc .....	7 min	
Collector-to-Emitter Saturation Resistance (with collector ampere = 0.3 and base ampere = 0.03) .....	5 max	ohms

TYPICAL OPERATION IN POWER-SWITCHING CIRCUIT BELOW

DC Collector Supply Voltage ( $V_{CC}$ )	12	volts
DC Base Supply Voltage ( $V_{BB}$ )	-8.5	volts
Generator Resistance	50	ohms
On DC Collector Current ( $I_C$ )	750	ma
Turn-On DC Base Current ( $I_{B1}$ )	65	ma
Turn-Off DC Base Current ( $I_{B2}$ )	-35	ma
Switching Time:		
Delay time ( $t_d$ )	0.2	$\mu$ sec
Rise time ( $t_r$ )	1	$\mu$ sec
Storage time ( $t_s$ )	0.8	$\mu$ sec
Fall time ( $t_f$ )	1.1	$\mu$ sec

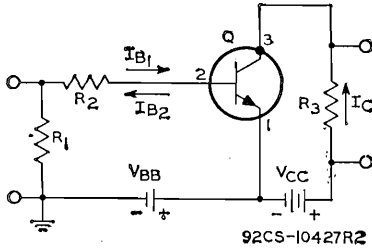

- $V_{BB}$  = 8.5 volts
- $V_{CC}$  = 12 volts
- $R_1$  = 50 ohms, 1 watt
- $R_2$  = 220 ohms, 1 watt
- $R_3$  = 15.9 ohms, 2 watts

POWER TRANSISTOR

2N2405

Silicon n-p-n type used in a wide variety of small-signal and medium-power switching applications in industrial and military equipment. It features high collector-to-emitter sustaining voltage, low leakage characteristics, high switching speeds, and a high dc forward current-transfer ratio.

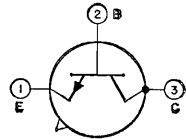

JEDEC No. TO-5 package; outline 6, Outlines Section. For curve of typical transfer characteristics, refer to type 2N1893.

MAXIMUM RATINGS

Collector-to-Base Voltage (with base-to-emitter reverse bias = 1.5 volts)	120 max	volts
Collector-to-Base Voltage (with emitter open)	120 max	volts
Collector-to-Emitter Voltage:		
With external base-to-emitter resistance = 10 ohms or less	140 max	volts
With external base-to-emitter resistance = 500 ohms	120 max	volts
Collector-to-Emitter Voltage (with base open)	90 max	volts
Emitter-to-Base Voltage (with collector open)	7 max	volts
Collector Current	1 max	ampere
Transistor Dissipation:		
At case temperatures up to 25°C	5 max	watts
At ambient temperatures up to 25°C	1 max	watt
At case or ambient temperatures above 25°C	See curve	page 80
Temperature Range:		
Operating (junction) and Storage	-65 to 200	°C
Lead Temperature (for 10 seconds maximum)	255 max	°C

CHARACTERISTICS

Collector-to-Base Breakdown Voltage (with collector ma = 0.1 and emitter current = 0)	120 min	volts
Emitter-to-Base Breakdown Voltage (with emitter ma = 0.1 and collector current = 0)	7 min	volts
Collector-to-Emitter Saturation Voltage:		
With base ma = 15 and collector ma = 150	0.5 max	volt
With base ma = 5 and collector ma = 50	0.2 max	volt
Base-to-Emitter Saturation Voltage:		
With base ma = 15 and collector ma = 150	1.1 max	volts
With base ma = 5 and collector ma = 50	0.9 max	volt

Collector-to-Emitter Sustaining Voltage:		
With base current = 0 and pulsed collector ma = 100*	90 min	volts
With base current = 0 and pulsed collector ma = 30*	90 min	volts
With external base-to-emitter resistance = 10 ohms and pulsed collector ma = 100*	140 min	volts
With external base-to-emitter resistance = 500 ohms and pulsed collector ma = 100*	120 min	volts
Collector-Cutoff Current:		
With case temperature = 25°C, collector-to-base volts = 90, and emitter current = 0	0.01 max	μa
With case temperature = 150°C, collector-to-base volts = 90, and emitter current = 0	10 max	μa
Emitter-Cutoff Current (with emitter-to-base volts = 5 and collector current = 0)	0.01 max	μa
Thermal Resistance:		
Junction-to-case	35 max	°C/watt
Junction-to-ambient	175 max	°C/watt

\* Pulse duration = 300 μsec, duty factor = 0.018

**In Common-Base Circuit**

Input Resistance at 1 kilocycle:		
With collector-to-base volts = 5 and collector ma = 1	24 to 34	ohms
With collector-to-base volts = 10 and collector ma = 5	4 to 8	ohms
Emitter-to-Base Capacitance (with emitter-to-base volts = 0.5 and collector current = 0)	80 max	pf
Collector-to-Base Capacitance (with collector-to-base volts = 10 and emitter current = 0)	15 max	pf
Output Conductance at 1 kilocycle:		
With collector-to-base volts = 5 and collector ma = 1	0.5 max	μmho
With collector-to-base volts = 10 and collector ma = 5	0.5 max	μmho
Small-Signal Open-Circuit Reverse Voltage-Transfer Ratio at 1 kilocycle:		
With collector-to-base volts = 5 and collector ma = 1	3 x 10 <sup>-4</sup>	
With collector-to-base volts = 10 and collector ma = 5	3 x 10 <sup>-4</sup>	

**In Common-Emitter Circuit**

DC Forward Current-Transfer Ratio:		
With collector-to-emitter volts = 10 and pulsed collector ma = 500*	25 min	
With collector-to-emitter volts = 10 and pulsed collector ma = 150*	60 to 200	
With collector-to-emitter volts = 10 and collector ma = 10	35 min	
With collector-to-emitter volts = 10, collector ma = 10, and case temperature = -55°C	20 min	
Small-Signal Forward Current-Transfer Ratio:		
With collector-to-emitter volts = 5, collector ma = 5, and frequency = 1 kilocycle	50 to 275	
With collector-to-emitter volts = 10, collector ma = 50, and frequency = 20 Mc	6 min	
Noise Figure (with collector-to-emitter volts = 10, collector ma = 0.3 generator resistance = 500 ohms, circuit bandwidth = 15 kilocycles, and signal frequency = 1 kilocycle)	6 max	db

\* Pulse duration = 300 μsec, duty factor = 0.018

**TYPICAL COLLECTOR CHARACTERISTICS**

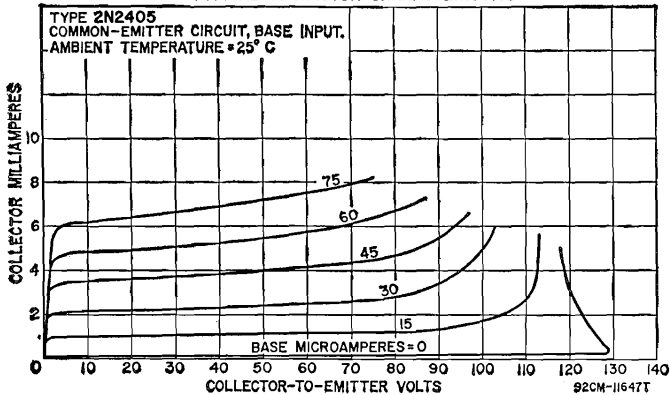

**TRANSISTOR**

**2N2475**

Silicon n-p-n type used in ultra-high-speed logic-circuit applications in data-processing equipment. Package is similar to JEDEC No. TO-18; outline 27, Outlines Section.

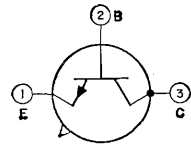

**MAXIMUM RATINGS**

Collector-to-Base Voltage (with emitter open) .....	15 max	volt
Collector-to-Emitter Voltage (with base open) .....	6 max	volt
Emitter-to-Base Voltage (with collector open) .....	4 max	volt
Transistor Dissipation:		
At case temperatures up to 100°C .....	500*max	mw
At ambient temperatures up to 25°C .....	300 max	mw
At ambient temperatures above 25°C .....	See curve	page 80
Temperature Range:		
Storage .....	-65 to 300	°C
Operating (junction) .....	-65 to 200	°C
Lead Temperature (for 10 seconds maximum) .....	300 max	°C

\* This rating must be reduced by 5 mw per °C for case temperature above 100°C.

**CHARACTERISTICS**

Base-to-Emitter Saturation Voltage (with collector ma = 20 and base ma = 0.66) .....	0.8 to 1.0	volt
Collector-to-Emitter Saturation Voltage (with collector ma = 20 and base ma = 0.66) .....	0.4 max	volt
Collector-Cutoff Current (with collector-to-base volts = 5 and emitter current = 0) .....	0.05 max	µa

*In Common-Base Circuit*

Output Capacitance (with collector-to-base volts = 5, emitter current = 0, and frequency = 140 kilocycles) .....	3 max	pf
Input Capacitance (with emitter-to-base volts = 0.5, collector current = 0, and frequency = 140 kilocycles) .....	2.5 max	pf

*In Common-Emitter Circuit*

Small-Signal Forward Current-Transfer Ratio (with collector-to-emitter volts = 2, collector ma = 20, and frequency = 100 Mc) .....	6 min
DC Forward Current-Transfer Ratio:	
With collector-to-emitter volts = 0.3 and collector ma = 1 ..	20 min
With collector-to-emitter volts = 0.5 and collector ma = 50 ..	20 min
With collector-to-emitter volts = 0.4 and collector ma = 20 ..	30 to 150

**TRANSISTOR**

**2N2476**

Silicon n-p-n type used in core-driving and line-driving applications requiring exceptionally fast switching speeds at high currents. JEDEC No. TO-5 package; outline 6, Outlines Section. This type is identical

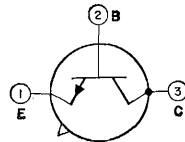

with type 2N2477 except for the following items:

**CHARACTERISTICS**

Collector-to-Emitter Saturation Voltage:		
With collector ma = 150 and base ma = 7.5 .....	0.4 max	volt
With collector ma = 500 and base ma = 50 .....	0.75 max	volt
Base-to-Emitter Voltage (with collector ma = 150 and base ma = 7.5) .....	1 max	volt

*In Common-Emitter Circuit*

DC Forward Current-Transfer Ratio (with collector-to-emitter volts = 0.4 and collector ma = 150) .....	20 min
--	--------

TRANSISTOR

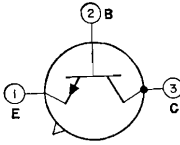

Silicon n-p-n type used in core-driving and line-driving applications requiring exceptionally fast switching speeds at high currents. JEDEC No. TO-5 package; outline 6, Outlines Section.

2N2477

MAXIMUM RATINGS

Table with 3 columns: Parameter, Value, and Unit. Includes Collector-to-Base Voltage (60 max volts), Transistor Dissipation (2 max watts), and Temperature Range (-65 to 200 °C).

CHARACTERISTICS

Table with 3 columns: Parameter, Value, and Unit. Includes Collector-to-Emitter Saturation Voltage (0.4 max volt) and Collector-Cutoff Current (0.2 max μa).

In Common-Base Circuit

Table with 3 columns: Parameter, Value, and Unit. Includes Output Capacitance (10 max pf).

In Common-Emitter Circuit

Table with 3 columns: Parameter, Value, and Unit. Includes DC Forward Current-Transfer Ratio (40 min) and Small-Signal Forward Current-Transfer Ratio (2.5 min).

TRANSISTOR

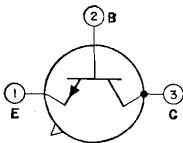

Germanium n-p-n type used for low-power radio-frequency amplifier applications in the vhf range in industrial and military equipment. JEDEC No. TO-18 package; outline 12, Outlines Section.

2N2482

MAXIMUM RATINGS

Table with 3 columns: Parameter, Value, and Unit. Includes Collector-to-Base Voltage (20 max volts), Transistor Dissipation (100 max ma), and Temperature Range (-65 to 100 °C).

CHARACTERISTICS

Table with 3 columns: Parameter, Value, and Unit. Includes Collector-to-Base Breakdown Voltage (20 min volts) and Collector-Cutoff Current (5 max μa).

**In Common-Base Circuit**

Output Capacitance (with collector-to-base volts = 6, emitter current = 0, and frequency = 140 kilocycles) .....	4.5 max	pf
Collector-to-Base Time Constant (with collector-to-base volts = 6, collector ma = 2, and frequency = 31.9 Mc) .....	0.3 max	$\mu$ sec

**In Common-Emitter Circuit**

DC Forward Current-Transfer Ratio (with collector-to-emitter volts = 6 and collector ma = 2) .....	25 to 200	
Small-Signal Forward Current-Transfer Ratio: With collector-to-emitter volts = 6, collector ma = 2, and frequency = 1 kilocycle .....	15 to 175	
With collector-to-emitter volts = 10, collector ma = 10, and frequency = 100 Mc .....	10	
With collector-to-emitter volts = 1.7, collector ma = 85, and frequency = 100 Mc .....	3 min	
Base Spreading Resistance (with collector-to-emitter volts = 6, collector ma = 10, and frequency = 250 Mc) .....	30	ohms
Noise Figure: With collector-to-emitter volts = 6, collector ma = 2, and frequency = 30 Mc .....	5	db
With collector-to-emitter volts = 6, collector ma = 2, and frequency = 100 Mc .....	6	db
Small-Signal Power Gain: With collector-to-emitter volts = 6, collector ma = 2, and frequency = 30 Mc .....	25	db
With collector-to-emitter volts = 6, collector ma = 2, and frequency = 100 Mc .....	12	db
With collector-to-emitter volts = 12, collector ma = 10, and frequency = 200 Mc .....	8	db
Power Output as Class A Amplifier (with collector-to-emitter volts = 12, collector ma = 30, signal input = 6.5 mw, and frequency = 70 Mc) .....	150	mw

**TRANSISTOR****2N2613**

Germanium p-n-p type used in a wide variety of small-signal and low-power applications in high-quality af-amplifier equipment. It is a low-noise high-gain type intended primarily for use in the input

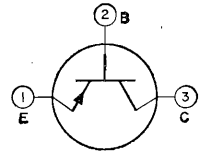

and low-level stages of equipment having stringent performance requirements at low idling-current levels (0.3 to 0.7 milliampere). It can also be used in the input stages of phonograph amplifiers using either ceramic or magnetic pickups, tape recorders and players, microphone amplifiers, and other similar applications. It features a high small-signal forward current-transfer ratio, excellent linearity over the entire range of collector current, high cutoff frequency, low saturation currents, and uniform gain characteristics over the entire audio-frequency spectrum. JEDEC No. TO-1 package; outline 4, Outlines Section.

**MAXIMUM RATINGS**

Collector-to-Base Voltage .....	-30 max	volts
Collector-to-Emitter Voltage (with external base-to-emitter resistance = 10000 ohms) .....	-25 max	volts
Emitter-to-Base Voltage .....	-25 max	volts
Collector Current .....	-50 max	ma
Emitter Current .....	50 max	ma
Transistor Dissipation: At ambient temperatures up to 55°C .....	120 max	mw
At ambient temperatures above 55°C .....	Derate 2.6	mw/°C
Temperature Range: Operating (junction) and Storage .....	-65 to 100	°C
Lead Temperature (for 10 seconds maximum) .....	255 max	°C

**CHARACTERISTICS**

Collector-to-Base Breakdown Voltage (with emitter-to-base volts = -2 and collector ma = -0.05) .....	-30 min	volts
---	---------	-------

Collector-to-Emitter Breakdown Voltage (with collector ma = -1 and external base-to-emitter resistance = 10000 ohms) ..	-25 min	volts
Emitter-to-Base Breakdown Voltage (with emitter ma = -0.05 and collector current = 0) ..	-25 min	volts
Collector-Cutoff Current (with collector-to-base volts = -20 and emitter current = 0) ..	-5 max	$\mu$ a
Emitter-Cutoff Current (with emitter-to-base volts = -20 and collector current = 0) ..	-7.5 max	$\mu$ a
Extrinsic Base-Lead Resistance (measured at 20 Mc with collector-to-emitter volts = -4.5 and collector ma = -0.5) ..	300	ohms

**In Common-Emitter Circuit**

Small-Signal Forward Current-Transfer Ratio (with collector-to-emitter volts = -4, collector ma = -0.5, and frequency = 1 kilocycle) ..	120 min	
Small-Signal Forward-Current Transfer-Ratio Cutoff Frequency (with collector-to-emitter volts = -4.5 and collector ma = -0.5) ..	10 typ	Mc
Noise Figure (with collector-to-emitter volts = -4.5, collector ma = -0.5, generator resistance = 1000 ohms, circuit bandwidth = 1.1 kilocycle, and signal frequency = 1 kilocycle) ..	4 max	db
Collector-to-Base Feedback Capacitance (with collector-to-emitter volts = -4.5 and collector ma = -0.5) ..	10	pf
Equivalent RMS Noise Input Current for the 20- to 20000-cps frequency range (with collector-to-emitter volts = -4.5, collector ma = -0.5, and external base-to-emitter resistance = 50000 ohms) ..	0.001* max	$\mu$ a

\*At ambient temperatures above 25°C, value may be higher.

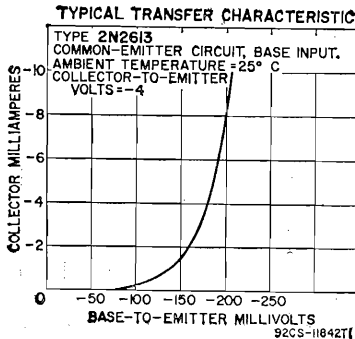
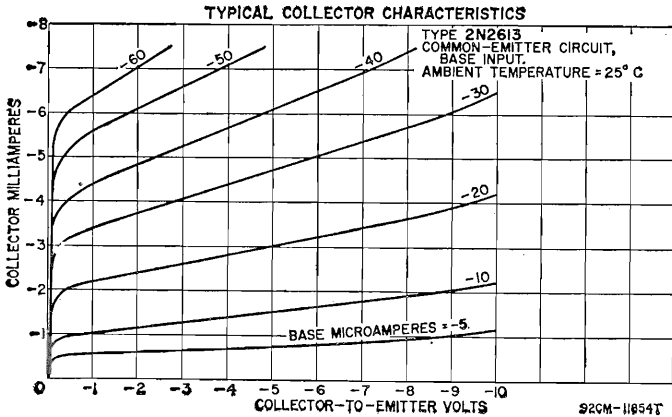

### TRANSISTOR

# 2N2614

Germanium p-n-p type used in a wide variety of small-signal and low-power applications in high-quality audio-frequency amplifier equipment. It is intended primarily for use in low-to-medium-level

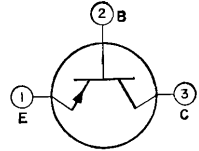

audio-amplifier and driver stages. It features a high small-signal forward current-transfer ratio, excellent linearity over the entire range of collector current, high cutoff frequency, low saturation currents, and uniform gain characteristics over the entire audio-frequency spectrum. JEDEC No. TO-1 package; outline 4, Outlines Section.

### MAXIMUM RATINGS

Collector-to-Base Voltage .....	-40 max	volts
Collector-to-Emitter Voltage (with external base-to-emitter resistance = 10000 ohms) .....	-35 max	volts
Emitter-to-Base Voltage .....	-25 max	volts
Collector Current .....	-50 max	ma
Emitter Current .....	50 max	ma
Transistor Dissipation:		
At ambient temperatures up to 55°C .....	120 max	mw
At ambient temperatures above 55°C .....	Derate 2.6	mw/°C
At case temperatures up to 55°C with infinite heat sink .....	300 max	mw
At case temperatures above 55°C with infinite heat sink .....	Derate 6.67	mw/°C
At case temperatures up to 55°C with typical heat sink .....	225 max	mw
At case temperatures above 55°C with typical heat sink .....	Derate 5	mw/°C
Temperature Range:		
Operating (junction) and Storage .....	-65 to 100	°C
Lead Temperature (for 10 seconds maximum) .....	255 max	°C

### CHARACTERISTICS

Collector-to-Base Breakdown Voltage (with emitter-to-base volts = -2 and collector ma = -0.05) .....	-40 min	volts
Collector-to-Emitter Breakdown Voltage (with collector ma = -1 and external base-to-emitter resistance = 10000 ohms) ..	-35 min	volts
Emitter-to-Base Breakdown Voltage (with emitter ma = -0.05 and collector current = 0) .....	-25 min	volts
Collector-Cutoff Current (with collector-to-base volts = -20 and emitter current = 0) .....	-5 max	µa
Emitter-Cutoff Current (with emitter-to-base volts = -20 and collector current = 0) .....	-7.5 max	µa
Extrinsic Base-Lead Resistance (measured at 20 Mc with collector-to-emitter volts = -6 and collector ma = -1) .....	300	ohms

#### In Common-Emitter Circuit

Small-Signal Forward Current-Transfer Ratio (with collector-to-emitter volts = -6, collector ma = -1 and frequency = 1 kilocycle) .....	100 min	
Small-Signal Forward-Current Transfer-Ratio Cutoff Frequency (with collector-to-emitter volts = -6 and collector ma = -1) .....	10	Mc
Collector-to-Base Feedback Capacitance (with collector-to-emitter volts = -6 and collector ma = -1) .....	9	pf

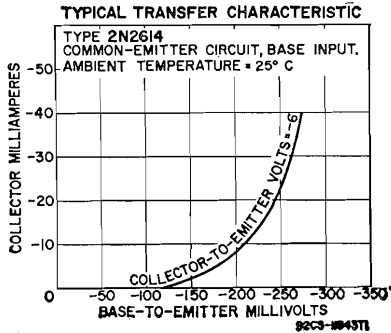



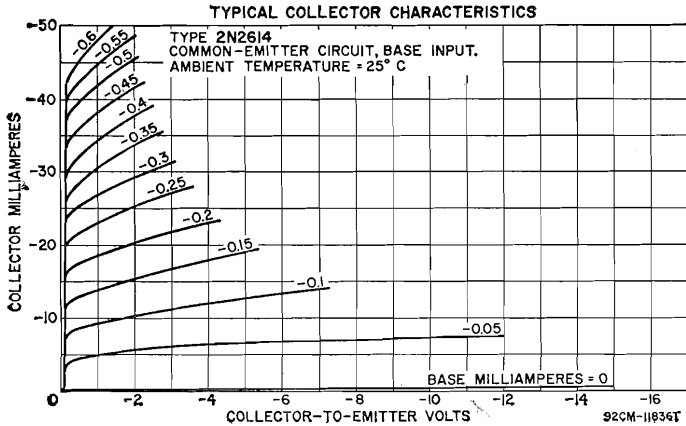

**POWER TRANSISTOR**

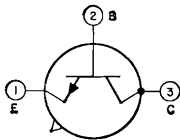

Silicon n-p-n type used in a wide variety of large-signal high-power vhf applications in military and industrial communications equipment. It is intended primarily for use in AM, FM, and CW circuits at fre-

**2N2631**

quencies up to 150 megacycles. It features high power output and high voltage ratings. This type is 100-per-cent tested to assure freedom from second breakdown in class A operation at maximum ratings. JEDEC No. TO-39 package; outline 32, Outlines Section. This type is identical with type 2N2876 except for the following items:

**MAXIMUM RATINGS**

Collector Current .....	1.5 max amperes
Transistor Dissipation:	
At case temperatures up to 25°C .....	8.75 max watts
At case temperatures above 25°C .....	See curve page 80

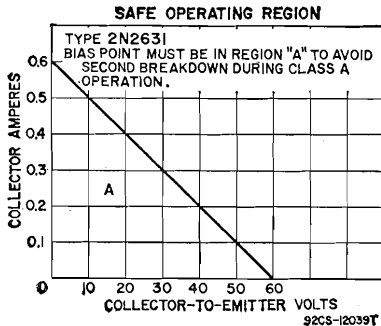

**CHARACTERISTICS**

Collector-to-Emitter Saturation Voltage (with base ma = 300 and collector amperes = 1.5) ..... 1 max volt

*In Common-Emitter Circuit*

Unneutralized RF Power Output (with load and generator impedance = 50 ohms):  
 With collector-to-emitter volts = 28, collector ma = 375, and frequency = 50 Mc ..... 7.5\* min watts  
 With collector-to-emitter volts = 28, collector ma = 275, and frequency = 150 Mc ..... 3\* min watts

\* Input power = 1 watt.

**POWER TRANSISTOR**

**2N2708**

Silicon n-p-n type used in a wide variety of vhf and uhf applications. It is intended primarily for use in amplifier, mixer, and oscillator applications in the frequency range from 200 to 500 megacycles. It uses

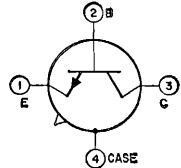

a four-lead package which has the same dimensions as the TO-18 package. Outline 31, Outlines Section.

**MAXIMUM RATINGS**

Collector-to-Base Voltage ..... 35 max volts  
 Collector-to-Emitter Voltage ..... 20 max volts  
 Emitter-to-Base Voltage ..... 3 max volts  
 Collector Current ..... Limited by power dissipation  
 Transistor Dissipation:  
 At ambient temperatures up to 25°C ..... 200 max mw  
 At ambient temperatures above 25°C ..... See curve page 80  
 Temperature Range:  
 Operating (junction) and Storage ..... -65 to 200 °C  
 Lead Temperature (for 10 seconds maximum) ..... 230 max °C

**CHARACTERISTICS**

Collector-to-Base Breakdown Voltage (with collector  $\mu$ a = 1 and emitter current = 0) ..... 35 min volts  
 Collector-to-Emitter Breakdown Voltage (with pulsed collector ma = 3\* and base current = 0) ..... 20 min volts  
 Emitter-to-Base Breakdown Voltage (with emitter  $\mu$ a = 10 and collector current = 0) ..... 3 min volts  
 Collector-Cutoff Current:  
 With ambient temperature = 25°C, collector-to-base volts = 15, and emitter current = 0 ..... 0.01 max  $\mu$ a  
 With ambient temperature = 150°C, collector-to-base volts = 15, and emitter current = 0 ..... 1 max  $\mu$ a

*In Common-Base Circuit*

Emitter-to-Base Capacitance\*\* (with emitter-to-base volts = 0.5, collector current = 0, and frequency = 140 kilocycles) . . . 1.4 pf  
 Collector-to-Base Capacitance\*\* (with collector-to-base volts = 15, emitter current = 0, and frequency = 140 kilocycles) . . . 1.5 max pf  
 Collector-to-Base Time Constant\*\*\* (with collector-to-base volts = 15, collector ma = 2, and frequency = 31.9 Mc) ..... 15 to 33 psec

*In Common-Emitter Circuit*

DC Forward Current-Transfer Ratio (with collector-to-emitter volts = 2 and collector ma = 2) ..... 30 to 200  
 Small-Signal Forward Current-Transfer Ratio (with collector-to-emitter volts = 15, collector ma = 2, and frequency = 1 kilocycle) ..... 30 to 180  
 Noise Figure (with collector-to-emitter volts = 15, collector ma = 2, source resistance = 50 ohms, and frequency = 200 Mc) .. 8.5 max db  
 Transconductance (with collector-to-emitter volts = 15, collector ma = 2, and frequency = 200 Mc) ..... 25 mmho

Small-Signal Common Emitter Power Gain with collector-to-emitter volts = 15, collector ma = 2, and frequency = 200 Mc:

Neutralized .....	15 to 22	db
Unneutralized .....	12	db
Magnitude of Small-Signal Forward Current-Transfer Ratio (with collector-to-emitter volts = 15, and collector ma = 2) ..	7 to 12	

- \* Pulse duration = 300  $\mu$ sec or less; duty factor = 0.01 or less.
- \*\* With lead No. 4 (case) not connected.
- \*\*\* Lead No. 4 (case) grounded.

## POWER TRANSISTOR

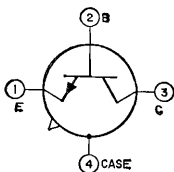

Silicon n-p-n type used in a wide variety of uhf applications in industrial and military equipment. It is used primarily in low-noise amplifier, oscillator, and converter circuits. When operated in the common-

# 2N2857

emitter configuration, it is useful up to 500 megacycles; in the common-base configuration, up to 1200 megacycles. This type features a high gain-bandwidth product, high converter gain, high power gain as a neutralized amplifier, high power output as a uhf oscillator, low noise figure, and a low collector-to-base time constant. It uses a four-lead package which has the same dimensions as the TO-18 package. (The fourth lead may be used to ground the case in applications requiring shielding of the device.) Outline 31, Outlines Section.

### MAXIMUM RATINGS

Collector-to-Base Voltage .....	30 max	volts
Collector-to-Emitter Voltage .....	15 max	volts
Emitter-to-Base Voltage .....	2.5 max	volts
Collector Current .....	20 max	ma
Transistor Dissipation:		
At ambient temperatures up to 25°C .....	200 max	mw
At ambient temperatures above 25°C .....	See curve	page 80
At case temperatures up to 25°C (with heat sink) .....	300 max	mw
At case temperatures above 25°C (with heat sink) .....	See curve	page 80
Temperature Range:		
Operating (junction) and Storage .....	-65 to 200	°C
Lead Temperature (for 10 seconds maximum) .....	230 max	°C

### CHARACTERISTICS

Collector-to-Base Breakdown Voltage (with collector ma = 0.001 and emitter current = 0) .....	30 min	volts
Collector-to-Emitter Breakdown Voltage (with collector ma = 3 and base current = 0) .....	15 min	volts
Emitter-to-Base Breakdown Voltage (with emitter ma = 0.01 and collector current = 0) .....	2.5 min	volts
Collector-Cutoff Current (with collector-to-base volts = 15 and emitter current = 0) .....	0.01 max	$\mu$ a

#### In Common-Base Circuit

Emitter-to-Base Capacitance* (with emitter-to-base volts = 0.5, collector current = 0, and frequency = 0.140 Mc) .....	1.4	pf
Collector-to-Base Capacitance** (with collector-to-base volts = 10, emitter current = 0, and frequency = 0.140 Mc) .....	1.8 max	pf
Collector-to-Base Time Constant* (with collector-to-base volts = 6, collector ma = 2, and frequency = 31.9 Mc) .....	4 to 15	psec
Power Output as oscillator (with collector-to-base volts = 10, emitter ma = 12, and frequency = 500 Mc) .....	30 min	mw

#### In Common-Emitter Circuit

DC Forward Current-Transfer Ratio (with collector-to-emitter volt = 1 and collector ma = 3) .....	30 to 150	
Small-Signal Forward Current-Transfer Ratio* (with collector-to-emitter volts = 6, collector ma = 2, frequency = 0.001 Mc) .....	50 to 220	
Noise Figure** (with collector-to-emitter volts = 6, collector ma = 1.5, frequency = 450 Mc, and source resistance = 50 ohms) .....	4.5 max	db

Small-Signal Common-Emitter Power Gain (with collector-to-emitter volts = 6, collector ma = 1.5, and frequency = 450 Mc) 12.5 to 19 db

- \* Fourth Lead (case) not connected.
- \*\* Lead No. 4 grounded.

**POWER TRANSISTOR**

**2N2869/  
2N301**

Germanium p-n-p type used in a wide variety of af power-amplifier and large-signal applications in commercial, industrial, and military equipment. It is used in class A and class B af-output-amplifier stages of

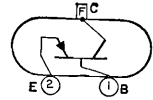

automobile radio receivers and mobile communications equipment. It provides excellent dc-to-dc and dc-to-ac power conversion. This type features high breakdown voltage, low saturation voltage, high large-signal beta, and a high dissipation capability. JEDEC No. TO-3 package; outline 5, Outlines Section.

**MAXIMUM RATINGS**

Collector-to-Base Voltage	-60 max	volts
Collector-to-Emitter Voltage	-50 max	volts
Emitter-to-Base Volts	-10 max	volts
Collector Current	-10 max	amperes
Emitter Current	10 max	amperes
Base Current	-3 max	amperes
Transistor Dissipation:		
At mounting-flange temperatures up to 55°C	30 max	watts
At mounting-flange temperatures above 55°C	Derate 0.66 watt/°C	
Temperature Range:		
Operating (junction) and Storage	-65 to 100	°C
Lead Temperature (for 10 seconds maximum)	255 max	°C

**CHARACTERISTICS**

Collector-to-Base Breakdown Voltage (with collector ma = -5 and emitter current = 0)	-60 min	volts
Collector-to-Emitter Breakdown Voltage (with collector ma = -600 and base current = 0)	-50 min	volts
Emitter-to-Base Breakdown Voltage (with emitter ma = -2 and collector current = 0)	-10 min	volts
Collector-to-Emitter Saturation Voltage (with collector amperes = -10 and base ampere = -1)	-0.75 max	volt
Base-to-Emitter Voltage (with collector-to-emitter volts = -2 and collector ampere = -1)	-0.5 max	volt
Collector-Cutoff Current (with collector-to-base volts = -30 and emitter current = 0)	-0.5 max	ma
Collector-Cutoff Saturation Current (with collector-to-base volts = -0.5 and emitter current = 0)	-0.1 max	ma

**In Common-Emitter Circuit**

DC Forward Current-Transfer Ratio (with collector-to-emitter volts = -2 and collector ampere = -1)	50 to 165
Gain-Bandwidth Product (with collector-to-emitter volts = -2 and collector ampere = -1)	450 Kc

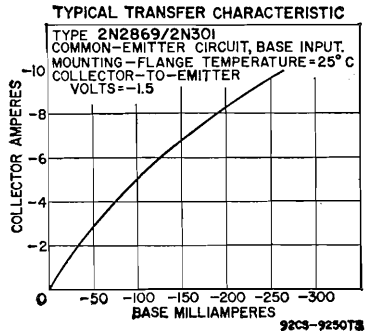
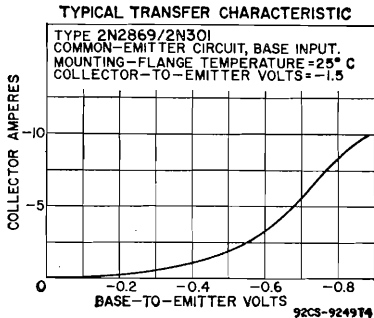

**TYPICAL OPERATION IN CLASS A<sub>1</sub> AF POWER AMPLIFIER CIRCUIT**

Mounting-flange temperature of 80°C

DC Supply Voltage	-14.4	volts
DC Collector-to-Emitter Voltage	-12.2	volts
DC Base-to-Emitter Voltage	-0.35	volt
Zero-Signal Collector Current	-0.9	ampere
Signal Frequency	400	cps
Signal-Source Impedance	10	ohms
Load Impedance	15	ohms
Power Gain	38	db
Maximum-Signal Power Output	5	watts
Circuit Efficiency (at power output of 5 watts)	45	per cent
Maximum Total Harmonic Distortion (at power output of watts)	5	per cent
Zero-Signal Collector Dissipation	11	watts

**TYPICAL OPERATION IN CLASS B PUSH-PULL AUDIO POWER-AMPLIFIER CIRCUIT**

Mounting-flange temperature of 80°C; values are for two transistors except as noted

DC Supply Voltage	-14.4	volts
Zero-Signal DC Base-to-Emitter Voltage	-0.13	volt
Zero-Signal DC Collector Current (per transistor)	-0.05	ampere
Peak Collector current (per transistor)	-2	amperes
Maximum-Signal DC Collector Current (per transistor)	-0.64	ampere
Signal Frequency	400	cps
Signal-Source Impedance per base	10	ohms
Load Impedance per collector	6	ohms
Power Gain	30	db
Maximum-Signal Power Output	12	watts
Maximum Total Harmonic Distortion (at power output of 12 watts)	5	per cent
Circuit Efficiency (at power output of 12 watts)	67	per cent
Collector Dissipation (per transistor at power output of 12 watts)	3	watts

**TYPICAL COLLECTOR CHARACTERISTICS**

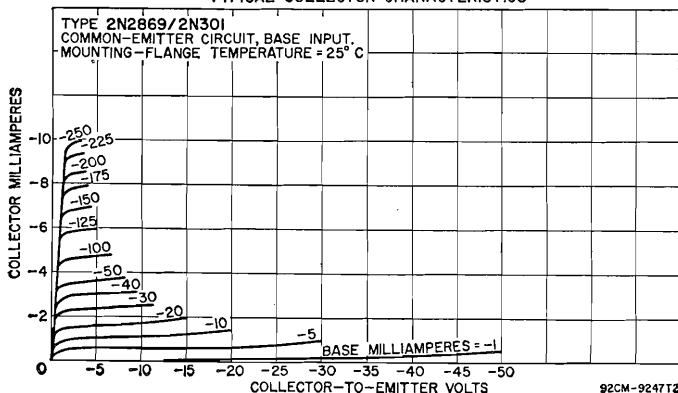

**POWER TRANSISTOR**

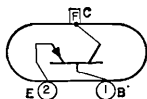

Germanium p-n-p type used in a wide variety of af power-amplifier and large-signal applications in commercial, industrial, and military equipment. It is used in class A and class B af-output-amplifier stages

**2N2870/  
2N301A**

of automobile radio receivers and mobile communications equipment. It provides excellent dc-to-dc and dc-to-ac power conversion. This type features high breakdown voltage, low saturation voltage, high large-signal beta, and a high dissipation capability. JEDEC No. TO-3 package; outline 5, Outlines Section. This type is identical with type 2N2869/2N301 except for the following items:

**MAXIMUM RATINGS**

Collector-to-Base Voltage .....	-80 max	volts
---------------------------------	---------	-------

**CHARACTERISTICS**

Collector-to-Base Breakdown Voltage (with collector $i_a = -5$ and emitter current = 0) .....	-80 min	volts
Collector-to-Emitter Saturation Voltage (with collector amperes = -10 and base ampere = -1) .....	-0.5 max	volt

**2N2873**

See list of Discontinued Transistors at end of Technical Data Section for abbreviated data.

**POWER TRANSISTOR****2N2876**

Silicon n-p-n type used in a wide variety of large-signal high-power vhf applications in military and industrial communications equipment. It is intended primarily for use in AM, FM, and CW circuits at fre-

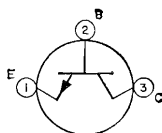

quencies up to 150 megacycles. It features high power output and high voltage ratings. This type is 100 per cent tested to assure freedom from second breakdown in class A operation at maximum ratings. It uses a special stud-mounted package which is electrically isolated from all electrodes and designed to provide excellent performance at high frequencies. Outline 35, Outlines Section.

**MAXIMUM RATINGS**

Collector-to-Base Voltage .....	80 max	volts
Collector-to-Emitter Voltage:		
With base open .....	60 max	volts
With base-to-emitter volts = 1.5 .....	80 max	volts
Emitter-to-Base Voltage .....	4 max	volts
Collector Current .....	2.5 max	amperes
Transistor Dissipation:		
At case temperatures up to 25°C .....	17.5 max	watts
At case temperatures above 25°C .....	See curve	page 80
Temperature Range:		
Operating (junction) and Storage .....	-65 to 200	°C
Lead Temperature (for 10 seconds maximum) .....	230 max	°C

**CHARACTERISTICS**

Collector-to-Base Breakdown Voltage (with collector $i_a = 0.5$ and emitter current = 0) .....	80 min	volts
Collector-to-Emitter Sustaining Breakdown Voltage (with pulsed collector $i_a = 500^*$ and base current = 0) .....	60 min	volts
Collector-to-Emitter Breakdown Voltage (with base-to-emitter volts = -1.5 and collector $i_a = 0.1$ ) .....	80 min	volts
Emitter-to-Base Breakdown Voltage (with emitter $i_e = 0.1$ and collector current = 0) .....	4 min	volts
Collector-to-Emitter Saturation Voltage (with base $i_b = 500$ and collector amperes = 2.5) .....	1 max	volt
Collector-Cutoff Current (with collector-to-base volts = 30 and emitter current = 0) .....	0.1 max	$\mu$ A
Collector-to-Case Capacitance .....	6 max	pf

**In Common-Base Circuit**

Collector-to-Base Capacitance (with collector-to-base volts = 30, emitter current = 0, and frequency = 140 kilocycles) ..	20 max	pf
---	--------	----

**In Common-Emitter Circuit**

Base Spreading Resistance (with collector-to-emitter volts = 28, collector $i_a = 250$ , and frequency = 400 Mc) .....	6	ohms
--	---	------

Gain-Bandwidth Product (with collector-to-emitter volts = 28 and emitter ma = 250)	200	Mc
Unneutralized RF Power Output (with load and generator impedance = 50 ohms):		
With collector-to-emitter volts = 28, collector ma = 500, and frequency = 50 Mc	10** min	watts
With collector-to-emitter volts = 28, collector ma = 275, and frequency = 150 Mc	3† min	watts

\* Pulse duration = 5  $\mu$ sec or less; duty factor = 0.01 or less.  
 \*\* Input power = 2 watts.  
 † Input power = 1 watt.

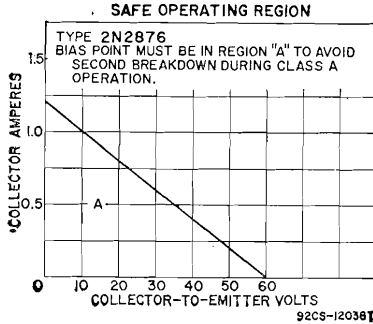

TRANSISTOR

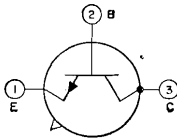

Silicon n-p-n type used in a wide variety of small-signal and low-to-medium power applications in military and industrial equipment. It features extremely low leakage characteristics, high pulse beta, high

2N2895

small-signal beta, very low capacitance, and large gain-bandwidth product. This type has an exceptionally low noise figure of 8 db maximum and offers five levels of beta control from 0.1 ma to 0.5 ampere. JEDEC No. TO-18 package; outline 12, Outlines Section.

MAXIMUM RATINGS

Collector-to-Base Voltage	120 max	volts
Collector-to-Emitter Voltage:		
With base open	65 max	volts
With base-to-emitter resistance = 10 ohms or less	80 max	volts
Emitter-to-Base Voltage	7 max	volts
Collector Current	1 max	ampere
Transistor Dissipation:		
At case temperatures up to 25°C	1.8 max	watts
At ambient temperatures up to 25°C	0.5 max	watt
At case and ambient temperatures above 25°C	See curve	page 80
Temperature Range:		
Operating (junction) and Storage	-65 to 200	°C
Lead Temperature (for 10 seconds maximum)	255 max	°C

CHARACTERISTICS

Collector-to-Base Breakdown Voltage (with collector ma = 0.1 and emitter current = 0)	120 min	volts
Emitter-to-Base Breakdown Voltage (with emitter ma = 0.1 and collector current = 0)	7 min	volts
Collector-to-Emitter Sustaining Voltage:		
With base open, pulsed collector ma = 100*, and base current = 0	65 min	volts
With emitter-to-base resistance = 10 ohms, and pulsed collector ma = 100*	30 min	volts
Collector-to-Emitter Saturation Voltage (with pulsed collector ma = 150* and base ma = 15)	0.6 max	volt
Base-to-Emitter Saturation Voltage (with pulsed collector ma = 150* and base ma = 15)	1.2 max	volts

Collector-Cutoff Current:			
With case temperature = 25°C, collector-to-base volts = 60,		0.002 max	μA
and emitter current = 0			
With case temperature = 150°C, collector-to-base volts = 60,		2 max	μA
and emitter current = 0			
Emitter-Cutoff Current (with emitter-to-base volts = 5		0.002 max	μA
and collector current = 0			
Thermal Resistance:			
Junction-to-case		97 max	°C/watt
Junction-to-ambient		350 max	°C/watt

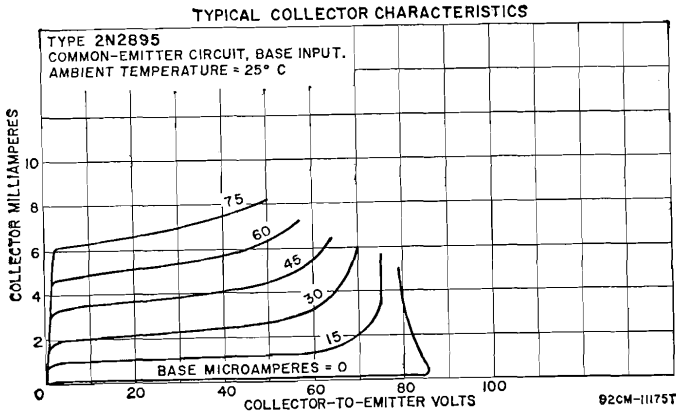
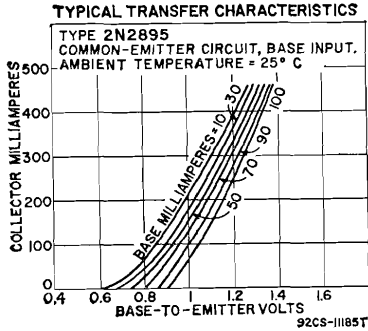

**In Common-Base Circuit**

Emitter-to-Base Capacitance (with emitter-to-base volt = 0.5, collector current = 0, and frequency = 140 kilocycles) .	80 max	pf
Collector-to-Base Capacitance (with collector-to-base volts = 10, emitter current = 0, and frequency = 140 kilocycles) ..	15 max	pf

**In Common-Emitter Circuit**

DC Forward Current-Transfer Ratio:		
With collector-to-emitter volts = 10 and pulsed collector ma = 150*	40 to 120	
With collector-to-emitter volts = 10 and pulsed collector ma = 500*	25 min	
With collector-to-emitter volts = 10 and collector ma = 0.1	20 min	
With collector-to-emitter volts = 10 and collector ma = 10	35 min	
With case temperature = -55°C, collector-to-emitter volts = 10, and collector ma = 10	20 min	
Small-Signal Forward Current-Transfer Ratio:		
With collector-to-emitter volts = 5, collector ma = 5, and frequency = 1 kilocycle	50 to 200	
With collector-to-emitter volts = 10, collector ma = 50, and frequency = 20 Mc	6 min	



Noise Figure (with collector-to-emitter volts = 10, collector ma = 0.3, generator resistance = 510 ohms, circuit bandwidth = 1 cps, and frequency = 1 kilocycle) ..... 8 max db

\* Pulse duration = 300  $\mu$ sec; duty factor = 0.018.

**TRANSISTOR**

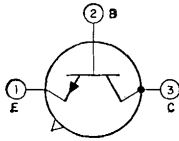

Silicon n-p-n type used in a wide variety of small-signal and low-to-medium power applications in military and industrial equipment. It features extremely low leakage characteristics, high pulse beta, high

**2N2896**

small-signal beta, very low capacitance, and large gain-bandwidth product. JEDEC No. TO-18 package; outline 12, Outlines Section. For curve of typical transfer characteristics, refer to 2N2895.

**MAXIMUM RATINGS**

Collector-to-Base Voltage .....	140 max	volts
Collector-to-Emitter Voltage:		
With base open .....	90 max	volts
With base-to-emitter resistance = 10 ohms or less .....	140 max	volts
Emitter-to-Base Voltage .....	7 max	volts
Collector Current .....	1 max	ampere
Transistor Dissipation:		
At case temperatures up to 25°C .....	1.8 max	watts
At ambient temperatures up to 25°C .....	0.5 max	watt
At case and ambient temperatures above 25°C .....	See curve	page 80
Temperature Range:		
Operating (junction) and Storage .....	-65 to 200	°C
Lead Temperature (for 10 seconds maximum) .....	255 max	°C

**CHARACTERISTICS**

Collector-to-Base Breakdown Voltage (with collector ma = 0.1 and emitter current = 0) .....	140 min	volts
Emitter-to-Base Breakdown Voltage (with emitter ma = 0.1 and collector current = 0) .....	7 min	volts
Collector-to-Emitter Sustaining Voltage:		
With base open, pulsed collector ma = 100*, and base current = 0 .....	90 min	volts
With emitter-to-base resistance = 10 ohms, and pulsed collector ma = 100* .....	140 min	volts
Collector-to-Emitter Saturation Voltage (with pulsed collector ma = 150* and base ma = 15) .....	0.6 max	volt
Base-to-Emitter Saturation Voltage (with pulsed collector ma = 150* and base ma = 15) .....	1.2 max	volts
Collector-Cutoff Current:		
With case temperature = 25°C, collector-to-base volts = 90, and emitter current = 0 .....	0.01 max	$\mu$ a
With case temperature = 150°C, collector-to-base volts = 90 and emitter current = 0 .....	10 max	$\mu$ a
Emitter-Cutoff Current (with emitter-to-base volts = 5 and collector current = 0) .....	0.01 max	$\mu$ a
Thermal Resistance:		
Junction-to-case .....	97 max	°C/watt
Junction-to-ambient .....	350 max	°C/watt

**In Common-Base Circuit**

Emitter-to-Base Capacitance (with emitter-to-base volt = 0.5, collector current = 0, and frequency = 140 kilocycles) .....	80 max	pf
Collector-to-Base Capacitance (with collector-to-base volts = 10, emitter current = 0, and frequency = 140 kilocycles) .....	15 max	pf

**In Common-Emitter Circuit**

DC Forward Current-Transfer Ratio:		
With collector-to-emitter volts = 10 and pulsed collector ma = 150* .....	60 to 200	
With collector-to-emitter volts = 10 and collector ma = 1 .....	35 min	
With case temperature = -55°C, collector-to-emitter volts = 10, and collector ma = 10 .....	20 min	
Small-Signal Forward Current-Transfer Ratio:		
With collector-to-emitter volts = 5, collector ma = 5, and frequency = 1 kilocycle .....	50 to 275	
With collector-to-emitter volts = 10, collector ma = 50, and frequency = 20 Mc .....	6 min	

\* Pulse duration = 300  $\mu$ sec; duty factor = 0.018.

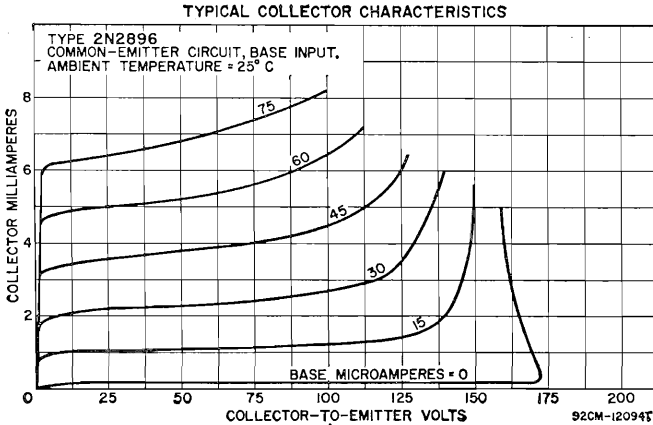

**TRANSISTOR**

**2N2897**

Silicon n-p-n type used in a wide variety of small-signal and low-to-medium power applications in military and industrial equipment. It features extremely low leakage characteristics, high pulse beta, high

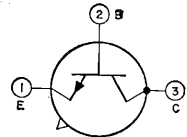

small-signal beta, very low capacitance, and large gain-bandwidth product. JEDEC No. TO-18 package; outline 12, Outlines Section.

**MAXIMUM RATINGS**

Collector-to-Base Voltage .....	60 max	volts
Collector-to-Emitter Voltage:		
With base open .....	45 max	volts
With base-to-emitter resistance = 10 ohms or less .....	60 max	volts
Emitter-to-Base Voltage .....	7 max	volts
Collector Current .....	1 max	ampere
Transistor Dissipation:		
At case temperatures up to 25°C .....	1.8 max	watts
At ambient temperatures up to 25°C .....	0.5 max	watt
At case and ambient temperatures above 25°C .....	See curve	page 80
Temperature Range:		
Operating (junction) and Storage .....	-65 to 200	°C
Lead Temperature (for 10 seconds maximum) .....	255 max	°C

**CHARACTERISTICS**

Collector-to-Base Breakdown Voltage (with collector ma = 0.1 and emitter current = 0) .....	60 min	volts
Emitter-to-Base Breakdown Voltage (with emitter ma = 0.1 and collector current = 0) .....	7 min	volts
Collector-to-Emitter Sustaining Voltage:		
With base open, pulsed collector ma = 100*, and base current = 0 .....	45 min	volts
With emitter-to-base resistance = 10 ohms and pulsed collector ma = 100* .....	60 min	volts
Collector-to-Emitter Saturation Voltage (with pulsed collector ma = 150* and base ma = 15) .....	1 max	volt
Base-to-Emitter Saturation Voltage (with pulsed collector ma = 150* and base ma = 15) .....	1.3 max	volts
Collector-Cutoff Current:		
With case temperature = 25°C, collector-to-base volts = 60, and emitter current = 0 .....	0.05 max	μa
With case temperature = 150°C, collector-to-base volts = 60, and emitter current = 0 .....	50 max	μa
Emitter-Cutoff Current (with emitter-to-base volts = 5 and collector current = 0) .....	0.05 max	μa
Thermal Resistance:		
Junction-to-case .....	97 max	°C/watt
Junction-to-ambient .....	350 max	°C/watt

**In Common-Base Circuit**

Emitter-to-Base Capacitance (with emitter-to-base volt = 0.5, collector current = 0, and frequency = 140 kilocycles) . . . . .	80 max	pf
Collector-to-Base Capacitance (with collector-to-base volts = 10, emitter current = 0, and frequency = 140 kilocycles) . . . . .	15 max	pf

**In Common-Emitter Circuit**

DC Forward Current-Transfer Ratio:

With collector-to-emitter volts = 10, and pulsed collector ma = 150* . . . . .	50 to 200
With collector-to-emitter volts = 10, and collector ma = 1 . . . . .	35 min

Small-Signal Forward Current-Transfer Ratio:

With collector-to-emitter volts = 5, collector ma = 5, and frequency = 1 kilocycle . . . . .	50 to 275
With collector-to-emitter volts = 10, collector ma = 50, and frequency = 20 Mc . . . . .	5 min

\* Pulse duration = 300  $\mu$ sec; duty factor = 0.018.

**TYPICAL TRANSFER CHARACTERISTICS**

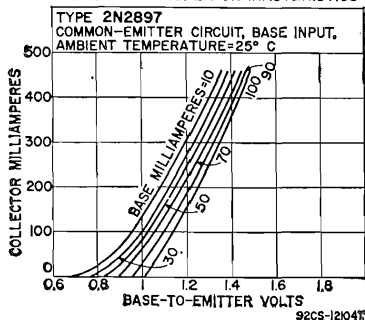

**TYPICAL COLLECTOR CHARACTERISTICS**

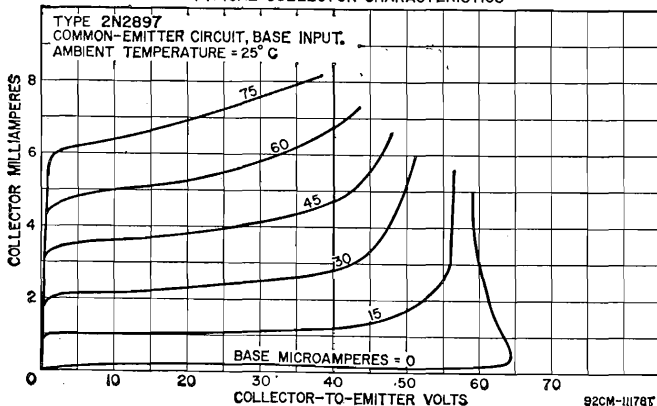

**TRANSISTOR**

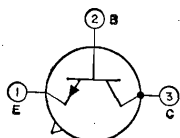

Silicon n-p-n type used in a wide variety of small-signal and low-to-medium power applications in military and industrial equipment. It features extremely low leakage characteristics, high pulse beta, high small-signal beta, very low capacitance, and large gain-bandwidth product.

**2N2898**

This type has an exceptionally low noise figure of 8 db maximum and offers five levels of beta control from 0.1 ma to 0.5 ampere. JEDEC No. TO-46 package; outline 18, Outlines Section. This type is electrically identical with type 2N2895.

**TRANSISTOR**

**2N2899**

Silicon n-p-n type used in a wide variety of small-signal and low-to-medium power applications in military and industrial equipment. It features extremely low leakage characteristics, high pulse beta, high small-signal beta, very low capacitance, and large gain-bandwidth product. JEDEC No. TO-46 package; outline 18, Outlines Section. This type is electrically identical with type 2N2896.

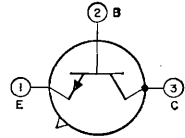

**TRANSISTOR**

**2N2900**

Silicon n-p-n type used in a wide variety of small-signal and low-to-medium power applications in military and industrial equipment. It features extremely low leakage characteristics, high pulse beta, high small-signal beta, very low capacitance, and large gain-bandwidth product. JEDEC No. TO-46 package; outline 18, Outlines Section. This type is electrically identical with type 2N2897.

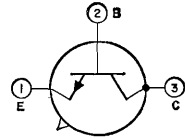

**TRANSISTOR**

**2N2938**

Silicon n-p-n type used in switching applications in military and commercial data-processing equipment. This type features high beta and high switching speed at high values of collector current, as well as low base and collector cutoff currents, low saturation voltages at high values of collector current, and exceptional stability of characteristics. JEDEC No. TO-52 package; outline 20, Outlines Section.

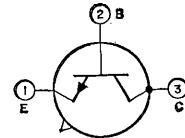

**MAXIMUM RATINGS**

Collector-to-Base Voltage .....	25 max	volts
Collector-to-Emitter Voltage .....	13 max	volts
Emitter-to-Base Voltage .....	5 max	volts
Collector Current .....	500 max	ma
Transistor Dissipation:		
At case temperatures up to 25°C .....	1 max	watt
At ambient temperatures up to 25°C .....	0.3 max	watt
At case or ambient temperatures above 25°C .....	See curve page 80	
Temperature Range:		
Operating .....	-65 to 175	°C
Storage .....	-65 to 200	°C
Lead Temperature (for 10 seconds maximum) .....	300 max	°C

**CHARACTERISTICS**

Collector-to-Emitter Saturation Voltage (with collector ma = 50 and base ma = 1.6) .....	0.4 max	volt
Base-to-Emitter Saturation Voltage (with collector ma = 50 and base ma = 1.6) .....	0.8 to 0.95	volt

Collector-Cutoff Current:

With ambient temperature = 25°C, collector-to-emitter volts = 20, and emitter-to-base volts = 0 .....	25 max	μa
With ambient temperature = 150°C, collector-to-emitter volts = 20, and emitter-to-base volts = 0 .....	25 max	μa

In Common-Base Circuit

Emitter-to-Base Capacitance (with emitter-to-base volts = 1 and base current = 0) .....	5 max	pf
Collector-to-Base Capacitance (with collector-to-base volts = 5 and emitter current = 0) .....	4 max	pf

In Common-Emitter Circuit

DC Forward Current-Transfer Ratio:		
With collector-to-emitter volt = 0.35 and collector ma = 10 ..	125	
With collector-to-emitter volt = 0.4 and pulsed collector ma = 50*	105	
With collector-to-emitter volt = 1 and pulsed collector ma = 200*	60	
With collector-to-emitter volt = 0.4, pulsed collector ma = 50*, and ambient temperature = -55°C .....	65	
Small-Signal Forward Current-Transfer Ratio (with collector-to-emitter volts = 10, collector ma = 10, and frequency = 100 Mc) .....	6.9	

\* Pulse duration = 50 μsec; duty factor = 0.02 or less.

TRANSISTOR

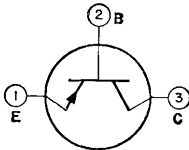

Germanium p-n-p type used in audio-frequency driver-amplifier applications in consumer and industrial equipment. This type features exceptionally high gain under typical operating conditions for driver

**2N2953**

circuits, excellent linearity of small-signal beta and dc beta over its entire collector-current range, and uniform gain characteristics over the audio-frequency range. All leads are insulated from the case to permit use of the equipment chassis as a heat sink. JEDEC No. TO-1 package; outline 4, Outlines Section.

MAXIMUM RATINGS

Collector-to-Base Voltage .....	-30 max	volts
Collector-to-Emitter Voltage (with base-to-emitter resistance = 10000 ohms or less) .....	-25 max	volts
Emitter-to-Base Voltage .....	-25 max	volts
Collector Current .....	-150 max	ma
Emitter Current .....	150 max	ma
Transistor Dissipation:		
At ambient temperatures up to 55°C .....	120 max	mw
At ambient temperatures above 55°C .....	Derate 2.6	mw/°C
At case temperatures up to 55°C with infinite heat sink .....	300 max	mw
At case temperatures above 55°C with infinite heat sink .....	Derate 6.67	mw/°C
At case temperatures up to 55°C with practical heat sink* .....	225 max	mw
At case temperatures above 55°C with practical heat sink* .....	Derate 5	mw/°C
Temperature Range:		
Operating (junction) and Storage .....	-65 to 100	°C
Lead Temperature (for 10 seconds maximum) .....	255 max	°C

CHARACTERISTICS

Collector-to-Base Breakdown Voltage (with emitter-to-base volts = -2 and collector ma = -0.05) .....	-30 min	volts
Collector-to-Emitter Breakdown Voltage (with base-to-emitter resistance = 10000 ohms and collector ma = -1) .....	-25 min	volts
Emitter-to-Base Breakdown Voltage (with emitter ma = -0.05) .....	-25 min	volts
Collector-Cutoff Current (with collector-to-base volts = -20 and emitter current = 0) .....	-5 max	μa
Emitter-Cutoff Current (with emitter-to-base volts = -20 and collector current = 0) .....	-7.5 max	μa

**In Common-Emitter Circuit**

Small-Signal Forward Current-Transfer Ratio (with collector-to-emitter volts = -10, collector ma = -10 and frequency = 1 kilocycle) .....	200	min
Small-Signal Forward Current-Transfer Ratio Cutoff Frequency (with collector-to-emitter volts = -12 and collector ma = -1) .....	10	Mc
Extrinsic Base-Lead Resistance (with collector-to-emitter volts = 10, collector ma = -10, and frequency = 20 Mc) .....	300	ohms
Collector-to-Base Feedback Capacitance (with collector-to-emitter volts = -12 and collector ma = -1) .....	6.5	pf

\* Thermal resistance of heat sink is less than 50°C/watt.

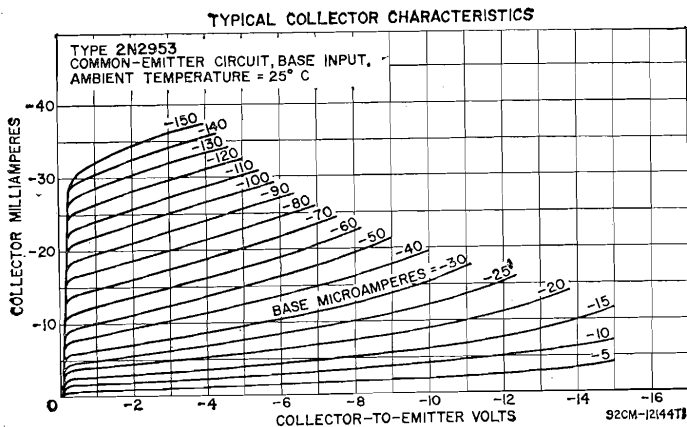
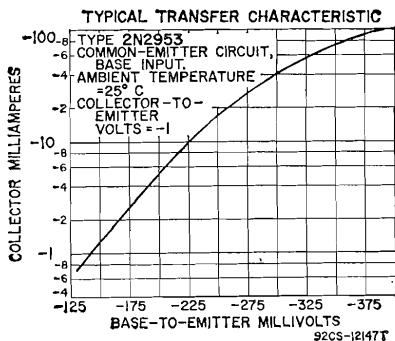

**POWER TRANSISTOR**

**2N3053/  
40053**

Silicon n-p-n type used in a wide variety of medium-power applications in industrial and commercial equipment. This type is intended primarily for frequencies up to 20 megacycles in small-signal power

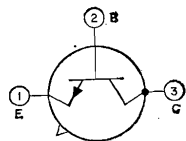

circuits. It is designed to assure freedom from second breakdown and features low leakage current and wide beta range. JEDEC No. TO-5 package; outline 6, Outlines Section.

**MAXIMUM RATINGS**

Collector-to-Base Voltage .....	60 max	volts
Collector-to-Emitter Voltage:		
With base open .....	40 max	volts
With external base-to-emitter resistance = 10 ohms .....	50 max	volts
With base-to-emitter volts = 1.5 volts .....	60 max	volts
Emitter-to-Base Voltage .....	5 max	volts
Collector Current .....	0.7 max	ampere
Transistor Dissipation:		
At case temperatures up to 25°C .....	5 max	watts
At case temperatures above 25°C .....	See curve	page 80
Temperature Range:		
Operating and Storage .....	-65 to 200	°C
Lead Temperature (for 10 seconds maximum) .....	235 max	°C

**CHARACTERISTICS**

Collector-to-Base Breakdown Voltage (with collector ma = 0.1)	60 min	volts
Collector-to-Emitter Sustaining Voltage:		
With external base-to-emitter resistance = 0 and collector ma = 100*	40 min	volts
With external base-to-emitter resistance = 10 ohms and collector ma = 100	50 min	volts
Collector-to-Emitter Saturation Voltage (with collector ma = 150 and base ma = 15)	1.4 max	volts
Base-to-Emitter Saturation Voltage (with collector ma = 150 and base ma = 15)	1.7 max	volts
Collector-Cutoff Current (with collector-to-base volts = 30 and emitter current = 0)	0.25 max	µa
Emitter-Cutoff Current (with emitter-to-base volts = 4 and collector current = 0)	0.25 max	µa
Thermal Resistance (junction-to-case)	35 max	°C/watt

*In Common-Base Circuit*

Emitter-to-Base Capacitance (with emitter-to-base volts = 0.5 and collector current = 0)	80 max	pf
Collector-to-Base Capacitance (with collector-to-base volts = 10 and emitter current = 0)	15 max	pf

*In Common-Emitter Circuit*

DC Forward Current-Transfer Ratio (with collector-to-emitter volts = 10 and pulsed collector ma = 150*)	50 to 250
Small-Signal Forward Current-Transfer Ratio (with collector-to-emitter volts = 10, collector ma = 50, and frequency = 20 Mc)	5 min

\* Pulse duration = 300 µsec; duty factor = 0.018.

TYPICAL COLLECTOR CHARACTERISTICS

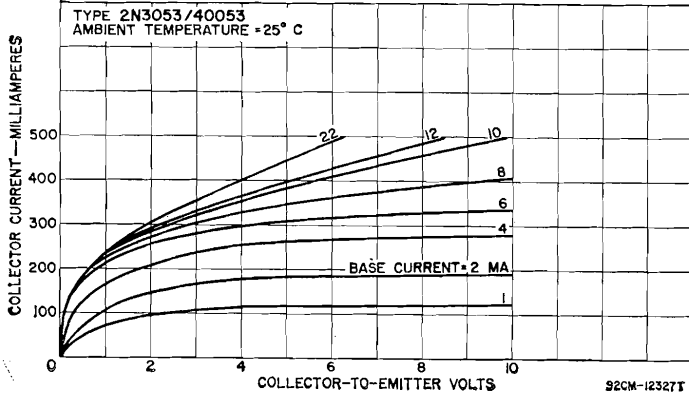

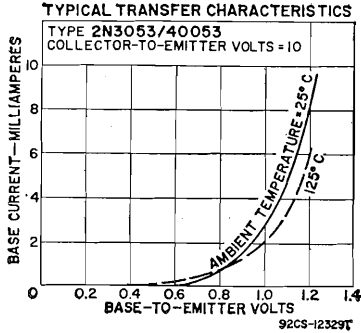

**POWER TRANSISTOR**

**2N3054**

Silicon n-p-n type used in a wide variety of intermediate-power applications in industrial and commercial equipment. This type is particularly useful in power-switching circuits, in series and shunt-regulator

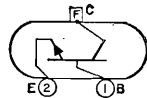

driver and output stages, and in high-fidelity amplifiers. It is designed to assure freedom from second breakdown and features a special package which permits convenient mounting and effective contact with the heat sink. Outline 33, Outlines Section.

**MAXIMUM RATINGS**

Collector-to-Base Voltage .....	90 max	volts
Collector-to-Emitter Voltage:		
With base open .....	55 max	volts
With external base-to-emitter resistance = 100 ohms .....	60 max	volts
With base-to-emitter volts = 1.5 volts .....	90 max	volts
Emitter-to-Base Voltage .....	7 max	volts
Collector Current .....	4 max	amperes
Base Current .....	2 max	amperes
Transistor Dissipation:		
At case temperatures up to 25°C .....	25 max	watts
At case temperatures above 25°C .....	See curve	page 80
Temperature Range:		
Operating and Storage .....	-65 to 200	°C
Lead Temperature (for 10 seconds maximum) .....	235 max	°C

**TYPICAL COLLECTOR CHARACTERISTICS**

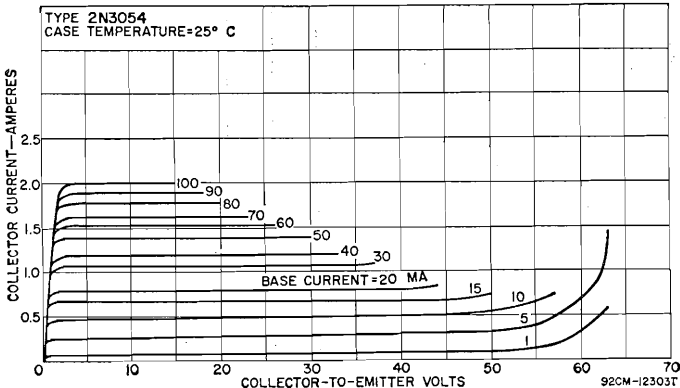



**CHARACTERISTICS**

Collector-to-Emitter Sustaining Voltage:	
With external base-to-emitter resistance = 0 and collector ma = 100	55 min volts
With external base-to-emitter resistance = 100 ohms and collector ma = 100	60 min volts
Collector-to-Emitter Saturation Voltage (with collector ma = 500 and base ma = 50)	1 max volts
Base-to-Emitter Saturation Voltage (with collector ma = 500 and collector-to-emitter volts = 4)	1.7 max volts
Emitter-Cutoff Current (with emitter-to-base volts = 7 and collector current = 0)	1 max ma
Thermal Resistance (junction-to-case)	7 max °C/watt

**In Common-Emitter Circuit**

DC Forward Current-Transfer Ratio (with collector-to-emitter volts = 4 and collector ma = 500) 25 to 100

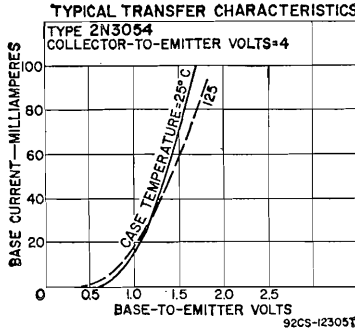

**POWER TRANSISTOR**

Silicon n-p-n type used in a wide variety of high-power applications in industrial and commercial equipment. This type is particularly useful in power-switching circuits in series and shunt-regulator driver

**2N3055**

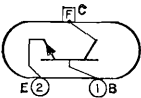

and output stages, and in high-fidelity amplifiers. It is designed to assure freedom from second breakdown and features an exceptionally high dissipation rating. JEDEC No. TO-3 package; outline 5, Outlines Section.

**MAXIMUM RATINGS**

Collector-to-Base Voltage	100 max volts
Collector-to-Emitter Voltage:	
With base open	60 max volts
With external base-to-emitter resistance = 100 ohms	70 max volts
With base-to-emitter volts = 1.5 volts	100 max volts
Emitter-to-Base Voltage	7 max volts
Collector Current	15 max amperes
Base Current	7 max amperes
Transistor Dissipation:	
At case temperatures up to 25°C	115 max watts
At case temperatures above 25°C	See curve page 80
Temperature Range:	
Operating and Storage	-65 to 200 °C
Lead Temperature (for 10 seconds maximum)	235 max °C

**CHARACTERISTICS**

Collector-to-Emitter Sustaining Voltage:	
With external base-to-emitter resistance = 0 and collector ma = 200	60 min volts
With external base-to-emitter resistance = 100 ohms and collector ma = 200	70 min volts

Collector-to-Emitter Saturation Voltage (with collector amperes = 4 and base ma = 400)	1.1 max	volts
Base-to-Emitter Saturation Voltage (with collector-to-emitter volts = 4, and collector amperes = 4)	1.8 max	volts
Emitter-Cutoff Current (with emitter-to-base volts = 7 and collector current = 0)	5 max	ma
Thermal Resistance (junction-to-case)	1.5 max	°C/watt

**In Common-Emitter Circuit**

DC Forward Current-Transfer Ratio (with collector-to-emitter volts = 4 and collector amperes = 4)	20 to 70
---	----------

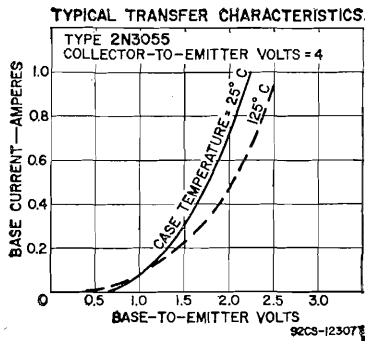
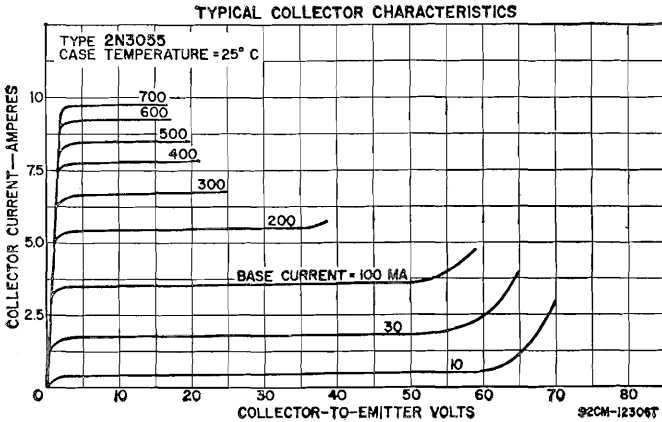

**TRANSISTOR**

**2N3118**

Silicon n-p-n type used in rf amplifiers in military and industrial high-frequency and vhf communication equipment. It is intended primarily for use in large-signal vhf class C and small-signal vhf class

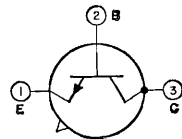

A amplifier circuits. This type features high output power, high collector-to-emitter voltage ratings, high gain-bandwidth product, high power gain, and high power dissipation. JEDEC No. TO-5 package; outline 6, Outlines Section.

**MAXIMUM RATINGS**

Emitter-to-Base Voltage .....	4 max	volts
Collector-to-Emitter Voltage:		
With base-to-emitter volts = -1.5 .....	85 max	volts
With base open .....	60 max	volts
Collector Current .....	0.5 max	ampere
Transistor Dissipation:		
At case temperatures up to 25°C .....	4 max	watts
At ambient temperatures up to 25°C .....	1 max	watts
At case or ambient temperatures above 25°C .....	See curve	page 80
Temperature Range:		
Operating (junction) and Storage .....	-65 to 200	°C
Lead Temperature (for 10 seconds maximum) .....	255 max	°C

**CHARACTERISTICS**

Emitter-to-Base Breakdown Voltage (with emitter ma = 0.1 and collector current = 0) .....	4 min	volts
Collector-to-Emitter Sustaining Breakdown Voltage (with pulsed collector ma = 10* and base current = 0) .....	60 min	volts
Collector-to-Emitter Breakdown Voltage (with base-to-emitter volts = -1.5 and collector ma = 0.1) .....	85 min	volts
Collector-Cutoff Current:		
With ambient temperature = 25°C, collector-to-base volts = 30, and emitter current = 0 .....	0.1 max	μa
With ambient temperature = 150°C, collector-to-base volts = 30, and emitter current = 0 .....	100 max	μa

*In Common-Base Circuit*

Collector-to-Base Capacitance (with collector-to-base volts = 28, emitter current = 0, and frequency = 1 Mc) .....	6 max	pf
--	-------	----

*In Common-Emitter Circuit*

DC Forward Current-Transfer Ratio (with collector-to-emitter volts = 28 and collector ma = 25) .....	50 to 275	
Small-Signal Forward Current-Transfer Ratio (with collector-to-emitter volts = 28, collector ma = 25, and frequency = 50 Mc) .....	5 min	
Output Power Class C Service**:		
With collector-to-emitter volts = 28, and frequency = 50 Mc .....	1 min	watt
With collector-to-emitter volts = 28, and frequency = 150 Mc .....	0.4 min	watt
Power Gain Class A Service† (with collector-to-emitter volts = 28, collector ma = 25, and frequency = 50 Mc) .....	18 min	db

\* Pulse duration = 300 μsec; duty factor = 0.018 or less.  
 \*\* Input power = 0.1 watt (with heat sink).  
 † Output power = 0.2 watt (with heat sink).

**TRANSISTOR**

**2N3119**

Silicon n-p-n type used in switching and pulse-amplifier applications. It is intended primarily for use in high-voltage high-frequency amplifiers and high-voltage saturation switches in military and industrial equipment.

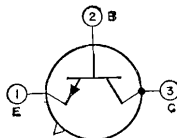

This type features high collector-to-emitter voltage ratings, fast rise time, and high power dissipation. JEDEC No. TO-5 package; outline 6, Outlines Section.

**MAXIMUM RATINGS**

Collector-to-Base Voltage .....	100 max	volts
Collector-to-Emitter Voltage:		
With base-to-emitter volts = -1.5 .....	100 max	volts
With base open .....	80 max	volts
Emitter-to-Base Voltage .....	4 max	volts
Collector Current .....	0.5 max	ampere
Transistor Dissipation:		
At case temperatures up to 25°C .....	4 max	watts
At ambient temperatures up to 25°C .....	1 max	watt
At case or ambient temperatures above 25°C .....	See curve	page 80
Temperature Range:		
Operating (junction) and Storage .....	-65 to 200	°C
Lead Temperature (for 10 seconds maximum) .....	255 max	°C

**CHARACTERISTICS**

Collector-to-Base Breakdown Voltage (with collector ma = 0.10 and emitter current = 0)	100 min	volts
Emitter-to-Base Breakdown Voltage (with emitter ma = 0.10* and collector current = 0)	4 min	volts
Collector-to-Emitter Breakdown Voltage (with base-to-emitter volts = 1.5 and collector ma = 0.1)	100 min	volts
Collector-to-Emitter Sustaining Breakdown Voltage (with pulsed collector ma = 10* and base current = 0)	80 min	volts
Collector-to-Emitter Saturation Voltage (with base ma = 10 and collector ma = 100)	0.5 max	volt
Base-to-Emitter Saturation Voltage (with base ma = 10 and collector ma = 100)	1.1 max	volt
Collector-Cutoff Current:		
With ambient temperature = 25°C, collector-to-base volts = 60, and emitter current = 0	50 max	na
With ambient temperature = 150°C, collector-to-base volts = 60, and emitter current = 0	50 max	μa
Emitter-Cutoff current (with ambient temperature = 25°C, emitter-to-base volts = 3, and collector current = 0)	100 max	na
Saturated Switching Turn-on Time (with collector supply volts = 28, base ma = 10, and collector ma = 100)	40 max	nsec
Saturated Switching Turn-off Time (with collector supply volts = 28, base ma = -10, and collector ma = 100)	700 max	nsec
Pulse-Amplifier Rise Time (with collector supply volts = 80 and collector ma = 10)	20 max	nsec

**In Common-Base Circuit**

Collector-to-Base Capacitance (with collector-to-base volts = 28, collector current = 0, and frequency = 1 Mc)	6 max	pf
--	-------	----

**In Common-Emitter Circuit**

DC Forward Current-Transfer Ratio:		
With collector-to-emitter volts = 10 and collector ma = 10	40 min	
With pulsed collector-to-emitter volts = 10* and collector ma = 100	50 to 200	
With pulsed collector-to-emitter volts = 10* and collector ma = 250	20 min	
Gain-Bandwidth Product (with collector-to-emitter volts = 28, collector ma = 25, and frequency = 50 Mc)	250 min	Mc

\* Pulse duration = 300 μsec; duty factor = 0.018.

**SILICON CONTROLLED RECTIFIER**

**2N3228**

Diffused-junction n-p-n-p type used in a wide variety of line-operated power-control and power-switching applications. It is particularly useful in 117-volt line power-controlled and power-switching

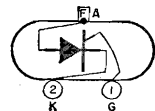

ing applications requiring a forward current of 3.2 amperes (average value) or 5 amperes (rms value). Outline 33, Outlines Section.

**MAXIMUM RATINGS**

*For sinusoidal ac supply voltage of 50 to 400 cps, with resistive or inductive load.*

Peak Reverse Voltage:		
Repetitive	200 max	volts
Non-repetitive	330 max	volts
Peak Forward Blocking Voltage (repetitive)	200 max	volts
Average Forward Current:		
At case temperature of 50°C and conduction angle of 180°	3.2 max	amperes
For other case temperatures and conduction angles	See Rating Chart I	
Peak Surge Current:		
For one cycle of applied voltage	60 max	amperes
For more than one cycle of applied voltage	See Rating Chart II	
Peak Forward Gate Current	2 max	amperes
Peak Gate Voltage:		
Forward	10 max	volts
Reverse	2 max	volts

Peak Gate Power .....	5 max	volts
Temperature Range:		
Operating (case) .....	-40 to 100	°C
Operating (ambient) .....	See Rating Chart III	°C
Storage .....	-40 to 125	°C

**CHARACTERISTICS**

Forward Breakover Voltage (at case temperature of 100°C) .....	200 min	volts
Forward Voltage Drop (at forward current = 3 amperes and case temperature = 25°C) .....	1.5 max	volts
Average Blocking Current (at case temperature of 50°C):		
Forward .....	1.5 max	ma
Reverse .....	1.5 max	ma
DC Gate-Trigger Current (at case temperature of 25°C) .....	15 max	ma

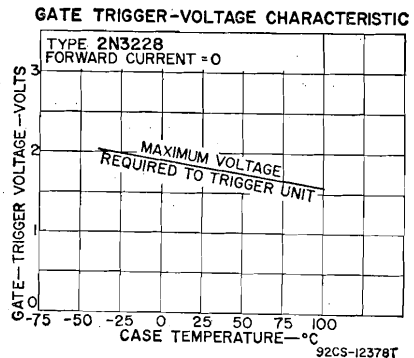
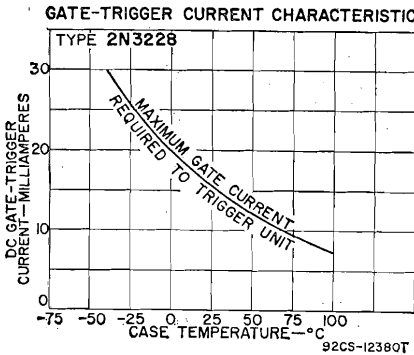
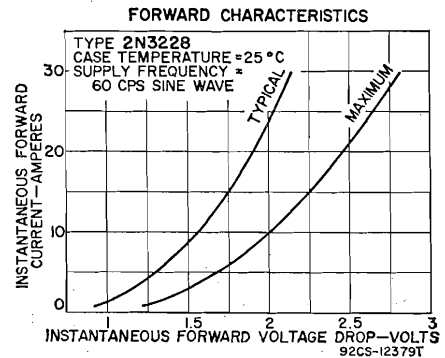
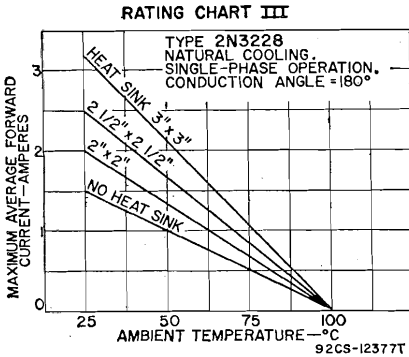
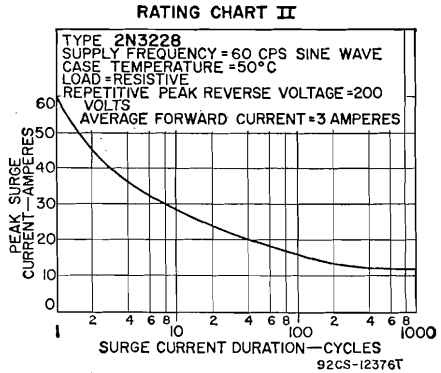
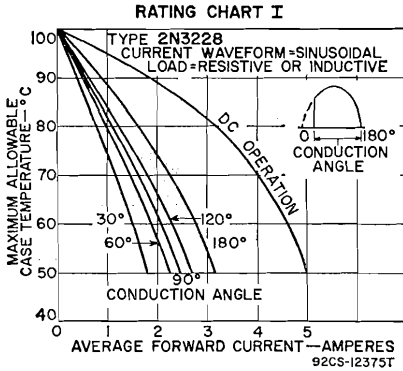

**POWER TRANSISTOR**

**2N3263**

Silicon n-p-n type used in a wide variety of aerospace, military, and industrial applications requiring a high degree of reliability. The high current-handling capability of this type and its fast switching speed

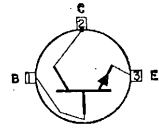

make it especially suitable in circuits where optimum circuit efficiency is desired. This type is used in switching-control amplifiers, power gates, switching regulators, dc-dc converters, dc-ac inverters, dc-rf amplifiers, and power oscillators. Outline 45, Outlines Section.

**MAXIMUM RATINGS**

Collector-to-Base Voltage .....	150 max	volts
Collector-to-Emitter Voltage (with emitter-to-base volts = -1.5) .....	150 max	volts
Collector-to-Emitter Sustaining Voltage:		
With base-to-emitter resistance = 50 ohms or less .....	110 max	volts
With base open .....	90 max	volts
Emitter-to-Base Voltage .....	7 max	volts
Collector Current .....	25 max	amperes
Base Current .....	10 max	amperes
Transistor Dissipation .....	See Dissipation Curve	
Temperature Range:		
Operating (junction) and Storage .....	-65 to 200	°C

**CHARACTERISTICS**

Emitter-to-Base Voltage (with emitter-to-base ampere = 0.02 and collector current = 0) .....	7 min	volts
Collector-to-Emitter Sustaining Voltage:		
With collector ampere = 0.2 and base current = 0 .....	90 min	volts
With external base-to-emitter resistance = 50 ohms or less, collector ampere = 0.2, and base current = 0 .....	110 min	volts
Collector-to-Emitter Saturation Voltage (with pulsed collector amperes = 15* and base amperes = 1.2) .....	0.75 max	volts
Base-to-Emitter Saturation Voltage (with pulsed collector amperes = 15* and base amperes = 1.2) .....	1.60 max	volts
Collector-Cutoff Current:		
With case temperature = 25°C, collector-to-base volts = 80, and base current = 0 .....	4 max	ma
With case temperature = 125°C, collector-to-base volts = 80, and base current = 0 .....	4 max	ma
Emitter-Cutoff Current:		
With case temperature = 25°C, emitter-to-base volts = 5, and collector current = 0 .....	5 max	ma
With case temperature = 125°C, emitter-to-base volts = 5, and collector current = 0 .....	5 max	ma
Collector Current (with base reversed biased, collector-to-emitter volts = 150, and emitter-to-base volts = 1.5) .....	20 max	ma
Thermal Resistance (with junction temperature = 100°C, collector-to-emitter volts = 40, and collector amperes = 0.5) .....	1.5 max	°C/watt
Saturated Switching Turn-on Time (with dc collector supply volts = 30, turn-on and turn-off base amperes = 1.2, and collector amperes = 15) .....	0.5 max	μsec
Saturated Switching Storage Time (with dc collector supply volts = 30, turn-on and turn-off base amperes = 1.2, and collector amperes = 15) .....	1.5 max	μsec
Saturated Switching Fall Time (with dc collector supply voltage = 30, turn-on and turn-off base amperes = 1.2, and collector amperes = 15) .....	0.5 max	μsec
Second Breakdown Characteristics (safe-operating region):		
Current at second breakdown with collector-to-emitter volts = 75 .....	350 min	ma
Energy at second breakdown with emitter-to-base volts = -6, collector amperes = 10, base-to-emitter resistance = 20 ohms, and inductance = 40 μh .....	2 min	mjoules

**In Common-Base Circuit**

Collector-to-Base Feedback Capacitance (with collector-to-base volts = 10, base current = 0, and frequency = 1 Mc) .....	900 max	pf
--	---------	----

In Common-Emitter Circuit

DC Forward Current-Transfer Ratio:

With collector-to-emitter volts = 3 and pulsed collector amperes = 5*	40 min	
With collector-to-emitter volts = 3 and pulsed collector amperes = 15*	25 to 75	
With collector-to-emitter volts = 4 and pulsed collector amperes = 20	20 min	
Gain-Bandwidth Product (with collector-to-emitter volts = 10, collector amperes = 3, and frequency = 5 Mc)	20 min	Mc

\*Pulse duration = 350  $\mu$ sec or less; duty factor = 0.02 or less.

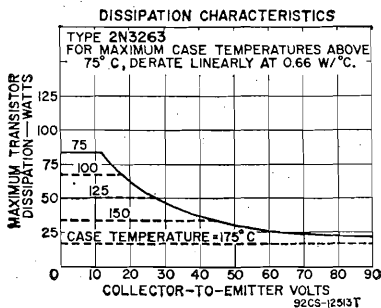
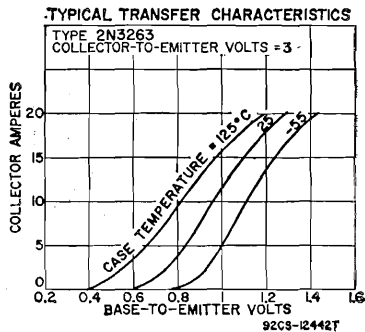
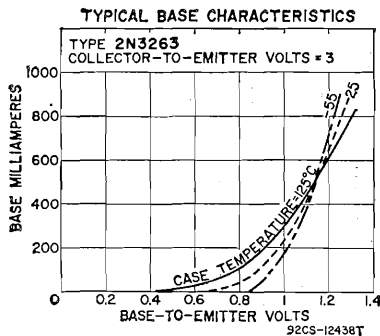

POWER TRANSISTOR

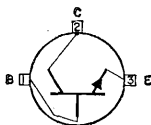

Silicon n-p-n type used in a wide variety of aerospace, military, and industrial applications requiring a high degree of reliability. The high current-handling capability of this type and its fast switching speed

**2N3264**

make it especially suitable in circuits where optimum circuit efficiency is desired. This type is used in switching-control amplifiers, power gates, switching regulators, dc-dc converters, dc-ac inverters, dc-rf amplifiers, and power oscillators. Outline 45, Outlines Section. For curves of transfer characteristics, refer to type 2N3263.

**MAXIMUM RATINGS**

Collector-to-Base Voltage .....	120 max	volts
Collector-to-Emitter Voltage (with emitter-to-base volts = -1.5) .....	120 max	volts
Collector-to-Emitter Sustaining Voltage:		
With base-to-emitter resistance = 50 ohms or less .....	80 max	volts
With base open .....	60 max	volts
Emitter-to-Base Voltage .....	7 max	volts
Collector Current .....	25 max	amperes
Base Current .....	10 max	amperes
Transistor Dissipation .....	See Dissipation Curve	
Temperature Range:		
Operating (junction) and Storage .....	-65 to 200	°C

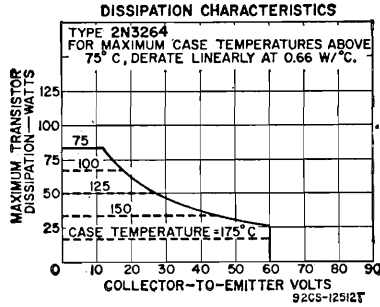

**CHARACTERISTICS**

Emitter-to-Base Voltage (with emitter-to-base ampere = 0.02 and collector current = 0) .....	7 min	volts
Collector-to-Emitter Sustaining Voltage:		
With collector ampere = 0.2 and base current = 0 .....	60 min	volts
With external base-to-emitter resistance = 50 ohms or less, collector ampere = 0.2, and base current = 0 .....	80 min	volts
Collector-to-Emitter Saturation Voltage (with pulsed collector amperes = 15* and base amperes = 1.2) .....	1.20 max	volts
Base-to-Emitter Saturation Voltage (with pulsed collector amperes = 15* and base amperes = 1.2) .....	1.80 max	volts
Collector-Cutoff Current:		
With case temperature = 25°C, collector-to-base volts = 60, and base current = 0 .....	10 max	ma
With case temperature = 125°C, collector-to-base volts = 60, and base current = 0 .....	10 max	ma
Emitter-Cutoff Current:		
With case temperature = 25°C, emitter-to-base volts = 5, and collector current = 0 .....	15 max	ma
With case temperature = 125°C, emitter-to-base volts = 5, and collector current = 0 .....	15 max	ma
Collector Current (with base reversed biased, collector-to-emitter volts = 120, and emitter-to-base volts = 1.5) .....	20 max	ma
Thermal Resistance (with junction temperature = 100°C, collector-to-emitter volts = 40, and collector amperes = 0.5) .....	1.5 max	°C/watt
Saturated Switching Turn-on Time (with dc collector supply volts = 30, turn-on and turn-off base amperes = 1.2, and collector amperes = 15) .....	0.5 max	μsec
Saturated Switching Storage Time (with dc collector supply volts = 30, turn-on and turn-off base amperes = 1.2, and collector amperes = 15) .....	1.5 max	μsec
Saturated Switching Fall Time (with dc collector supply voltage = 30, base amperes = 1.2, and collector amperes = 15) .....	0.5 max	μsec
Second Breakdown Characteristics (safe-operating region):		
Current at second breakdown with collector-to-emitter volts = 75 .....	700 min	ma
Energy at second breakdown with emitter-to-base volts = -6, collector amperes = 10, base-to-emitter resistance = 20 ohms, and inductance = 40 μh .....	2 min	mjoules

**In Common-Base Circuit**

Collector-to-Base Feedback Capacitance (with collector-to-base volts = 10, base current = 0, and frequency = 1 Mc) .....	900 max	pf
--	---------	----



In Common-Emitter Circuit

DC Forward Current-Transfer Ratio:

With collector-to-emitter volts = 3 and pulsed collector amperes = 5*	35	min
With collector-to-emitter volts = 3 and pulsed collector amperes = 15*	20 to 80	
With collector-to-emitter volts = 4 and pulsed collector amperes = 20	15 min	
Gain-Bandwidth Product (with collector-to-emitter volts = 10, collector amperes = 3, and frequency = 5 Mc)	20 min	Mc

\* Pulse duration = 350  $\mu$ sec or less; duty factor = 0.02 or less.

POWER TRANSISTOR

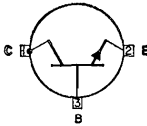

Silicon n-p-n type used in a wide variety of aerospace, military, and industrial applications requiring a high degree of reliability. The high current-handling capability of this type and its fast switching speed

2N3265

make it especially suitable in circuits where optimum circuit efficiency is desired. This type is used in switching-control amplifiers, power gates, switching regulators, dc-dc converters, dc-ac inverters, dc-rf amplifiers, and power oscillators. Outline 46, Outlines Section. This type is electrically identical with type 2N3263 except for the following items:

Transistor Dissipation	See Dissipation Curve
Thermal Resistance (with junction temperature = 100°C, collector-to-emitter volts = 40, and collector ampere = 0.5)	1 max °C/watt

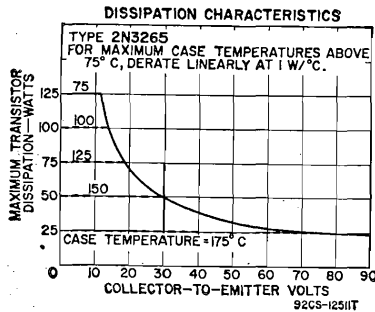

POWER TRANSISTOR

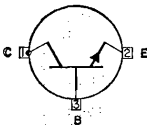

Silicon n-p-n type used in a wide variety of aerospace, military, and industrial applications requiring a high degree of reliability. The high current-handling capability of this type and its fast switching speed

2N3266

make it especially suitable in circuits where optimum circuit efficiency is desired. This type is used in switching-control amplifiers, power gates, switching regulators, dc-dc converters, dc-ac inverters, dc-rf amplifiers, and power os-

cillators. Outline 46, Outlines Section. This type is electrically identical with type 2N3264 except for the following items:

Transistor Dissipation .....	See Dissipation Curve
Thermal Resistance (with junction temperature = 100°C, collector-to-emitter volts = 40, and collector ampere = 0.5)	1 max °C/watt

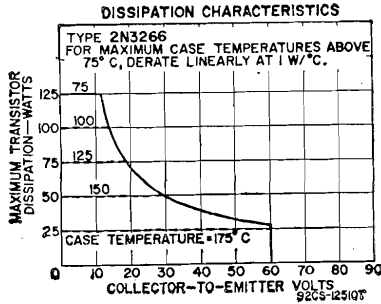

**TRIPLE DIODE**

**3DG001**

Hermetically sealed germanium type used in high-speed switching service in electronic data-processing systems. Package has the same dimensions as JEDEC No. TO-33; outline 13, Outlines Section. Diode units

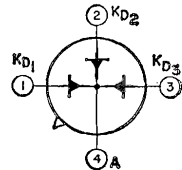

are identical with those of type 2DG001. This is a discontinued type listed for reference only.

**3746**

See List of Discontinued Transistors at end of Technical Data Section for abbreviated data.

**TRANSISTOR**

**3907/  
2N404**

Germanium p-n-p type used in critical switching applications in data-processing equipment. This premium type features excellent stability, reliability, and rugged construction. JEDEC No. TO-5 package;

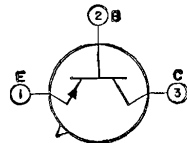

outline 6, Outlines Section.

**MAXIMUM RATINGS**

Collector-to-Base Voltage (with emitter open) .....	-25 max	volts
Collector-to-Emitter Voltage (with emitter-to-base volts = -1)	-24 max	volts
Emitter-to-Base Voltage (with collector open) .....	-12 max	volts
Collector Current .....	-200 max	ma
Emitter Current .....	200 max	ma
Transistor Dissipation:		
At ambient temperatures up to 25°C .....	150 max	mw
At ambient temperatures above 25°C .....	See curve page 80	
Ambient-Temperature Range:		
Operating .....	-65 to 85	°C
Storage .....	-65 to 100	°C
Lead Temperature (for 10 seconds maximum) .....	235 max	°C

**CHARACTERISTICS**

Base-to-Emitter Saturation Voltage:		
With collector ma = -12 and base ma = -0.4 .....	-0.35 max	volt
With collector ma = -24 and base ma = -1 .....	-0.4 max	volt
Collector-to-Emitter Saturation Voltage:		
With collector ma = -12 and base ma = -0.4 .....	-0.15 max	volt
With collector ma = -24 and base ma = -1 .....	-0.2 max	volt
Collector-Cutoff Current (with collector-to-base volts = -12 and emitter current = 0) .....	-5 max	$\mu$ a
Stored Base Charge (with collector ma = -10 and base ma = -1) .....	1400 max	peoul

**In Common-Base Circuit**

Small-Signal Forward-Current-Transfer-Ratio Cutoff Frequency (with collector-to-base volts = -6 and collector ma = -1) ..	4 min	Mc
Output Capacitance (with collector-to-base volts = -6 and emitter current = 0) .....	20 max	pf
Input Capacitance (with emitter-to-base volts = -6 and collector current = 0) .....	20 max	pf

**In Common-Emitter Circuit**

Forward Current-Transfer Ratio:		
With collector-to-emitter volts = -0.15 and collector ma = -12	30 min	
With collector-to-emitter volts = -0.2 and collector ma = -24	24 min	

**POWER TRANSISTOR**

Germanium p-n-p type used in high-fidelity audio-frequency amplifier applications. This type is intended primarily for use in push-pull class B output circuits requiring low distortion, high power output,

**40022**

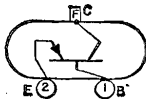

and wide frequency response. It can also be used in class A af power amplifiers in driver- or output-stage circuits. This type features high collector current and dissipation capabilities, and exceptional linearity of characteristics over the full range of collector current. JEDEC No. TO-3 package; outline 5, Outlines Section.

**MAXIMUM RATINGS**

Collector-to-Base Voltage .....	-32 max	volts
Collector-to-Emitter Voltage (with base-to-emitter resistance = 30 ohms) .....	-32 max	volts
Emitter-to-Base Voltage .....	-5 max	volts
Collector Current .....	-5 max	amperes
Base Current .....	-1 max	ampere
Transistor Dissipation:		
At mounting flange temperatures up to 81°C .....	12.5 max	watts
At mounting flange temperatures above 81°C .....	Derate 0.66 watt/°C	
Temperature Range:		
Operating (junction) and Storage .....	-65 to 100	°C
Lead Temperature (for 10 seconds maximum) .....	255 max	°C

**CHARACTERISTICS**

Collector-to-Base Breakdown Voltage (with collector ma = -5 and emitter current = 0) .....	-32 min	volts
Collector-to-Emitter Breakdown Voltage (with collector ma = -200 and base-to-emitter resistance = 30 ohms) .....	-32 min	volts
Emitter-to-Base Breakdown Voltage (with emitter ma = -200 and collector current = 0) .....	-5 min	volts
Base-to-Emitter Voltage (with collector-to-base volts = -10 and collector ma = -50) .....	-0.18	volt
Collector-Cutoff Current (with collector-to-base volts = -30 and emitter current = 0) .....	-1 max	ma
Collector-Cutoff Saturation Current (with collector-to-base volts = -0.5 and emitter current = 0) .....	-0.1 max	ma
Thermal Resistance (junction-to-case) .....	1.5 max	°C/watt

**In Common-Emitter Circuit**

Gain-Bandwidth Product (with collector-to-emitter volts = -5 and collector ampere = -0.5) .....	300	kilocycles
DC Forward Current-Transfer Ratio (with collector-to-emitter volts = -2 and collector amperes = 1) .....	50	

### TYPICAL OPERATION IN CLASS B PUSH-PULL AF AMPLIFIER CIRCUIT

DC Collector Supply Voltage	-14	volts
Zero-Signal DC Collector Current	-50	ma
Zero-Signal Base-Bias Voltage	-0.18	volt
Peak Collector Current	-2.25	amperes
Maximum-Signal DC Collector Current	-0.716	ampere
Input Impedance of Stage (per base)	43	ohms
Load Impedance (speaker voice coil)	4	ohms
Power Gain	24	db
Maximum-Signal Power Output	10	watts
Total Harmonic Distortion	5	per cent
Maximum Collector Dissipation (per transistor)	5	watts
EIA Music Power-Output Rating	18	watts

### TYPICAL OPERATION IN CLASS A AF-AMPLIFIER CIRCUIT

DC Collector Supply Voltage	-16	volts
DC Collector-to-Emitter Voltage	-13.2	volts
DC Collector Current	-0.9	ampere
Peak Collector Current	-1.8	amperes
Input Impedance	15	ohms
Collector Load Impedance	15	ohms
Maximum-Signal Power Output	5	watts
Total Harmonic Distortion	5	per cent
Power Gain	33	db
Maximum Collector Dissipation	12	watts

## POWER TRANSISTOR

# 40050

Germanium p-n-p type used in high-fidelity audio-frequency amplifier applications. This type is intended primarily for use in push-pull class B output circuits requiring low distortion and wide frequency

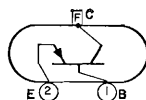

response. It can also be used in class A af power amplifiers in driver- or output-stage circuits. This type features high dc beta and linear gain characteristics up to five amperes. JEDEC No. TO-3 package; outline 5, Outlines Section.

### MAXIMUM RATINGS

Collector-to-Base Voltage	-40 max	volts
Collector-to-Emitter Voltage	-40 max	volts
Emitter-to-Base Voltage	-5 max	volts
Collector Current	-5 max	amperes
Base Current	-1 max	ampere
Transistor Dissipation:		
At mounting flange temperatures up to 81°C	12.5 max	watts
At mounting flange temperatures above 81°C	Derate 0.66	watt/°C
Temperature Range:		
Operating (junction) and Storage	-65 to 100	°C
Lead Temperature (for 10 seconds maximum)	255 max	°C

### CHARACTERISTICS

Collector-to-Base Breakdown Voltage (with collector ma = -5 and emitter current = 0)	-40 min	volts
Collector-to-Emitter Breakdown Voltage (with collector ma = -600 and base-to-emitter resistance = 68 ohms)	-40 min	volts
Emitter-to-Base Breakdown Voltage (with emitter ma = -2 and collector current = 0)	-5 min	volts
Base-to-Emitter Voltage (with collector-to-base volts = -10 and collector ma = -50)	0.17	volt
Collector-Cutoff Current (with collector-to-base volts = -30 and emitter current = 0)	-500 max	μa
Collector-Cutoff Saturation Current (with collector-to-base volts = -0.5 and emitter current = 0)	-100 ma	μa
Thermal Resistance (junction-to-case)	1.5 max	°C/watt

#### In Common-Emitter Circuit

Gain-Bandwidth Product (with collector-to-emitter volts = -5 and collector ampere = -0.5)	500	kilocycles
DC Forward Current-Transfer Ratio (with collector-to-emitter volts = -2 and collector amperes = 1)	50 min	

**TYPICAL OPERATION IN CLASS B PUSH-PULL AF AMPLIFIER CIRCUIT**

DC Collector Supply Voltage	-18	volts
Zero-Signal DC Collector Current	-50	ma
Zero-Signal Base-Bias Voltage	-0.17	volt
Peak Collector Current	-2.8	amperes
Maximum-Signal DC Collector Current	-0.8	ampere
Input Impedance of Stage (per base)	32	ohms
Load Impedance (speaker voice coil)	4	ohms
Power Gain	28	db
Maximum-Signal Power Output	15	watts
Total Harmonic Distortion	5	per cent
Maximum Collector Dissipation (per transistor)	7.5	watts
EIA Music-Power Output Rating	25	watts

**TYPICAL OPERATION IN CLASS A AF-AMPLIFIER CIRCUIT**

DC Collector Supply Voltage	-16	volts
DC Collector-Emitter Voltage	-13.2	volts
DC Collector Current	-0.9	ampere
Peak Collector Current	-1.8	ampere
Input Impedance	10	ohms
Collector Load Impedance	15	ohms
Maximum-Signal Power Output	5	watts
Total Harmonic Distortion	5	per cent
Power Gain	36	db
Maximum Collector Dissipation	12	watts

**POWER TRANSISTOR**

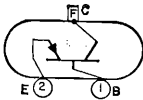

Germanium p-n-p type used in high-fidelity audio-frequency amplifier applications. This type is intended primarily for use in push-pull class B output circuits requiring low distortion and wide frequency

**40051**

response. It can also be used in class A af power amplifiers in driver- or output-stage circuits. This type features high dc beta and linear gain characteristics up to five amperes. JEDEC No. TO-3 package; outline 5, Outlines Section. This type is similar to type 40050 except for the following items:

**CHARACTERISTICS**

Collector-to-Base Breakdown Voltage	-50 min	volts
Collector-to-Emitter Breakdown Voltage	-50 min	volts

**TYPICAL OPERATION IN CLASS B PUSH-PULL AF AMPLIFIER CIRCUIT**

DC Collector Supply Voltage	-22	volts
Zero-Signal DC Collector Current	-50	ma
Zero-Signal Base-Bias Voltage	-0.17	volt
Peak Collector Current	-3.5	amperes
Maximum-Signal DC Collector Current	-1.1	amperes
Input Impedance of Stage (per stage)	31	ohms
Load Impedance (speaker voice coil)	4	ohms
Power Gain	28	db
Maximum-Signal Power Output	25	watts
Total Harmonic Distortion	5	per cent
Maximum Collector Dissipation (per transistor)	12.5	watts
EIA Music Power Output Rating	45	watts

See RCA TUNNEL DIODE CHART starting on page 324 for complete data on these tunnel diodes and rectifiers.

**40054  
to  
40070**

See RCA TUNNEL DIODE CHART starting on page 324 for complete data on these tunnel diodes.

**40076  
to  
40079**

**TRANSISTOR**

**40080**

Silicon n-p-n type designed specifically for use as an oscillator in 27-Mc 5-watt citizens band applications. JEDEC No. TO-39 package; outline 32, Outlines Section.

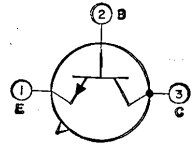

**MAXIMUM RATINGS**

Collector-to-Emitter Voltage (with base open) .....	30 max	volts
Collector Current .....	250 max	ma
Transistor Dissipation:		
At ambient temperatures up to 25°C .....	0.5 max	watt
At ambient temperatures above 25°C .....	See curve	page 80
Temperature Range:		
Operating (junction) and Storage .....	-65 to 175	°C

**CHARACTERISTICS**

Collector-to-Emitter Voltage (with collector ma = 10 and base current = 0) .....	30 min	volts
Collector-Cutoff Current (with collector-to-base volts = 15 and emitter current = 0) .....	10 max	μa

**TYPICAL OPERATION IN 27-MC RF OSCILLATOR CIRCUIT**

Power Output (with collector supply volts = 12 and maximum collector ma = 32) .....	100 min	mw
---	---------	----

**TRANSISTOR**

**40081**

Silicon n-p-n type designed specifically for use as a driver in 27-Mc 5-watt citizens band applications. JEDEC No. TO-39 package; outline 32, Outlines Section.

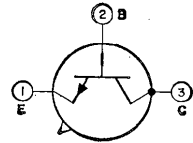

**MAXIMUM RATINGS**

Collector-to-Emitter Voltage (with reverse bias between base and emitter) .....	60 max	volts
Emitter-to-Base Voltage (with collector open) .....	2 max	volts
Collector Current .....	250 max	ma
Transistor Dissipation:		
At case temperatures up to 25°C .....	2 max	watts
At case temperatures above 25°C .....	See curve	page 80
Temperature Range:		
Operating (junction) and Storage .....	-65 to 175	°C

**CHARACTERISTICS**

Collector-to-Emitter Voltage (with base-to-emitter volts = -0.5 and collector μa = 100) .....	60 min	volts
Emitter-to-Base Voltage (with emitter μa = 500 and collector current = 0) .....	2 min	volts
Collector-Cutoff Current (with collector-to-base volts = 15 and emitter current = 0) .....	10 max	μa

**TYPICAL OPERATION IN 27-MC RF DRIVER CIRCUIT**

Power Output (with collector supply volts = 12, maximum collector ma = 85, and rf power input = 75 mw) .....	400 min	mw
--	---------	----

**TRANSISTOR**

**40082**

Silicon n-p-n type designed specifically for use as a power amplifier in 27-Mc 5-watt citizens band applications. JEDEC No. TO-39 package; outline 32, Outlines Section.

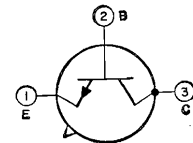

**MAXIMUM RATINGS**

Collector-to-Emitter Voltage (with reverse bias between base and emitter)	60 max	volts
Emitter-to-Base Voltage (with collector open)	2.5 max	volts
Collector Current	1.5 max	amperes
Transistor Dissipation:		
At case temperatures up to 25°C	5 max	watts
At case temperatures above 25°C	See curve	page 80
Temperature Range:		
Operating (junction) and Storage	-65 to 175	°C

**CHARACTERISTICS**

Collector-to-Emitter Voltage (with base-to-emitter volts = -0.5 and collector $\mu a = 500$ )	60 min	volts
Emitter-to-Base Voltage (with emitter $\mu a = 500$ and collector current = 0)	2.5 min	volts
Collector-Cutoff Current (with collector-to-base volts = 15 and emitter current = 0)	10 max	$\mu a$

**TYPICAL OPERATION IN 27-MC RF POWER-AMPLIFIER CIRCUIT**

Power Output (with collector supply volts = 12, maximum collector ma = 415, and rf power input = 350 mw)	3 min	watts
--	-------	-------

**TRANSISTOR**

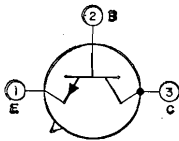

Silicon n-p-n type used in a wide variety of small-signal and medium-power applications in industrial equipment. This type features low noise and leakage characteristics, high pulse beta, high switching

**40084**

speeds, and a very low output capacitance. JEDEC No. TO-18 package; outline 12, Outlines Section.

**MAXIMUM RATINGS**

Collector-to-Base Voltage	60 max	volts
Collector-to-Emitter Voltage:		
With base open	40 max	volts
With base-to-emitter resistance = 10 ohms	50 max	volts
Emitter-to-Base Voltage	5 max	volts
Collector Current	1 max	ampere
Transistor Dissipation:		
At ambient temperatures up to 25°C	0.5 max	watt
At cas temperatures up to 25°C	1.8 max	watts
At ambient or case temperatures above 25°C	See curve	page 80
Temperature Range:		
Operating (junction) and Storage	-65 to 200	°C
Lead Temperature (for 10 seconds maximum)	225 max	°C

**CHARACTERISTICS**

Collector-to-Base Breakdown Voltage (with collector ma = 0.1)	60 min	volts
Emitter-to-Base Breakdown Voltage (with emitter ma = 0.1)	5 min	volts
Collector-to-Emitter Sustaining Voltage:		
With base open and pulsed collector ma = 100*	40 min	volts
With external base-to-emitter resistance = 10 ohms and pulsed collector ma = 100*	50 min	volts
Collector-to-Emitter Saturation Voltage (with pulsed collector ma = 150* and base ma = 15)	1.4 max	volts
Base-to-Emitter Saturation Voltage (with pulsed collector ma = 150* and base ma = 15)	1.7 max	volts
Collector-Cutoff Current (with collector-to-base volts = 30 and emitter current = 0)	0.25 max	$\mu a$
Emitter-Cutoff Current (with emitter-to-base volts = 4 and collector current = 0)	0.25 max	$\mu a$
Thermal Resistance:		
Junction-to-case	97 max	°C/watt
Junction-to-ambient	350 max	°C/watt

**In Common-Base Circuit**

Emitter-to-Base Capacitance (with emitter-to-base volt = 0.5 and collector current = 0)	80 max	pf
Collector-to-Base Capacitance (with collector-to-base volts = 10 and emitter current = 0)	15 max	pf

**In Common-Emitter Circuit**

DC Forward Current-Transfer Ratio (with collector-to-emitter volts = 10 and pulsed collector ma = 150*)	50 to 250	
Small-Signal Forward-Current-Transfer Ratio (with collector-to-emitter volts = 10, collector ma = 50, and frequency = 20 Mc)		5 min
Noise Figure (with collector-to-emitter volts = 10, collector ma = 0.3, generator resistance = 500 ohms, circuit bandwidth = 15 kilocycles, and input frequency = 1 kilocycle)		8 max db

\* Pulse duration = 300  $\mu$ sec; duty factor = 0.018.

**SILICON RECTIFIER**

**40108**

Hermetically sealed 10-ampere type for use at peak reverse voltages up to 50 volts. This type is used in generator-type power supplies in mobile equipment; dc-to-dc converters and battery chargers; power

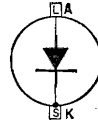

supplies for aircraft, marine, and missile equipment; transmitters, rf generators, and dc-motor power supplies; machine-tool controls; welding and electroplating equipment; dc-blocking service; magnetic amplifiers; and a wide variety of other industrial power-control applications. JEDEC No. DO-4 package; outline 2, Outlines Section.

**MAXIMUM RATINGS**

*For power-supply frequency of 60 cps, single-phase operation, with resistive or inductive load*

Peak Reverse Voltage	50 max	volts
DC Blocking Voltage	50 max	volts
Average Forward Current (at case temperature of 150°C)	10 max	amperes
Peak Recurrent Current	40 max	amperes
Peak Surge Current (at case temperature of 150°C)	140 max	amperes
Maximum Operating Temperature	175 max	°C

**CHARACTERISTICS**

Maximum Reverse Current:		
Static (at case temperature = 25°C)	0.075	ma
Dynamic (at case temperature = 150°C)	2.0	ma
Maximum Forward Voltage Drop (average value)	0.60	volt

**SILICON RECTIFIER**

**40108R**

This type is a reverse-polarity version of type 40108. JEDEC No. DO-4 package; outline 2, Outlines Section.

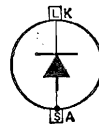

**SILICON RECTIFIER**

**40109**

Hermetically sealed 10-ampere type for use at peak reverse voltages up to 100 volts. This type is used in generator-type power supplies in mobile equipment; dc-to-dc converters and battery chargers; power sup-

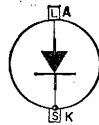

plies for aircraft, marine, and missile equipment; transmitters, rf generators, and dc-motor power supplies; machine-tool controls; welding and electroplating equipment; dc-blocking service; magnetic amplifiers; and a wide variety of other industrial power-control applications. JEDEC No. DO-4 package; outline 2, Outlines Section. This type is identical with type 40108 except for the following items:



**MAXIMUM RATINGS**

*For power-supply frequency of 60 cps, single-phase operation, with resistive or inductive load*

Peak Reverse Voltage .....	100 max	volts
DC Blocking Voltage .....	100 max	volts



**SILICON RECTIFIER**

This type is a reverse-polarity version of type 40109. JEDEC No. DO-4 package; outline 2, Outlines Section.

**40109R**

**SILICON RECTIFIER**

Hermetically sealed 10-ampere type for use at peak reverse voltages up to 200 volts. This type is used in generator-type power supplies in mobile equipment; dc-to-dc converters and battery chargers;

**40110**

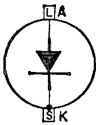

power supplies for aircraft, marine, and missile equipment; transmitters, rf generators, and dc-motor power supplies; machine-tool controls; welding and electroplating equipment; dc-blocking service; magnetic amplifiers; and a wide variety of other industrial power-control applications. JEDEC No. DO-4 package; outline 2, Outlines Section. This type is identical with type 40108 except for the following items:

**MAXIMUM RATINGS**

*For power-supply frequency of 60 cps, single-phase operation, with resistive or inductive load*

Peak Reverse Voltage .....	200 max	volts
DC Blocking Voltage .....	200 max	volts

**CHARACTERISTICS**

Maximum Reverse Current:		
Dynamic (at case temperature = 150°C) .....	1.5	ma

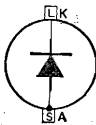

**SILICON RECTIFIER**

This type is a reverse-polarity version of type 40110. JEDEC No. DO-4 package; outline 2, Outlines Section.

**40110R**

**SILICON RECTIFIER**

Hermetically sealed 10-ampere type for use at peak reverse voltages up to 300 volts. This type is used in generator-type power supplies in mobile equipment; dc-to-dc converters and battery chargers;

**40111**

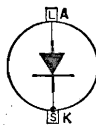

power supplies for aircraft, marine, and missile equipment; transmitters, rf generators, and dc-motor power supplies; machine-tool controls; welding and electroplating equipment; dc-blocking service; magnetic amplifiers; and a wide variety of other industrial power-control applications. JEDEC No. DO-4 package; outline 2, Outlines Section. This type is identical with type 40108 except for the following items:

**MAXIMUM RATINGS**

*For power-supply frequency of 60 cps, single-phase operation, with resistive or inductive load*

Peak Reverse Voltage .....	300 max	volts
DC Blocking Voltage .....	300 max	volts

**CHARACTERISTICS**

Maximum Reverse Current:		
Dynamic (at case temperature = 150°C) .....	1.5	ma

**SILICON RECTIFIER**

**40111R**

This type is a reverse-polarity version of type 40111. JEDEC No. DO-4 package; outline 2, Outlines Section.

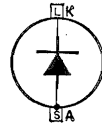

**SILICON RECTIFIER**

**40112**

Hermetically sealed 10-ampere type for use at peak reverse voltages up to 400 volts. This type is used in generator-type power supplies in mobile equipment; dc-to-dc converters and battery chargers;

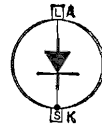

power supplies for aircraft, marine, and missile equipment; transmitters, rf generators, and dc-motor power supplies; machine-tool controls; welding and electroplating equipment; dc-blocking service; magnetic amplifiers; and a wide variety of other industrial power-control applications. JEDEC No. DO-4 package; outline 2, Outlines Section. This type is identical with type 40108 except for the following items:

**MAXIMUM RATINGS**

*For power-supply frequency of 60 cps, single-phase operation, with resistive or inductive load*

Peak Reverse Voltage .....	400 max	volts
DC Blocking Voltage .....	400 max	volts

**CHARACTERISTICS**

Maximum Reverse Current:		
Dynamic (at case temperature = 150°C) .....	1.0	ma

**SILICON RECTIFIER**

**40112R**

This type is a reverse-polarity version of type 40112. JEDEC No. DO-4 package; outline 2, Outlines Section.

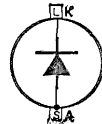

**SILICON RECTIFIER**

**40113**

Hermetically sealed 10-ampere type for use at peak reverse voltages up to 500 volts. This type is used in generator-type power supplies in mobile equipment; dc-to-dc converters and battery chargers;

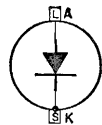

power supplies for aircraft, marine, and missile equipment; transmitters, rf generators, and dc-motor power supplies; machine-tool controls; welding and electroplating equipment; dc-blocking service; magnetic amplifiers; and a wide

variety of other industrial power-control applications. JEDEC No. DO-4 package; outline 2, Outlines Section. This type is identical with type 40108 except for the following items:

**MAXIMUM RATINGS**

*For power-supply frequency of 60 cps, single-phase operation, with resistive or inductive load*

Peak Reverse Voltage .....	500 max	volts
DC Blocking Voltage .....	500 max	volts

**CHARACTERISTICS**

Maximum Reverse Current:		
Dynamic (at case temperature = 150°C) .....	0.85	ma

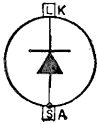

**SILICON RECTIFIER**

This type is a reverse-polarity version of type 40113. JEDEC No. DO-4 package; outline 2, Outlines Section.

**40113R**

**SILICON RECTIFIER**

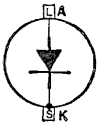

Hermetically sealed 10-ampere type for use at peak reverse voltages up to 600 volts. This type is used in generator-type power supplies in mobile equipment; dc-to-dc converters and battery chargers;

**40114**

power supplies for aircraft, marine, and missile equipment; transmitters, rf generators, and dc-motor power supplies; machine-tool controls; welding and electroplating equipment; dc-blocking service; magnetic amplifiers; and a wide variety of other industrial power-control applications. JEDEC No. DO-4 package; outline 2, Outlines Section. This type is identical with type 40108 except for the following items:

**MAXIMUM RATINGS**

*For power-supply frequency of 60 cps, single-phase operation, with resistive or inductive load*

Peak Reverse Voltage .....	600 max	volts
DC Blocking Voltage .....	600 max	volts

**CHARACTERISTICS**

Maximum Reverse Current:		
Dynamic (at case temperature = 150°C) .....	0.75	ma

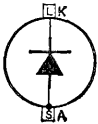

**SILICON RECTIFIER**

This type is a reverse-polarity version of type 40114. JEDEC No. DO-4 package; outline 2, Outlines Section.

**40114R**

**SILICON RECTIFIER**

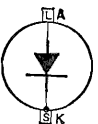

Hermetically sealed 10-ampere type for use at peak reverse voltages up to 800 volts. This type is used in generator-type power supplies in mobile equipment; dc-to-dc converters and battery chargers;

**40115**

power supplies for aircraft, marine, and missile equipment; transmitters, rf generators, and dc-motor power supplies; machine-tool controls; welding and

electroplating equipment; dc-blocking service; magnetic amplifiers; and a wide variety of other industrial power-control applications. JEDEC No. DO-4 package; outline 2, Outlines Section. This type is identical with type 40108 except for the following items:

**MAXIMUM RATINGS**

*For power-supply frequency of 60 cps, single-phase operation, with resistive or inductive load*

Peak Reverse Voltage .....	800 max	volts
DC Blocking Voltage .....	800 max	volts

**CHARACTERISTICS**

Maximum Reverse Current:		
Dynamic (at case temperature = 150°C) .....	0.65	ma

**SILICON RECTIFIER**

**40115R**

This type is a reverse-polarity version of type 40115. JEDEC No. DO-4 package; outline 2, Outlines Section.

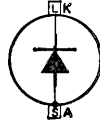

**SILICON RECTIFIER**

**40116**

Hermetically sealed 10-ampere type for use at peak reverse voltages up to 1000 volts. This type is used in generator-type power supplies in mobile equipment; dc-to-dc converters and battery chargers;



power supplies for aircraft, marine, and missile equipment; transmitters, rf generators, and dc-motor power supplies; machine-tool controls; welding and electroplating equipment; dc-blocking service; magnetic amplifiers; and a wide variety of other industrial power-control applications. JEDEC No. DO-4 package; outline 2, Outlines Section. This type is identical with type 40108 except for the following items:

**MAXIMUM RATINGS**

*For power-supply frequency of 60 cps, single-phase operation, with resistive or inductive load*

Peak Reverse Voltage .....	1000 max	volts
DC Blocking Voltage .....	1000 max	volts

**CHARACTERISTICS**

Maximum Reverse Current:		
Dynamic (at case temperature = 150°C) .....	0.50	ma

**SILICON RECTIFIER**

**40116R**

This type is a reverse-polarity version of type 40116. JEDEC No. DO-4 package; outline 2, Outlines Section.

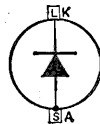

**SILICON RECTIFIER**

**40208**

Hermetically sealed 18-ampere type for use at peak reverse volts up to 50 volts. This type is used in generator-type power supplies in mobile equipment; dc-to-dc converters and battery chargers; power

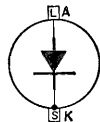

supplies for aircraft, marine, and missile equipment; transmitters, rf generators, and dc-motor power supplies; machine-tool controls; welding and elec-

troplating equipment; dc-blocking service; magnetic amplifiers; and a wide variety of other industrial power-control applications. JEDEC No. DO-5 package; outline 3, Outlines Section.

**MAXIMUM RATINGS**

Peak Reverse Voltage .....	50 max	volts
DC Blocking Voltage .....	50 max	volts
Average Forward Current (at case temperature = 150°C) .....	18 max	amperes
Peak Recurrent Current .....	72 max	amperes
Peak Surge Current (at case temperature = 150°C) .....	250 max	amperes
Maximum Operating Temperature .....	175 max	°C

**CHARACTERISTICS**

Maximum Reverse Current:		
Static (at case temperature = 25°C) .....	0.10	ma
Dynamic (at case temperature = 150°C) .....	3.0	ma
Maximum Forward Voltage Drop (average value) .....	0.65	volt

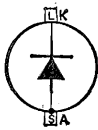

**SILICON RECTIFIER**

This type is a reverse-polarity version of type 40208. JEDEC No. DO-5 package; outline 3, Outlines Section.

**40208R**

**SILICON RECTIFIER**

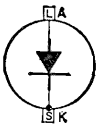

Hermetically sealed 18-ampere type for use at peak reverse volts up to 100 volts. This type is used in generator-type power supplies in mobile equipment; dc-to-dc converters and battery chargers; power supplies

**40209**

for aircraft, marine, and missile equipment; transmitters, rf generators, and dc-motor power supplies; machine-tool controls; welding and electroplating equipment; dc-blocking service; magnetic amplifiers; and a wide variety of other industrial power-control applications. JEDEC No. DO-5 package; outline 3, Outlines Section. This type is identical with type 40208 except for the following items:

**MAXIMUM RATINGS**

Peak Reverse Voltage .....	100 max	volts
DC Blocking Voltage .....	100 max	volts

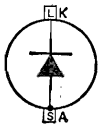

**SILICON RECTIFIER**

This type is a reverse-polarity version of type 40209. JEDEC No. DO-5 package; outline 3, Outlines Section.

**40209R**

**SILICON RECTIFIER**

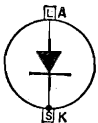

Hermetically sealed 18-ampere type for use at peak reverse volts up to 200 volts. This type is used in generator-type power supplies in mobile equipment; dc-to-dc converters and battery chargers; power

**40210**

supplies for aircraft, marine, and missile equipment; transmitters, rf generators, and dc-motor power supplies; machine-tool controls; welding and electroplating equipment; dc-blocking service; magnetic amplifiers; and a wide variety of other industrial power-control applications. JEDEC No. DO-5 pack-

age; outline 3, Outlines Section. This type is identical with type 40208 except for the following items:

**MAXIMUM RATINGS**

Peak Reverse Voltage .....	200 max	volts
DC Blocking Voltage .....	200 max	volts

**CHARACTERISTICS**

Maximum Reverse Current:		
Dynamic (at case temperature = 150°C) .....	2.5	ma

**SILICON RECTIFIER**

**40210R**

This type is a reverse-polarity version of type 40210. JEDEC No. DO-5 package; outline 3, Outlines Section.

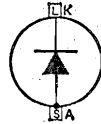

**SILICON RECTIFIER**

**40211**

Hermetically sealed 18-ampere type for use at peak reverse volts up to 300 volts. This type is used in generator-type power supplies in mobile equipment; dc-to-dc converters and battery chargers; power

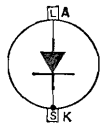

supplies for aircraft, marine, and missile equipment; transmitters, rf generators, and dc-motor power supplies; machine-tool controls; welding and electroplating equipment; dc-blocking service; magnetic amplifiers; and a wide variety of other industrial power-control applications. JEDEC No. DO-5 package; outline 3, Outlines Section. This type is identical with type 40208 except for the following items:

**MAXIMUM RATINGS**

Peak Reverse Voltage .....	300 max	volts
DC Blocking Voltage .....	300 max	volts

**CHARACTERISTICS**

Maximum Reverse Current:		
Dynamic (at case temperature = 150°C) .....	2.5	ma

**SILICON RECTIFIER**

**40211R**

This type is a reverse-polarity version of type 40211. JEDEC No. DO-5 package; outline 3, Outlines Section.

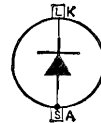

**SILICON RECTIFIER**

**40212**

Hermetically sealed 18-ampere type for use at peak reverse volts up to 400 volts. This type is used in generator-type power supplies in mobile equipment; dc-to-dc converters and battery chargers; power

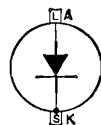

supplies for aircraft, marine, and missile equipment; transmitters, rf generators, and dc-motor power supplies; machine-tool controls; welding and electroplating equipment; dc-blocking service; magnetic amplifiers; and a wide variety of other power-control applications. JEDEC No. DO-5 package; outline

3, Outlines Section. This type is identical with type 40208 except for the following items:

**MAXIMUM RATINGS**

Peak Reverse Voltage .....	400 max	volts
DC Blocking Voltage .....	400 max	volts

**CHARACTERISTICS**

Maximum Reverse Current:		
Dynamic (at case temperature = 150°C) .....	2.0	ma

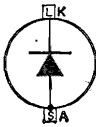

**SILICON RECTIFIER**

This type is a reverse-polarity version of type 40212. JEDEC No. DO-5 package; outline 3, Outlines Section.

**40212R**

**SILICON RECTIFIER**

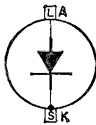

Hermetically sealed 18-ampere type for use at peak reverse volts up to 500 volts. This type is used in generator-type power supplies in mobile equipment; dc-to-dc converters and battery chargers; power

**40213**

supplies for aircraft, marine, and missile equipment; transmitters, rf generators, and dc-motor power supplies; machine-tool controls; welding and electroplating equipment; dc-blocking service; magnetic amplifiers; and a wide variety of other industrial power-control applications. JEDEC No. DO-5 package; outline 3, Outlines Section. This type is identical with type 40208 except for the following items:

**MAXIMUM RATINGS**

Peak Reverse Voltage .....	500 max	volts
DC Blocking Voltage .....	500 max	volts

**CHARACTERISTICS**

Maximum Reverse Current:		
Dynamic (at case temperature = 150°C) .....	1.75	ma

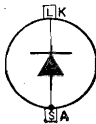

**SILICON RECTIFIER**

This type is a reverse-polarity version of type 40213. JEDEC No. DO-5 package; outline 3, Outlines Section.

**40213R**

**SILICON RECTIFIER**

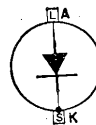

Hermetically sealed 18-ampere type for use at peak reverse volts up to 600 volts. This type is used in generator-type power supplies in mobile equipment; dc-to-dc converters and battery chargers; power

**40214**

supplies for aircraft, marine, and missile equipment; transmitters, rf generators, and dc-motor power supplies; machine-tool controls; welding and electroplating equipment; dc-blocking service; magnetic amplifiers; and a wide variety of other industrial power-control applications. JEDEC No. DO-5 pack-

age; outline 3, Outlines Section. This type is identical with type 40208 except for the following items:

### MAXIMUM RATINGS

Peak Reverse Voltage .....	600 max	volts
DC Blocking Voltage .....	600 max	volts

### CHARACTERISTICS

Maximum Reverse Current:		
Dynamic (at case temperature = 150°C) .....	1.5	ma

## SILICON RECTIFIER

# 40214R

This type is a reverse-polarity version of type 40214. JEDEC No. DO-5 package; outline 3, Outlines Section.

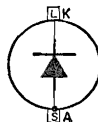

## SILICON CONTROLLED RECTIFIER

# 40216

Diffused-junction n-p-n-p type used in a wide variety of high-current pulse applications. This type is designed to meet stringent military environmental and mechanical specifications. The special high-strength

copper alloy stud can withstand an installing torque up to 50 inch-pounds. JEDEC No. TO-48 package; outline 19, Outlines Section.

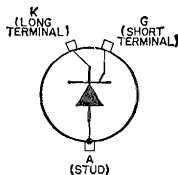

### MAXIMUM RATINGS

Peak Reverse Voltage:		
Repetitive .....	600 max	volts
Non-repetitive .....	720 max	volts
Peak Forward Blocking Voltage (repetitive) .....	600 max	volts
Peak Forward Gate Current .....	2 max	amperes
Peak Gate Voltage:		
Forward .....	10 max	volts
Reverse .....	5 max	volts
Peak Gate Power .....	5 max	watts
Average Gate Power .....	0.5 max	watt
Temperature Range:		
Operating (case) .....	-65 to 125	°C
Storage .....	-65 to 150	°C

### CHARACTERISTICS

Forward Breakover Voltage (at case temperature of 125°C) ..	600 min	volts
DC Gate-Trigger Voltage:		
At case temperature of -40°C .....	3.5 max	volts
At case temperature of -65°C .....	3.7 max	volts
At case temperature of 100°C .....	0.3 min	volt
At case temperature of 125°C .....	0.25 min	volt
Instantaneous Blocking Current (at case temperature of 125°C):		
Forward .....	10 max	ma
Reverse .....	10 max	ma
DC Gate-Trigger Current:		
At case temperature of -65°C .....	150 max	ma
At case temperature of 25°C .....	80 max	ma
At case temperature of 125°C .....	45 max	ma
Holding Current (at case temperature of 125°C) .....	8	ma
Thermal Resistance (junction-to-case) .....	2 max	°C/watt



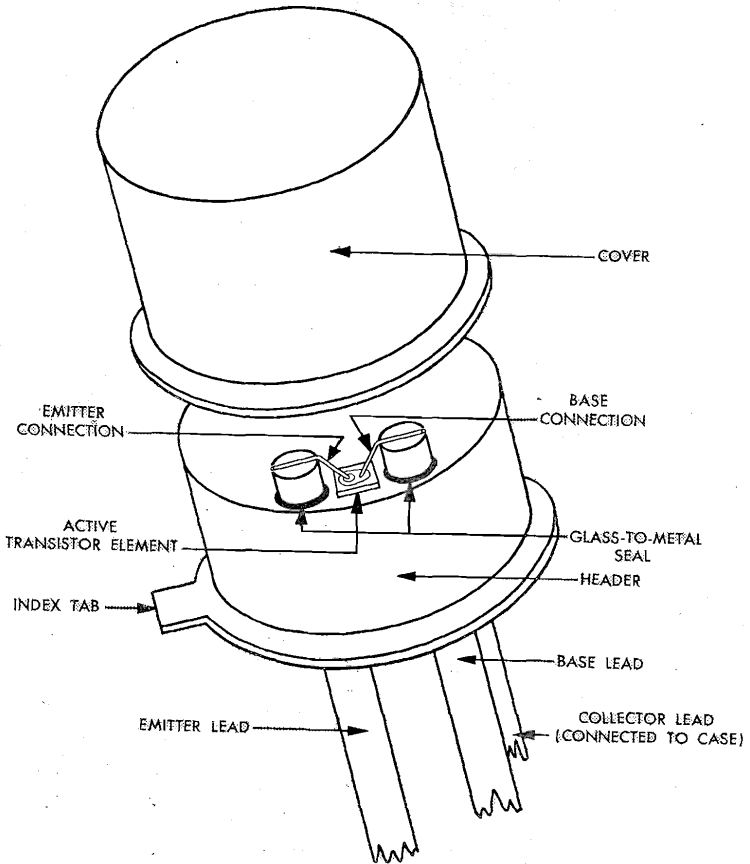

**TYPICAL SILICON SWITCHING TRANSISTOR**

## SILICON RECTIFIERS

### CR101 SERIES

Hermetically sealed types used in power-supply applications at peak reverse voltages up to 10,000 volts. These types consist of series-connected silicon rectifier cells shunted by a voltage-equalizing

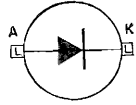

network and molded into a compact, rugged case of insulating material. The integral resistance-capacitance network equalizes the reverse voltages across the rectifier cells under both steady-state and transient conditions. These types are designed to meet stringent environmental and mechanical specifications. Outline 29, Outlines Section.

#### Common Parameters

Peak Recurrent Current .....	5 amperes
Surge Current* .....	15 amperes
Maximum Reverse Current:	
Dynamic (for complete cycle and for operation at maximum ratings) .....	0.3 ma
Static (at maximum rated dc blocking voltage and any temperature within the operating temperature range) .....	0.6 ma
Ambient Temperature Range (operating and storage) .....	-65 to 125°C

MAXIMUM RATINGS (Half-wave Rectifier Service)						CHARACTERISTICS	
RCA Type	For power-supply frequency of 60 cps, single-phase operation, with resistive or inductive load					Max Forward Voltage Drop† (volts)	Shunt Capacitance (pt)
	Peak Reverse Voltage (volts)	Transient Reverse Voltage** (volts)	RMS Supply Voltage (volts)	DC Blocking Voltage (volts)	Average Forward Current‡ (ma)		
CR101	1200	1440	840	1200	850	1.2	350-600
CR102	2000	2400	1400	2000	825	2.4	175-320
CR103	3000	3600	2100	3000	725	3.0	140-250
CR104	4000	4800	2800	4000	625	4.2	100-175
CR105	5000	6000	3500	5000	625	4.8	85-160
CR106	6000	7200	4200	6000	575	6.0	70-125
CR107	7000	8400	4900	7000	550	7.2	60-105
CR108	8000	9600	5600	8000	550	7.8	55-100
CR109	9000	10800	6300	9000	550	9.0	45-90
CR110	10000	12000	7000	10000	550	9.6	40-80

\* For one-half cycle, sine-wave; for one or more cycles, see Rating Chart I. Superimposed on device operating within maximum voltage, current, and temperature ratings; may be repeated after sufficient time has elapsed for the device to return to the presurge thermal-equilibrium conditions.

\*\* Non-repetitive, for duration of 5 milliseconds maximum. The value given is for ambient temperatures from 60 to 125°C; for ambient temperatures up to 60°C, see Rating Chart II.

† For ambient temperatures up to 60°C; for temperatures above 60°C, see Rating Chart III.

‡ For complete cycle and for operation at maximum ratings. For instantaneous forward-voltage drop, see Instantaneous Forward Characteristics Curve.

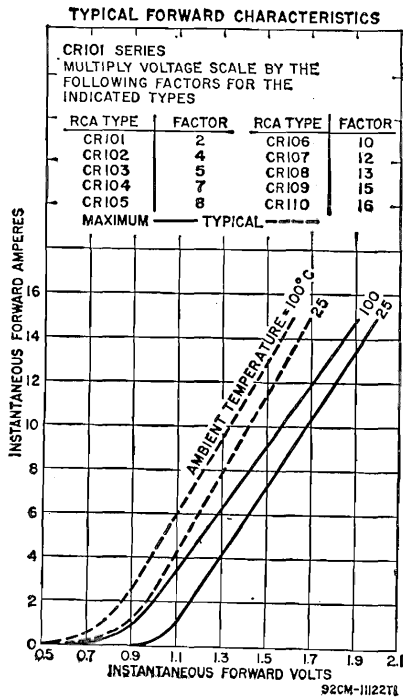
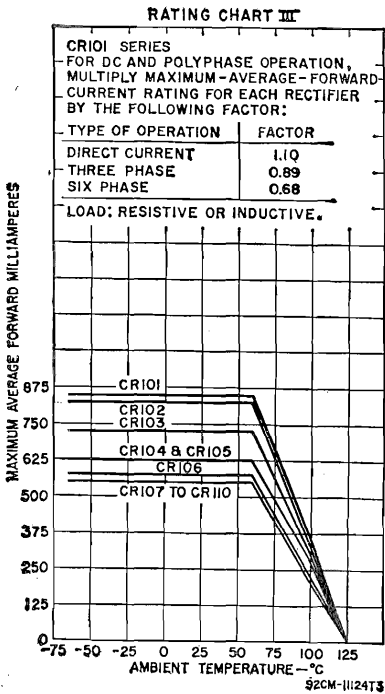
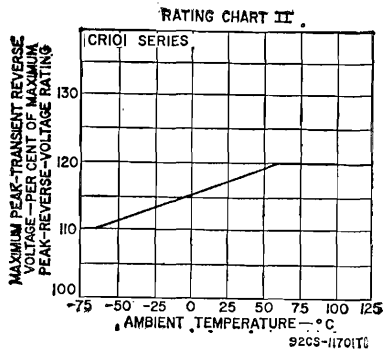
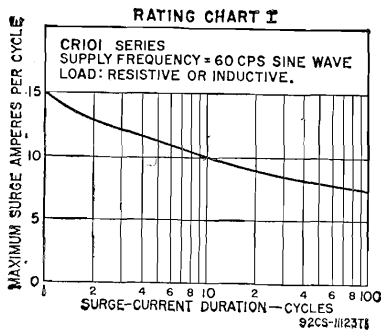

## SILICON RECTIFIERS

### CR201 SERIES

Hermetically sealed types used in power-supply applications at peak reverse voltages up to 12,000 volts. These types consist of series-connected, matched silicon rectifier cells molded into a compact, rugged

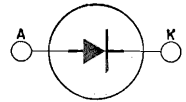

case of insulating material. The matched cells assure equalization of internal voltages under both steady-state and transient conditions. These types are designed to meet stringent environmental and mechanical specifications. Outline 30, Outlines Section.

#### Common Parameters

Average Forward Current*	300	ma
Peak Recurrent Current	3	amperes
Surge Current**	9	amperes
Maximum Reverse Current:		
Dynamic (for complete cycle and for operation at maximum ratings at 100°C)	0.1	ma
Static at maximum rated dc blocking voltage and any temperature within the operating range:		
25°C	0.01	ma
100°C	0.2	ma
Ambient Temperature Range (operating and storage)	-65 to 125°C	

MAXIMUM RATINGS (Half-wave Rectifier Service)					CHARACTERISTICS
RCA Type	For power-supply frequency of 60 cps, single-phase operation, with resistive or inductive load				Max Forward Voltage Drop‡ (volts)
	Peak Reverse Voltage (volts)	Transient Reverse Voltage† (volts)	RMS Supply Voltage (volts)	DC Blocking Voltage (volts)	
CR201	1500	1800	1060	1500	1.8
CR203	3000	3600	2120	3000	3
CR204	4500	5400	3180	4500	3.6
CR206	6000	7200	4240	6000	6
CR208	8000	9600	5650	8000	6
CR210	10000	12000	7070	10000	7.2
CR212	12000	14400	8480	12000	9

\* For ambient temperatures up to 60°C; for temperatures above 60°C, see Rating Chart I.  
 \*\* For one-half cycle, sine wave; for one or more cycles, see Rating Chart II. Superimposed on device operating within maximum voltage, current, and temperature ratings; may be repeated after sufficient time has elapsed for the device to return to the presurge thermal-equilibrium conditions.

† Non-repetitive, for duration of 5 milliseconds maximum. The value given is for ambient temperature from 60 to 125°C; for ambient temperatures up to 60°C, see Rating Chart III.

‡ For complete cycle and for operation at maximum ratings. For instantaneous forward voltage drop, see Instantaneous Forward Characteristics Curve.

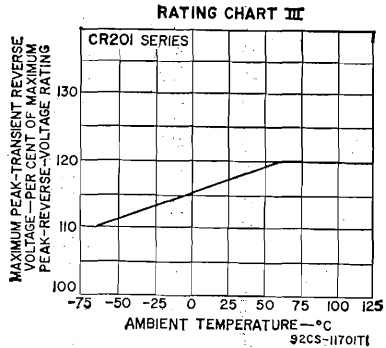
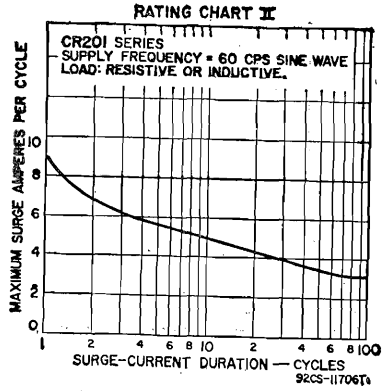
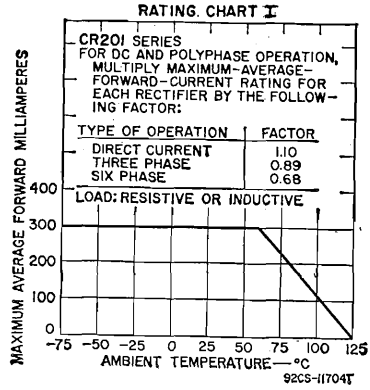
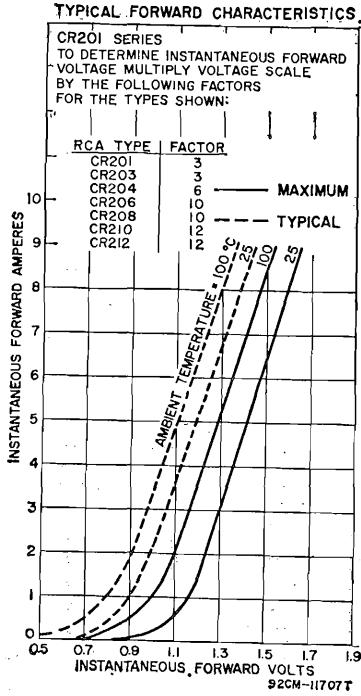

## SILICON RECTIFIERS

### CR301 SERIES

Hermetically sealed fin-mounted types used in power-supply applications at peak reverse voltages up to 9600 volts. These types consist of series-connected silicon rectifier cells shunted by a voltage-equaliz-

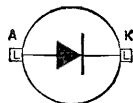

ing network. The integral resistance-capacitance network equalizes the reverse voltages across the rectifier cells under both steady-state and transient conditions. These types are designed to meet stringent environmental and mechanical specifications. For instantaneous forward voltage drop for these types, see Instantaneous Forward Characteristics Curve. Outline 47, Outlines Section.

#### Common Parameters

##### Maximum Reverse Current:

Dynamic (for complete cycle and for operation at maximum ratings) ..... 1.5 ma

Static (at maximum rated dc blocking voltage and any temperature within the operating temperature range) ..... 2.0 ma

Shunt Capacitance ..... 0.01  $\mu$ f

Ambient Temperature Range (operating and storage) ..... -55 to 125°C

#### MAXIMUM RATINGS (Half-wave Rectifier Service)

RCA Type	No. of Cells	For power-supply frequency of 60 cps, single-phase operation, with resistive or inductive load						
		Peak Reverse Voltage (volts)	Transient Reverse Voltage* (volts)	RMS Voltage (volts)	DC Blocking Voltage (volts)	Average Forward Current** (amperes)	RMS Forward Current (amperes)	Surge Current† (amperes)
CR301	4	2400	2880	1695	2400	5	7.8	250
CR302	6	3600	4320	2545	3600	5	7.8	250
CR303	8	4800	5760	3395	4800	5	7.8	250
CR304	10	6000	7200	4240	6000	5	7.8	250
CR305	12	7200	8640	5090	7200	5	7.8	250
CR306	14	8400	10080	5935	8400	5	7.8	250
CR307	16	9600	11520	6785	9600	5	7.8	250
CR311	4	2400	2880	1695	2400	9	14	250
CR312	6	3600	4320	2545	3600	9	14	250
CR313	8	4800	5760	3395	4800	9	14	250
CR314	10	6000	7200	4240	6000	9	14	250
CR315	12	7200	8640	5090	7200	9	14	250
CR316	14	8400	10080	5935	8400	9	14	250
CR317	16	9600	11520	6785	9600	9	14	250
CR321	4	2400	2880	1695	2400	12	18.8	400
CR322	6	3600	4320	2545	3600	12	18.8	400
CR323	8	4800	5760	3395	4800	12	18.8	400
CR324	10	6000	7200	4240	6000	12	18.8	400
CR325	12	7200	8640	5090	7200	12	18.8	400
CR331	4	2400	2880	1695	2400	17	26.5	400

RCA Type	No. of Cells	Peak Reverse Voltage (volts)	Transient Reverse Voltage* (volts)	RMS Voltage (volts)	DC Blocking Voltage (volts)	Average Forward Current** (amperes)	RMS Forward Current (amperes)	Surge Current† (amperes)
CR332	6	3600	4320	2545	3600	17	26.5	400
CR333	8	4800	5760	3395	4800	17	26.5	400
CR334	10	6000	7200	4240	6000	17	26.5	400
CR335	12	7200	8640	5090	7200	17	26.5	400
CR341	4	2400	2880	1695	3600	23	36	850
CR342	6	3600	4320	2545	4800	23	36	850
CR343	8	4800	5760	3395	6000	23	36	850
CR344	10	6000	7200	4240	2400	23	36	850
CR351	4	2400	2880	1695	3600	35	55	850
CR352	6	3600	4320	2545	4800	35	55	850
CR353	8	4800	5760	3395	6000	35	55	850
CR354	10	6000	7200	4240	2400	35	55	850

\* Non-repetitive, for duration of 5 milliseconds maximum. The value given is for ambient temperatures from 50 to 125°C; for ambient temperatures up to 50°C, see Rating Chart I on page 322.

\*\* For ambient temperatures up to 50°C; for temperatures above 50°C, see Rating Chart II on page 322.

† For one-half cycle, sine-wave; for one or more cycles, see Rating Chart III. Superimposed on device operating within maximum voltage, current, and temperature ratings; may be repeated after sufficient time has elapsed for the device to return to the presurge thermal-equilibrium conditions.

RATING CHART III

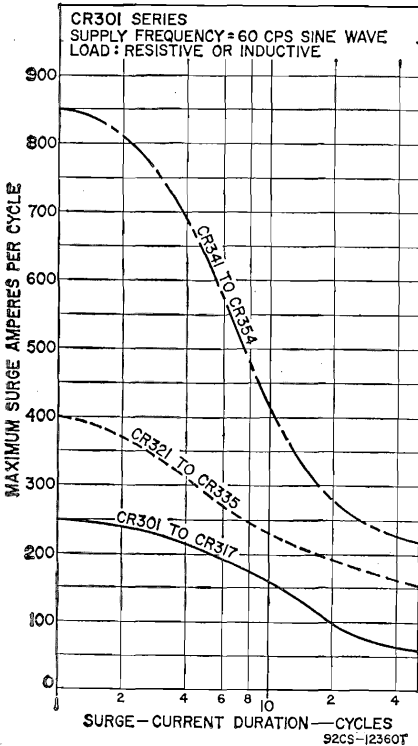

FORWARD CHARACTERISTICS

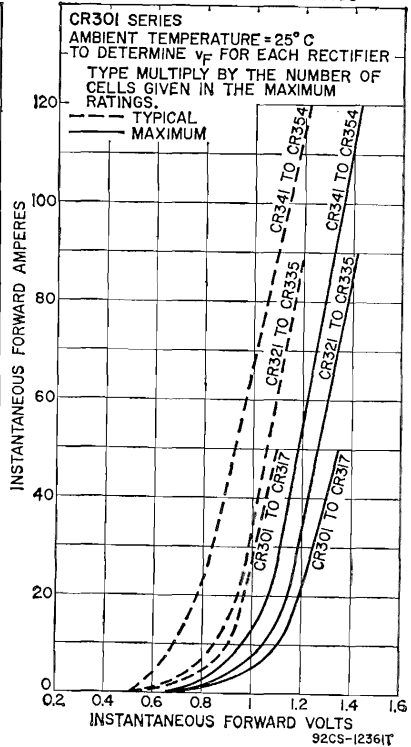

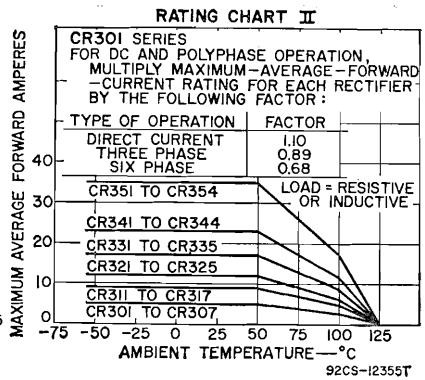
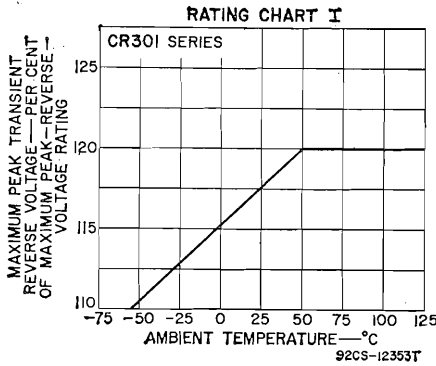

**TERMINAL-CONNECTION DIAGRAMS  
FOR DISCONTINUED TRANSISTORS**

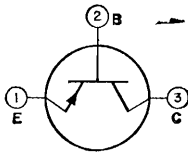

-1-

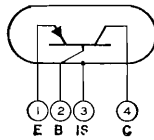

-2-

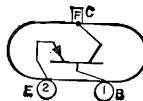

-3-

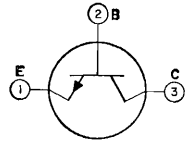

-4-

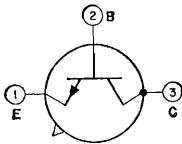

-5-

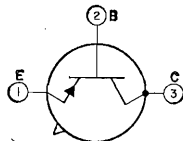

-6-

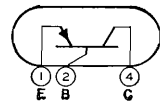

-7-

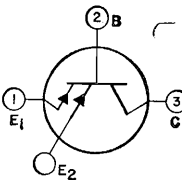

-8-

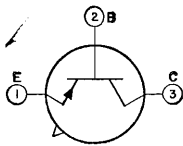

-9-

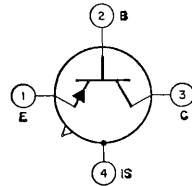

-10-



## LIST OF DISCONTINUED TRANSISTORS

(Shown for reference only; see page 81 for symbol identification.)

RCA Type	Terminal-Correction Diagram*	Out-line	MAXIMUM RATINGS				CHARACTERISTICS		Maximum Operating Temperature (C°)	Can be replaced by RCA type
			V <sub>CB</sub> (volts)	V <sub>EB</sub> (volts)	I <sub>O</sub> (amperes)	P <sub>T</sub> (watts)	Min. f <sub>FB</sub>	I <sub>CB</sub> (μA)		
2N105	1	—	-25	—	-0.015	0.035	55	-5	55	2N408
2N206	1	4	-30	—	-0.050	0.075	33	-10	85	2N408
2N247	2	7	-35	—	-0.010	0.080	60	-10	71	2N412
2N269	1	4	-25	-12	-0.100	0.120	24	-5	85	2N404
2N301	3	5	-40	-10	-3	11	70	-100	91	2N2869/2N301
2N301A	3	5	-60	-10	-3	11	70	-100	91	2N2870/2N301A
2N331	1	9	-30	-12	-0.200	0.200	50	-16	71	2N1638
2N356	4	—	20	20	0.5	0.100	30	5	85	2N647
2N357	4	—	20	20	0.5	0.100	30	5	85	2N647
2N358	4	—	20	20	0.5	0.100	30	5	85	2N647
2N373	2	7	-25	-0.5	-0.010	0.080	60	-8	71	2N1638
2N374	2	7	-25	-0.5	-0.010	0.080	60	-8	71	2N1631
2N456	3	26	-40	-20	-5	50	52	—	95	2N2869
2N457	3	26	-60	-20	-5	50	52	—	95	2N2869
2N497	5	6	60	8	—	4	12	10	200	—
2N544	2	7	-18	-1	-0.010	0.080	60	-4	71	2N1638
2N561	3	26	-80	-60	-10	50	75	—	100	2N2869
2N578	1	9	-20	-12	-0.400	0.120	10	-5	71	2N412
2N579	1	9	-20	-12	-0.400	0.120	20	-5	71	2N412
2N580	1	9	-20	-12	-0.400	0.120	30	-5	71	2N412
2N583	1	4	-18	-10	-0.100	0.120	20	-10	85	2N412
2N584	1	4	-25	-12	-0.100	0.120	40	-5	85	2N408
2N640	2	7	-34	-1	-0.010	0.080	50	-5	71	2N1637
2N641	2	7	-34	-1	-0.010	0.080	50	-7	71	2N1638
2N642	2	7	-34	-1	-0.010	0.080	50	-7	71	2N1639
2N643	1	9	-30	-2	-0.100	0.120	20	-10	71	2N705
2N644	1	9	-30	-2	-0.100	0.100	20	-10	71	2N705
2N645	1	9	-30	-2	-0.100	0.120	20	-10	71	2N705
2N656	5	6	60	8	—	4	30	10	200	—
2N696	5	6	60	5	-0.500	2	20	1	175	—
2N794	6	12	-13	-1	-0.100	0.150	30	-3	85	2N1300
2N795	6	12	-13	-4	-0.100	0.150	30	-3	85	2N1301
2N796	6	12	-13	-4	-0.100	0.150	50	-3	85	2N1683
2N1014	3	26	-100	-60	-10	50	75	—	100	2N2869
2N1213	6	6	-25	-1	-0.100	0.075	—	-3	85	—
2N1214	9	6	-25	-1	-0.100	0.075	—	-3	85	—
2N1215	9	6	-25	-1	-0.100	0.075	—	-3	85	—
2N1216	9	6	-25	-1	-0.100	0.075	—	-3	85	—
2N1425	2	7	-24	-0.5	-0.010	0.080	50	-12	71	2N1638
2N1426	2	7	-24	-0.5	-0.010	0.080	130	-12	71	2N1638
2N1450	1	9	-30	-1	-0.100	0.120	20	-10	85	2N217
2N1633	7	15	-34	-0.5	-0.010	0.080	75	-16	85	2N1638
2N1634	1	4	-34	-0.5	-0.010	0.080	75	-16	85	2N1638
2N1635	7	15	-34	-0.5	-0.010	0.080	75	-16	85	2N1638
2N1636	1	4	-34	-0.5	-0.010	0.080	75	-16	85	2N1638
2N2873	10	34	-35	-0.3	-0.010	0.115	40	12	100	—
3746	8	16	-34	-0.5	-0.20	0.080	—	-16	85	—

\* See page 322.

## TUNNEL DIODES

RCA Type	Electrical Characteristics (at 25°C Ambient Temperature)									
	Peak Forward Current (ma)	Max Valley Current (ma)	Min Peak-to-Valley Current Ratio	Peak Voltage (mv)	Min Valley Voltage (mv)	Forward Voltage (mv)	Max Capacitance* (pf)	Max Series Resistance (ohms)	Rise Time (psec) max.    typ.	
1N3128	4.75-5.25	0.6	8:1	40-80	280	445-530	15	3	5000	1000
1N3129	19-21	2.4	8:1	50-100	300	474-575	20	2.5	2000	300
1N3130	47.5-52.5	6	8:1	70-120	350	520-620	25	1.5	500	160
1N3847	4.5-5.5	0.75	6:1	—	—	430-590	25	3	—	900
1N3848	9-11	1.5	6:1	—	—	440-600	25	2.5	—	1800
1N3849	18-22	3	6:1	—	—	460-620	30	2	—	600
1N3850	45-55	7.5	6:1	—	—	530-640	40	1.5	—	350
1N3851	90-110	15	8:1	—	—	540-650	40	1	—	125
1N3852	4.75-5.25	0.6	8:1	50-90	330	490-560	15	3	—	1200
1N3853	9.5-10.5	1.2	8:1	55-95	350	510-580	15	2.5	—	600
1N3854	19-21	2.4	8:1	65-105	365	530-600	20	2	—	400
1N3855	47.5-52.5	6	8:1	80-130	380	550-620	25	1.5	—	200
1N3856	95-105	12	8:1	90-140	390	560-630	25	1	—	75
1N3857	4.75-5.25	0.6	8:1	50-90	330	490-560	8	3	—	600
1N3858	9.5-10.5	1.2	8:1	55-95	350	510-580	8	2.5	—	300
1N3859	19-21	2.4	8:1	65-105	365	530-600	—	—	—	150
1N3860	47.5-52.5	6	8:1	80-130	380	550-620	—	—	—	200
40058	47.5-52.5	—	12:1	—200	500	1050—	20**	3	500	333
40059	45-55	—	10:1	—200	450	1080—	40**	2.5	1000	667
40060	19-21	—	11:1	—180	500	1000—	15**	8	1000	600
40061	18-22	—	9:1	—180	450	900—	30**	5	2000	1250
40062	9.5-10.5	—	10:1	—180	500	1000—	10**	9	1250	1000
40063	9-11	—	9:1	—180	450	900—	25**	5	3000	2000
40064	4.75-5.25	—	10:1	—170	500	950—	8**	18	2000	1250
40065	4.5-5.5	—	8:1	—170	420	900—	20**	12	6000	3000
40076	180-220	—	15:1	240 typ	600 typ	—	25**	0.9	—	—
40077	0.9-1.1	0.15	6:1	60 typ	335 typ	—550	5**	4	—	—
40078	0.9-1.1	0.18	5:1	60 typ	330 typ	400-550	10**	6	—	—

\* Includes case capacitance of 0.8 pf.

\*\* Actual recorded capacitance readings are provided with this type. This value minus 0.8 pf determines the junction capacitance.

# TUNNEL DIODES

Maximum Ratings (at 25°C Ambient Temperature)							Material	Out- line	RCA Type
DC Current (ma)		Dissipation ‡ (mw)	Ambient Temperature (°C)		Lead Temperature (°C) (3 seconds maximum)				
Forward	Reverse		Operating	Range			Storage		
40	70	20	-65 to 150	-65 to 175	175	Ge	36	1N3128	
55	85	30	-65 to 150	-65 to 175	175	Ge	36	1N3129	
70	100	40	-65 to 150	-65 to 175	175	Ge	36	1N3130	
10	15	5	-35 to 100		175	Ge	36	1N3847	
18	25	15	-35 to 100		175	Ge	36	1N3848	
35	50	20	-35 to 100		175	Ge	36	1N3849	
85	125	50	-35 to 100		175	Ge	36	1N3850	
170	250	100	-35 to 100		175	Ge	36	1N3851	
10	15	5	-35 to 100		175	Ge	36	1N3852	
18	25	10	-35 to 100		175	Ge	36	1N3853	
35	50	20	-35 to 100		175	Ge	36	1N3854	
85	125	50	-35 to 100		175	Ge	36	1N3855	
170	250	100	-35 to 100		175	Ge	36	1N3856	
10	15	5	-35 to 100		175	Ge	36	1N3857	
18	25	10	-35 to 100		175	Ge	36	1N3858	
35	50	20	-35 to 100		175	Ge	36	1N3859	
85	125	50	-35 to 100		175	Ge	36	1N3860	
0.5ma/pft	250	—	-30 to 85		—	GaAs	38	40058	
0.5ma/pft	250	—	-30 to 85		—	GaAs	38	40059	
0.5ma/pft	100	—	-30 to 85		—	GaAs	38	40060	
0.5ma/pft	100	—	-30 to 85		—	GaAs	38	40061	
0.5ma/pft	50	—	-30 to 85		—	GaAs	38	40062	
0.5ma/pft	50	—	-30 to 85		—	GaAs	38	40063	
0.5ma/pft	25	—	-30 to 85		—	GaAs	38	40064	
0.5ma/pft	25	—	-30 to 85		—	GaAs	38	40065	
0.5ma/pft	400	—	-30 to 85		—	GaAs	39	40076	
1.6†	2.5	—	-30 to 85		—	Ge	38	40077	
1.6†	2.5	—	-30 to 85		—	Ge	38	40078	

† Above 25°C, derate linearly to valley current at 75°C.

‡ Above 25°C, derate linearly to 0 mw at 100°C.

## TUNNEL RECTIFIERS

RCA Type	Material	Out-line	Electrical Characteristics (at 25°C Ambient Temperature)				
			Peak Current (ma)	Min Forward Voltage at 1 ma (mv)	Max Reverse Voltage at 10 ma (mv)	Max Reverse Voltage at 30 ma (mv)	Max Capacitance (pf)
1N3861	Ge	37	0.1-1	400	170	—	6*
1N3862	Ge	37	0.1-1	420	150	300	4*
1N3863	Ge	37	0.1-0.5	435	150	300	4*
40054	GaAs	38	1	950	300	—	6**
40055	GaAs	38	0.5	950	350	—	6**
40056	GaAs	38	1	950	225	—	6**
40057	GaAs	38	0.5	950	275	—	6**

\* Includes case capacitance of 0.4 pf.

\*\* Includes case capacitance of 0.8 pf.

## HIGH-CURRENT TUNNEL DIODES

RCA Type	Material	Out-line	Electrical Characteristics (at 25°C Ambient Temperature)								
			Peak Current (ma)	Min Peak-to-Valley Current Ratio	Max Peak Voltage (mv)	Min Valley Voltage (mv)	Min Forward Voltage (mv)	Typ Capacitance (ufd)	Typ Series Resistance (ohms)	Typ Rise Time (nsec)	Typ Junction Resistance (ohms)
40066	Ge	2	0.9-1.1	8:1	125	300	490	0.002	0.055	1	0.12
40067	Ge	2	4.5-5.5	8:1	130	300	490	0.016	0.014	1.5	0.024
40068	Ge	3	9.0-11.0	8:1	130	300	490	0.045	0.007	2	0.012
40069	Ge	3	18-22	8:1	130	300	490	0.090	0.0035	2	0.006
40070	Ge	40	90-110	8:1	130	300	430	0.5	0.0006	2	0.0012
40079	GaAs	40	180-220	10:1	180	550	—	1.25	0.0002	4	0.001

## TUNNEL RECTIFIERS

Maximum Ratings (at 25°C Ambient Temperature)					
Forward	DC Current (ma) Reverse	Dissipation ‡ (mw)	Ambient-Temperature (°C) Range Operating and Storage	Lead Temperature (3 seconds maximum)	RCA Type
10	30	10	-35 to 100	175	1N3861
10	30	10	-35 to 100	175	1N3862
10	30	10	-35 to 100	175	1N3863
0.5ma/pf	15	—	-35 to 85	—	40054
0.5ma/pf	15	—	-35 to 85	—	40055
0.5ma/pf	15	—	-35 to 85	—	40056
0.5ma/pf	15	—	-35 to 85	—	40057

‡ Above 25°C, derate linearly to 0 mw at 100°C.

## HIGH-CURRENT TUNNEL DIODES

Maximum Ratings (at 25°C Ambient Temperature)		
Dissipation ‡ (watts)	Ambient-Temperature (°C) Range Operating and Storage	RCA Type
0.45	-55 to 85	40066
1.7	-55 to 85	40067
3.5	-55 to 85	40068
7.0	-55 to 85	40069
30.0	-55 to 85	40070
50.0	-55 to 85	40079

‡ Above 25°C, derate linearly to 0 watt at 85°C.

## VARACTOR DIODES

### (V1000 to V7000 Series)

Silicon and gallium arsenide types used in a wide variety of industrial circuits such as frequency multipliers, reactance tuners, rf limiters, parametric amplifiers, rf switches, and rf modulators. These types offer cutoff frequencies to 300 gigacycles and breakdown voltages to 200 volts.

### 6-VOLT GALLIUM ARSENIDE PARAMETRIC AMPLIFIER TYPES

Minimum Breakdown Voltage at reverse $\mu\text{a} = 10 \dots$	6	volts
Maximum Dissipation at case temperature = $25^\circ\text{C} \dots$	150*	mw
Storage and Operating Temperature Range $\dots\dots\dots$	$-269$ to $150$	$^\circ\text{C}$
Case Inductance (typical) $\dots\dots\dots$	0.35	nh
Case Capacitance (typical) $\dots\dots\dots$	0.35	pf

#### Pill Package (outline 41)

Cutoff Frequency** (Gc)	Junction Capacitance†—pf							
	0.15-0.3	0.15-0.25	0.2-0.4	0.3-0.6	0.15-0.2	0.2-0.3	0.3-0.4	0.4-0.6
125	V1000	—	V1001	V1002	V1003	V1004	V1005	V1006
150	V1010	—	V1011	V1012	V1013	V1014	V1015	V1016
175	V1020	—	V1021	V1022	V1023	V1024	V1025	V1026
200	V1030	—	V1031	—	V1033	V1034	V1035	—
225	V1040	—	—	—	V1043	V1044	—	—
250	V1050	—	—	—	V1053	V1054	—	—
300	—	V1060	—	—	—	—	—	—

#### Prong Package (outline 42)

Cutoff Frequency** (Gc)	Junction Capacitance†—pf							
	0.15-0.3	0.15-0.25	0.2-0.4	0.3-0.6	0.15-0.2	0.2-0.3	0.3-0.4	0.4-0.6
125	V2000	—	V2001	V2002	V2003	V2004	V2005	V2006
150	V2010	—	V2011	V2012	V2013	V2014	V2015	V2016
175	V2020	—	V2021	V2022	V2023	V2024	V2025	V2026
200	V2030	—	V2031	—	V2033	V2034	V2035	—
225	V2040	—	—	—	V2043	V2044	—	—
250	V2050	—	—	—	V2053	V2054	—	—
300	—	V2060	—	—	—	—	—	—

\* Derate linearly to zero at maximum rated temperature.

\*\* Calculated from  $Q$  measured at reverse volts =  $-6$  at 10 gigacycles. Cutoff frequency =  $\frac{1}{2\pi R_s C_j} = Qf$  where  $R_s$  is the series resistance,  $C_j$  is the junction capacitance, and  $Q$  is the quality factor at frequency  $f$ .

† Measured at reverse volts =  $-6$ , frequency = 1 Mc. Junction capacitance =  $C_0 \left(1 - \frac{V}{\phi}\right)^{-n}$  where  $C_0$  is the capacitance at zero bias,  $V$  is the bias voltage,  $\phi$  is approximately 1.1 volts, and  $n$  is typically 0.4.

**30-VOLT GALLIUM ARSENIDE POWER VARACTORS  
(Outline 42)**

Minimum Breakdown Voltage at reverse current = 10 $\mu$ a .....	30	volts
Maximum Dissipation* at case temperature = 25°C:		
For types having $C_j = 0.2$ to $0.4$ pf .....	300	mw
For types having $C_j = 0.4$ to $0.8$ pf .....	400	mw
For types having $C_j = 0.8$ to $1.2$ pf .....	500	mw
Storage and Operating Temperature Range .....	-196 to 150	°C
Case Inductance (typical) .....	0.35	nh
Case Capacitance (typical) .....	0.35	pf

Cutoff Frequency** (Gc)		Junction Capacitance†—pf						
Min (V <sub>R</sub> = -6v)	Typ (V <sub>R</sub> = -30v)	0.2-0.8	0.4-1.2	0.4-1.1	0.2-0.4	0.4-0.8	0.8-1.2	0.8-1.1
20	35	V3000	V3001	—	V3002	V3003	V3004	—
40	65	V3010	V3011	—	V3012	V3013	V3014	—
60	100	V3020	V3021	—	V3022	V3023	V3024	—
80	135	V3030	—	V3031	V3032	V3033	—	V3034
100	170	V3040	—	—	V3042	V3043	—	—
120	200	V3050	—	—	V3052	V3053	—	—

**45-VOLT GALLIUM ARSENIDE POWER VARACTORS  
(Outline 42)**

Minimum Breakdown Voltage at reverse current = 10 $\mu$ a .....	45	volts
Maximum Dissipation* at case temperature = 25°C:		
For types having $C_j = 0.2$ to $0.4$ pf .....	300	mw
For types having $C_j = 0.4$ to $0.8$ pf .....	400	mw
For types having $C_j = 0.8$ to $1.2$ pf .....	600	mw
Storage and Operating Temperature Range .....	-196 to 150	°C
Case Inductance (typical) .....	0.35	nh
Case Capacitance (typical) .....	0.35	pf

Cutoff Frequency** (Gc)		Junction Capacitance†—pf						
Min (V <sub>R</sub> = -6v)	Typ (V <sub>R</sub> = -45v)	0.2-0.8	0.4-1.2	0.4-1.1	0.2-0.4	0.4-0.8	0.8-1.2	0.8-1.1
20	40	V3100	V3101	—	V3102	V3103	V3104	—
40	75	V3110	V3111	—	V3112	V3113	V3114	—
60	115	V3120	V3121	—	V3122	V3123	V3124	—
80	155	V3130	—	V3131	V3132	V3133	—	V3134
100	190	V3140	—	—	V3142	V3143	—	—

\* Derate linearly to zero at maximum rated temperature.

\*\* Calculated from Q measured at reverse volts = -6 at 10 gigacycles. Cutoff frequency =  $\frac{1}{2\pi R_s C_j} = Qf$  where  $R_s$  is the series resistance,  $C_j$  is the junction capacitance, and Q is the quality factor at frequency f.

† Measured at reverse volts = -6, frequency = 1 Mc. Junction capacitance =  $C_0 \left(1 - \frac{V}{\phi}\right)^{-n}$  where  $C_0$  is the capacitance at zero bias, V is the bias voltage,  $\phi$  is approximately 1 volt, and n is typically 0.35.

### 60-VOLT SILICON MICROWAVE POWER VARACTORS (Outline 44)

Minimum Breakdown Voltage at reverse  $\mu a = 10 \dots 60$  volts  
 Maximum Dissipation at case temperature = 25°C .. 2.5\* watts  
 Storage and Operating Temperature Range ..... -65 to 175 °C  
 Case Capacitance (typical) ..... 0.6 pf

Cutoff Frequency** (Gc)	Junction Capacitance†—pf		
	0.6-1.2	1.2-1.8	1.8-2.5
48	V7000	V7001	V7102
60	V7010	V7011	V7012

### 75-VOLT SILICON MICROWAVE POWER VARACTORS (Outline 44)

Minimum Breakdown Voltage at reverse  $\mu a = 10 \dots 75$  volts  
 Maximum Dissipation at case temperature = 25°C .. 2.5\* watts  
 Storage and Operating Temperature Range ..... -65 to 175 °C  
 Case Capacitance (typical) ..... 0.6 pf

Cutoff Frequency** (Gc)	Junction Capacitance†—pf		
	0.6-1.2	1.2-1.8	1.8-2.5
35	V7100	V7101	V7102
50	V7110	V7111	V7112

### 90-VOLT SILICON MICROWAVE POWER VARACTORS (Outline 44)

Minimum Breakdown Voltage at reverse  $\mu a = 10 \dots 90$  volts  
 Maximum Dissipation at case temperature = 25°C .. 2.5\* watts  
 Storage and Operating Temperature Range ..... -65 to 175 °C  
 Case Capacitance (typical) ..... 0.6 pf

Cutoff Frequency** (Gc)	Junction Capacitance†—pf		
	0.6-1.2	1.2-1.8	1.8-2.5
30	V7200	V7201	V7202

\* Derate linearly to zero at maximum rated temperature.

\*\* Cutoff frequency =  $\frac{1}{2\pi R_s C_j}$  where  $R_s$  is the series resistance at reverse volts = -6 at 2 gigacycles and  $C_j$  is the junction capacitance at the same voltage.

† Measured at reverse volts = -6, frequency = 1 Mc. Junction capacitance =  $C_0 \left(1 - \frac{V}{\phi}\right)^{-n}$  where  $C_0$  is the capacitance at zero bias,  $V$  is the bias voltage,  $\phi$  is approximately 0.6 volt, and  $n$  is typically 0.35.



**125- TO 200-VOLT SILICON UHF POWER VARACTORS  
(Outline 44)**

Maximum Dissipation at case temperature = 25°C .. 7.5\* watts  
 Storage and Operating Temperature Range ..... -65 to 175 °C  
 Case Capacitance (typical) ..... 0.6 pf

**125-VOLT TYPES\*\***

Cutoff Frequency† (Gc)	Junction Capacitance‡—pf						
	1-3	2-5	2-4	1-2	2-3	3-5	3-4
30	V6000	V6001	—	V6002	V6003	V6004	—
50	V6010	V6011	—	V6012	V6013	V6014	—
70	V6020	V6021	—	V6022	V6023	V6024	—

**150-VOLT TYPES\*\***

30	V6100	—	V6101	V6102	V6103	—	V6104
50	V6110	—	V6111	V6112	V6113	—	V6114
70	V6120	—	V6121	V6122	V6123	—	V6124

**175-VOLT TYPES\*\***

30	V6200	—	V6201	V6202	V6203	—	V6204
50	V6210	—	V6211	V6212	V6213	—	V6214
70	V6220	—	V6221	V6222	V6223	—	V6224

**200-VOLT TYPES\*\***

30	V6300	—	V6301	V6302	V6303	—	V6304
50	V6310	—	V6311	V6312	V6313	—	V6314
70	V6320	—	V6321	V6322	V6323	—	V6324

**125- TO 200-VOLT SILICON VHF POWER VARACTORS  
(Outline 43)**

Maximum Dissipation at case temperature = 25°C .. 12\* watts  
 Storage and Operating Temperature Range ..... -65 to 175 °C  
 Case Capacitance (typical) ..... 1 pf

Cutoff Frequency† (Gc)	Breakdown Voltage** (volts)	Junction Capacitance‡—pf		
		4-8	4-9	4-10
20	125	—	—	V5000
20	150	—	V5100	—
20	175	V5200	—	—
20	200	V5300	—	—

\* Derate linearly to zero at maximum rated temperature.

\*\* Minimum breakdown voltage measured at reverse current = 10 μa.

† Cutoff frequency =  $\frac{1}{2\pi R_s C_j}$  where  $R_s$  is the series resistance at the specified minimum breakdown voltage (measured at 2 gigacycles) and  $C_j$  is the junction capacitance measured at 1 Mc at the same voltage.

‡ Measured at minimum breakdown voltage, frequency = 1 Mc. Junction capacitance =  $C_0 \left(1 - \frac{V}{\phi}\right)^{-n}$  where  $C_0$  is the capacitance at zero bias,  $V$  is the bias voltage,  $\phi$  is approximately 0.6 volt, and  $n$  is typically 0.4.

# Outlines

Dimensions in inches

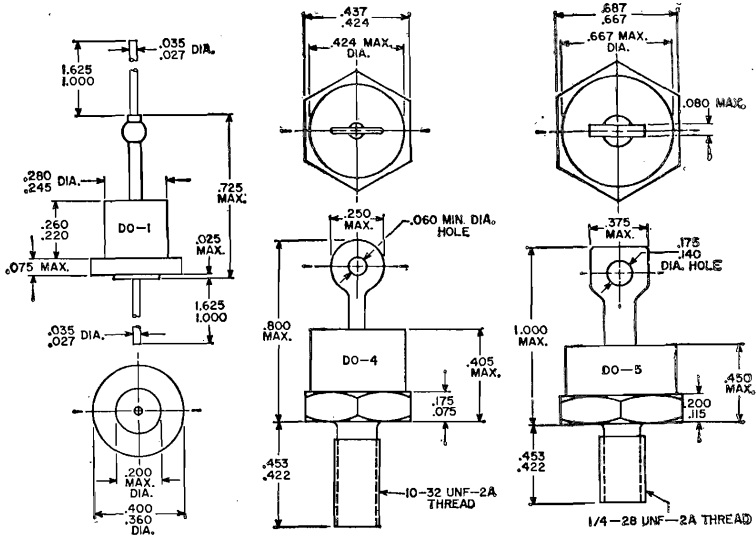

- 1 -

- 2 -

- 3 -

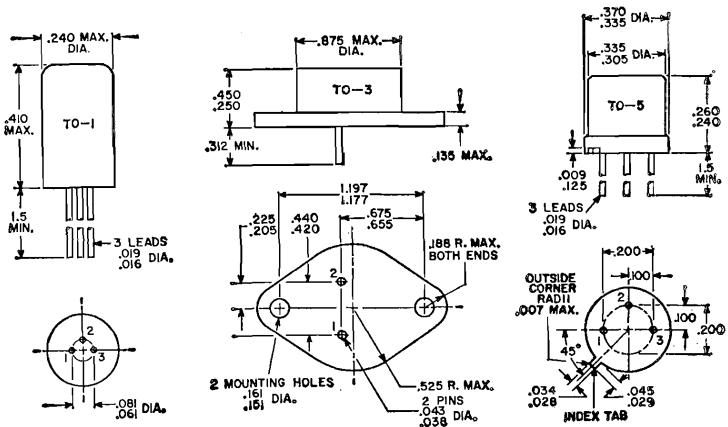

- 4 -

- 5 -

- 6 -

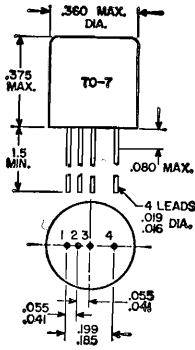

- 7 -

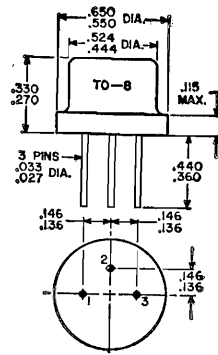

- 8 -

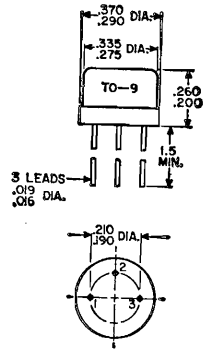

- 9 -

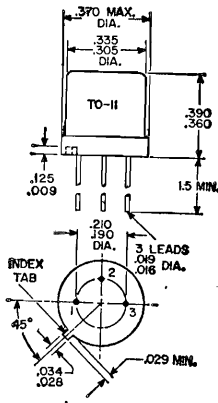

- 10 -

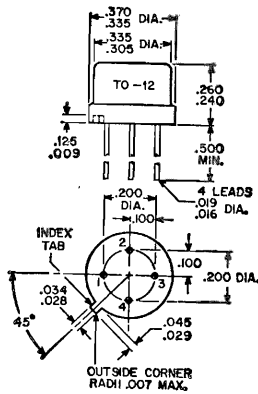

- 11 -

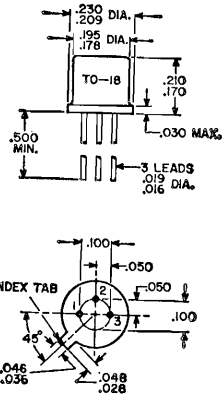

- 12 -

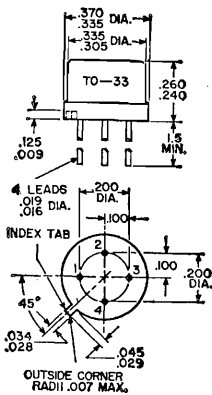

- 13 -

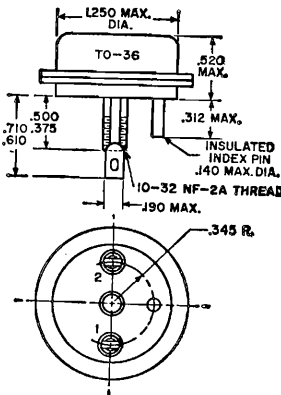

- 14 -

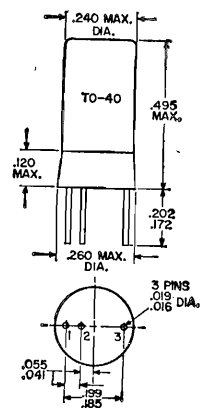

- 15 -

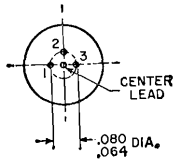
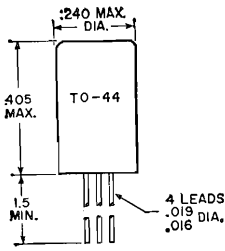

- 16 -

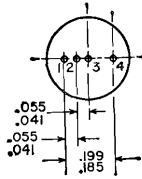
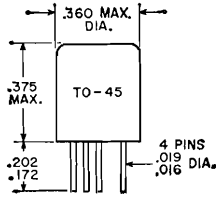

- 17 -

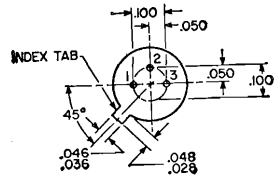
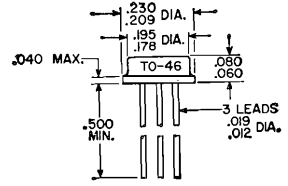

- 18 -

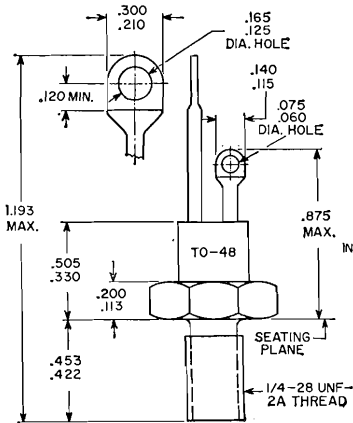
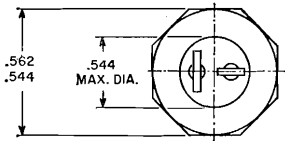

- 19 -

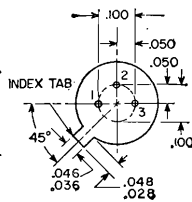
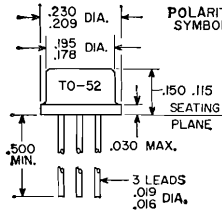

- 20 -

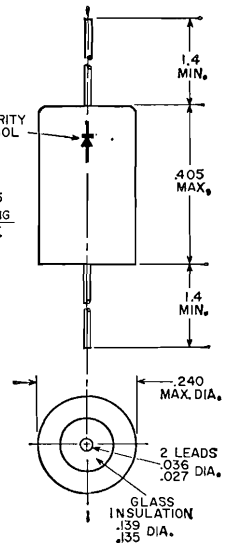

- 21 -

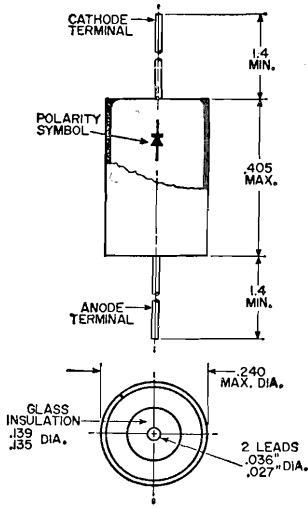

- 22 -

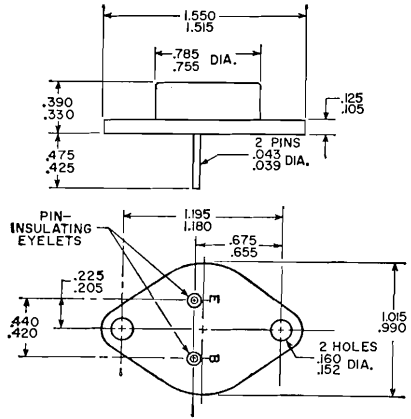

- 23 -

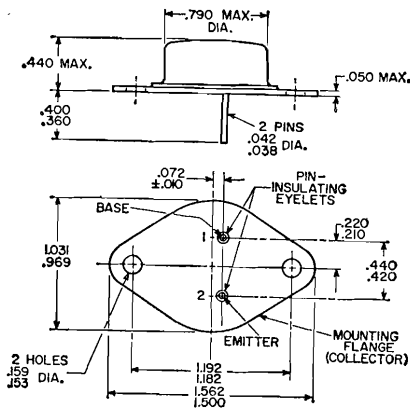

- 24 -

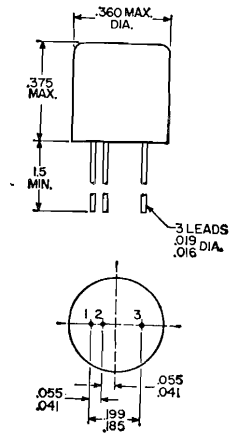

- 25 -

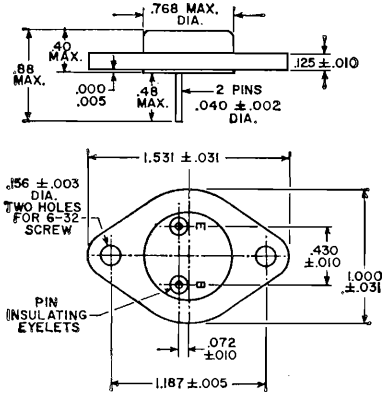

- 26 -

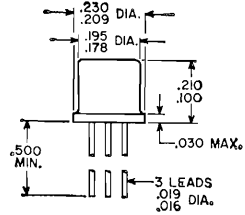

- 27 -

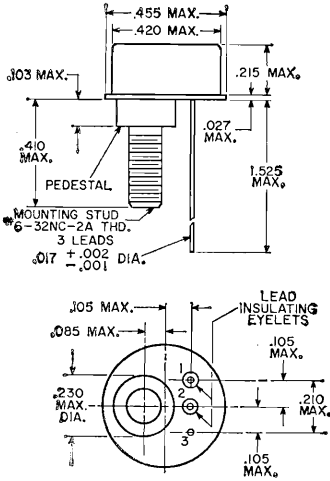

- 28 -

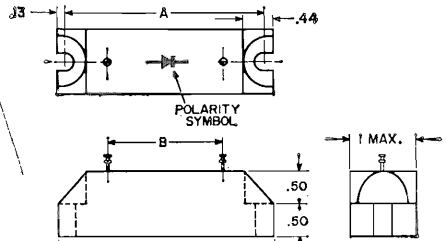

TYPE	DIMENSIONS—INCHES		
	A	B	C
CR101	2-3/8	1-1/8	2-1/8
CR102	2-3/8	1-1/8	2-1/8
CR103	2-3/8	1-1/8	2-1/8
CR104	3-1/4	1-3/4	3
CR105	3-1/4	1-3/4	3
CR106	4-1/2	3-1/4	4-1/4
CR107	4-1/2	3-1/4	4-1/4
CR108	4-1/2	3-1/4	4-1/4
CR109	5-1/2	4	5-1/4
CR110	5-1/2	4	5-1/4

- 29 -

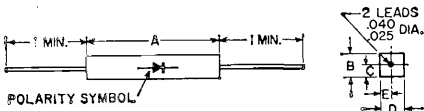

TYPE	DIMENSIONS—INCHES				
	A	B	C	D	E
CR201	2	3/8	3/16	3/8	3/16
CR203	3-1/2	3/8	3/16	3/8	3/16
CR204	4-1/2	3/8	3/16	3/8	3/16
CR206	3-1/2	3/8	3/16	3/4	3/8
CR208	3-1/2	3/8	3/16	3/4	3/8
CR210	4-1/2	3/8	3/16	3/4	3/8
CR212	4-1/2	3/8	3/16	3/4	3/8

- 30 -

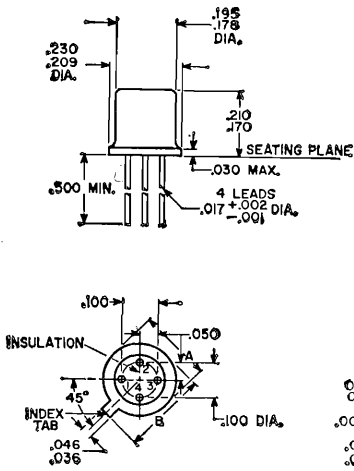

- 31 -

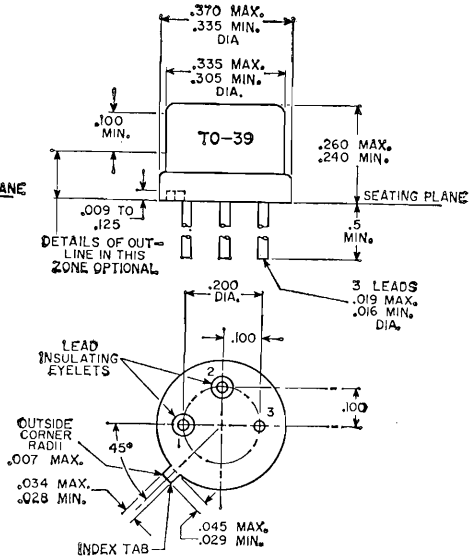

- 32 -

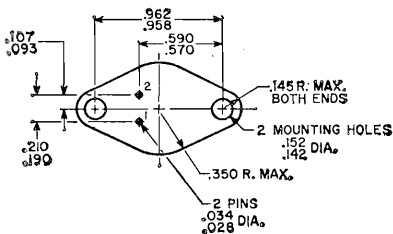
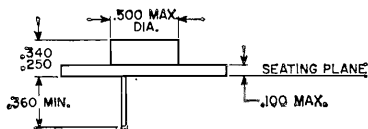

- 33 -

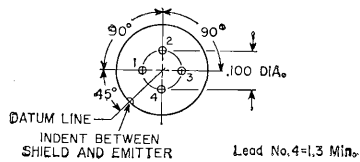
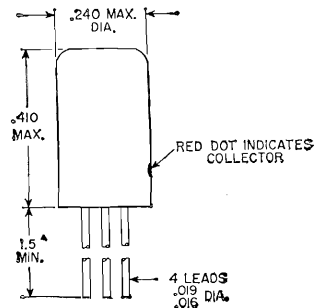

- 34 -

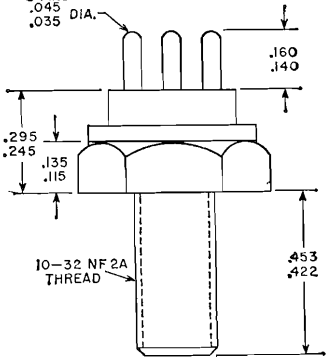
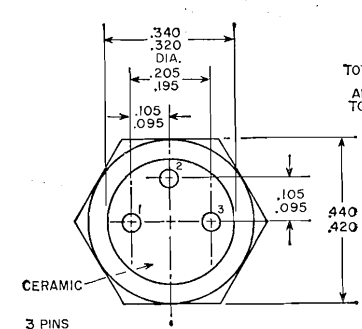

- 35 -

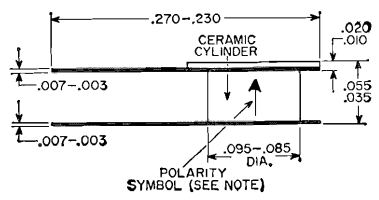
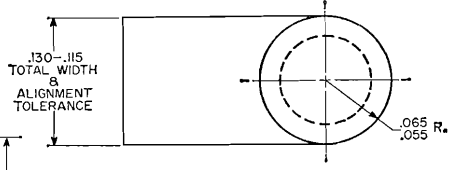

- 36 -

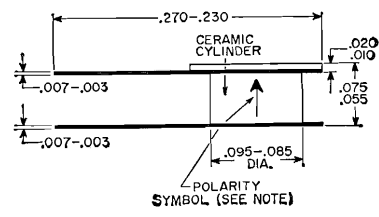
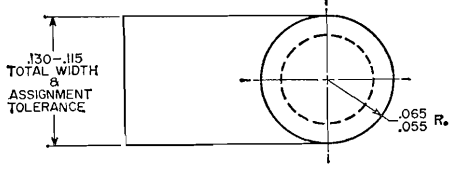

- 37 -

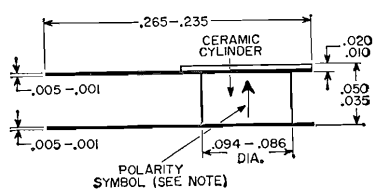
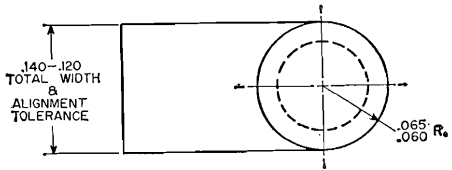

- 38 -

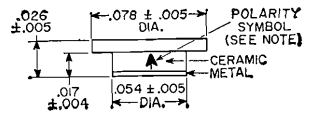

Note: Arrow shows the direction of forward current flow as indicated by dc ammeter.

- 39 -



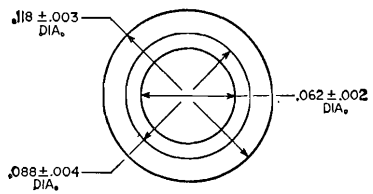
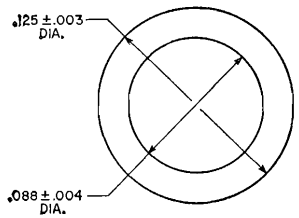
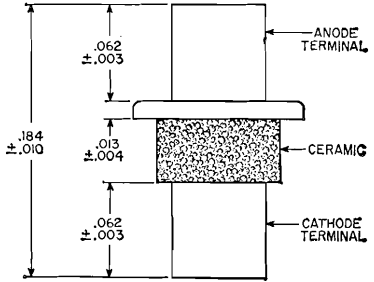
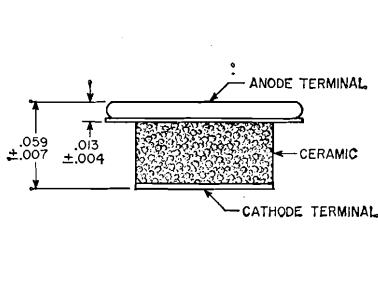
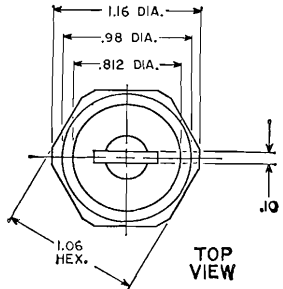
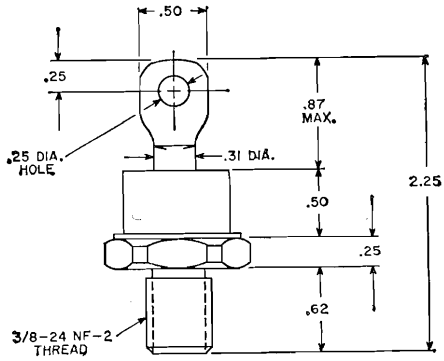

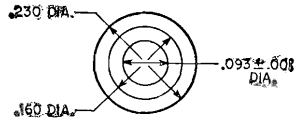
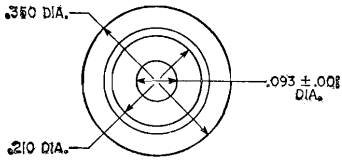
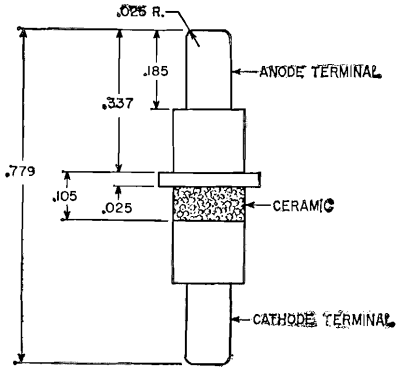
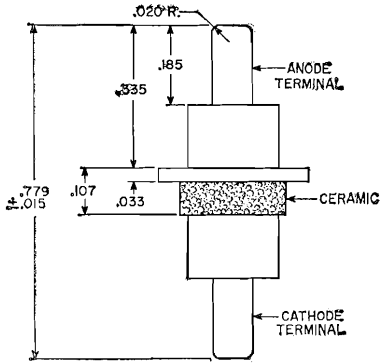

- 43 -

- 44 -

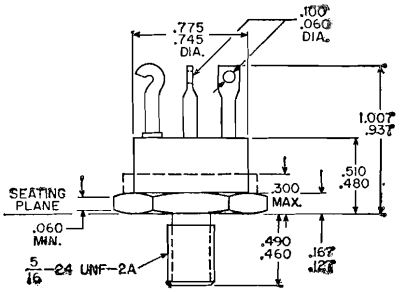
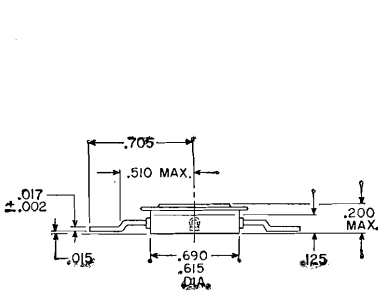
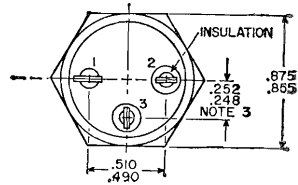
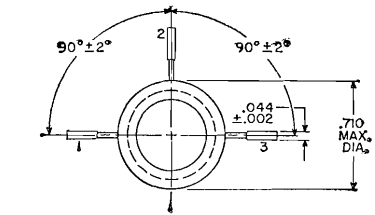

- 45 -

- 46 -

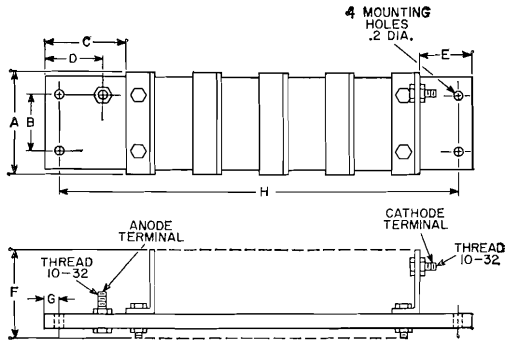

- 47 -

DIMENSIONS—INCHES

RCA types	A	B	C	D	E	F	G
CR301 through CR307	2-1/4	1-5/8	2-1/32	1-5/16	15/16	2	7/16
CR311 through CR317	2-1/4	1-5/8	2-1/32	1-5/16	15/16	2	7/16
CR321 through CR325	3	1-7/8	2-3/4	1-3/4	1-3/8	3-3/8	9/16
CR331 through CR335	3	1-7/8	2-3/4	1-3/4	1-3/8	3-3/8	9/16
CR341 through CR344	5-1/2	4	3	1-29/32	1-17/32	5-3/8	5/8
CR351 through CR354	5-1/2	4	3	1-29/32	1-17/32	5-3/8	5/8

"H" DIMENSION FOR EACH TYPE IN CR301 FAMILY  
(inches)

CR301	5-1/4	CR312	7	CR323	11-7/8	CR341	7-11/16
CR302	7	CR313	8-3/4	CR324	14-1/4	CR342	10-1/4
CR303	8-3/4	CR314	10-1/2	CR325	16-5/8	CR343	12-13/16
CR304	10-1/2	CR315	12-1/4	CR331	7-1/8	CR344	15-3/8
CR305	12-1/4	CR316	14	CR332	9-1/2	CR351	7-11/16
CR306	14	CR317	15-3/4	CR333	11-7/8	CR352	10-1/4
CR307	15-3/4	CR321	7-1/8	CR334	14-1/4	CR353	12-13/16
CR311	5-1/4	CR322	9-1/2	CR335	16-5/8	CR354	15-3/8

# Circuits

**T**HE CIRCUITS in this section illustrate some of the more important applications of RCA semiconductor devices; they are not necessarily examples of commercial practice. These circuits have been conservatively designed and are capable of excellent performance. Electrical specifications are given for circuit components to assist those interested in home construction. Layouts and mechanical details are omitted because they vary widely with the requirements of individual set builders and with the sizes and shapes of the components employed.

Performance of these circuits depends as much on the quality of the components selected and the care employed in layout and construction as on the circuits themselves. Good signal reproduction from receivers and amplifiers requires the use of good-quality speakers, transformers, chokes and input sources (microphones, phonograph pickups, etc.).

Coils for the receiver circuits may be purchased at local parts dealers by specifying the characteristics required: for rf coils, the circuit position (antenna or interstage), tuning

range desired, and tuning capacitances employed; for if coils or transformers, the intermediate frequency, circuit position (1st if, 2nd if, etc.), and, in some cases, the associated transistor types; for oscillator coils, the receiver tuning range, intermediate frequency, type of converter transistor, and type of winding (tapped or transformer-coupled).

The voltage ratings specified for capacitors are the minimum dc working voltages required. Paper, mica, or ceramic capacitors having higher voltage ratings than those specified may be used except insofar as the physical sizes of such capacitors may affect equipment layout. However, if electrolytic capacitors having substantially higher voltage ratings than those specified are used, they may not "form" completely at the operating voltage, with the result that the effective capacitances of such units may be below their rated value. The wattage ratings specified for resistors assume methods of construction that provide adequate ventilation; compact installations having poor ventilation may require resistors of higher wattage ratings.

## LIST OF CIRCUITS

	<i>Page</i>
11-1 3-Volt Portable Radio Receiver .....	344
11-2 6-Volt Portable Radio Receiver .....	345
11-3 6-Volt Automobile Radio Receiver .....	346
11-4 12-Volt Automobile Radio Receiver .....	347
11-5 AM/FM Automobile Radio Receiver .....	348
11-6 Three-Band Radio Receiver .....	350
11-7 "Front End" for Radio Receiver .....	351
11-8 Preampifier for Phono/FM Pickup .....	352
11-9 Earphone Amplifier .....	353
11-10 Phonograph Amplifier .....	353
11-11 25-Watt, High-Quality Audio Power Amplifier .....	354
11-12 FM Stereo Multiplex Adapter .....	355
11-13 Stereo Amplifier (3-watt output per channel) .....	356
11-14 Stereo Amplifier (15-watt output per channel) .....	357

11-15	Power Supply for Amateur Transmitter .....	358
11-16	27-Mc Citizens-Band Transceiver .....	359
11-17	27-Mc, 5-Watt Citizens-Band Transmitter .....	360
11-18	Video Amplifier .....	361
11-19	70-Mc Power Amplifier .....	361
11-20	"Front End" for 450-Mc Superheterodyne Receiver .....	362
11-21	30-Mc IF Amplifier .....	363
11-22	Servo Amplifier .....	364
11-23	100-Kc Power Oscillator .....	364
11-24	27-Mc Crystal Oscillator .....	365
11-25	70-Mc Power Oscillator .....	365
11-26	250-Mc Oscillator .....	366
11-27	DC-to-DC Converter .....	366
11-28	Voltage Regulator, Shunt Type (Regulation 1.5%) .....	367
11-29	Voltage Regulator, Series Type (Regulation 2%) .....	367
11-30	Voltage Regulator, Shunt Type (Regulation 0.5%) .....	368
11-31	Voltage Regulator, Series Type (with adjustable output) .....	368
11-32	Astable Multivibrator .....	369
11-33	Monostable Multivibrator .....	369
11-34	Bistable Multivibrator .....	370
11-35	6-Volt Ignition System .....	371
11-36	12-Volt Ignition System .....	371
11-37	Voltage-Sensitive Switch (used with normally open relay) ....	372
11-38	Voltage-Sensitive Switch (used with normally closed relay) ..	372
11-39	Shift Register .....	373
11-40	Electronic Thermostat .....	374
11-41	Electronic Keyer .....	375
11-42	Grid-Dip Meter .....	376
11-43	Light Flasher .....	376
11-44	Light-Dimmer Control Using Silicon Controlled Rectifier ....	377
11-45	Code-Practice Oscillator .....	377
11-46	Photo-Relay .....	377

## MANUFACTURERS OF COILS AND ASSOCIATED MATERIALS

### REFERRED TO IN PARTS LISTS

#### Arnold Magnetics

6050 West Jefferson Blvd.  
Los Angeles, Calif.

#### Better Coil and Transformer Inc.

Goodland, Ind.

#### Columbus Process Co.

Columbus, Ind.

#### General Ceramic Corp.

Crows Mill Road  
Keasby, N.J.

#### General Instrument Co.

Automatic Winding Division  
65 Gouverneur Street  
Newark, N.J.

#### P. R. Mallory and Co., Inc.

3029 East Washington Street  
Indianapolis, Ind.

#### Microtran Co., Inc.

145 East Mineola Avenue  
Valley Stream, N.Y.

#### Mid-West Coil and Transformer Co.

1642 N. Halstead  
Chicago, Ill.

#### J. W. Miller Co.

5917 South Main Street  
Los Angeles, Calif.

#### Radio Condenser Corp.

Davis and Copewood Street  
Camden, N.J.

#### Stancor Electronics, Inc.

3501 West Addison Street  
Chicago, Ill.

#### Thompson-Ramo-Wooldridge, Inc.

Electronic Components Division  
666 Garland Place  
Des Plaines, Ill.

#### Thordarson

7th and Belmont  
Mt. Carmel, Ill.

11-1

## 3-VOLT PORTABLE RADIO RECEIVER

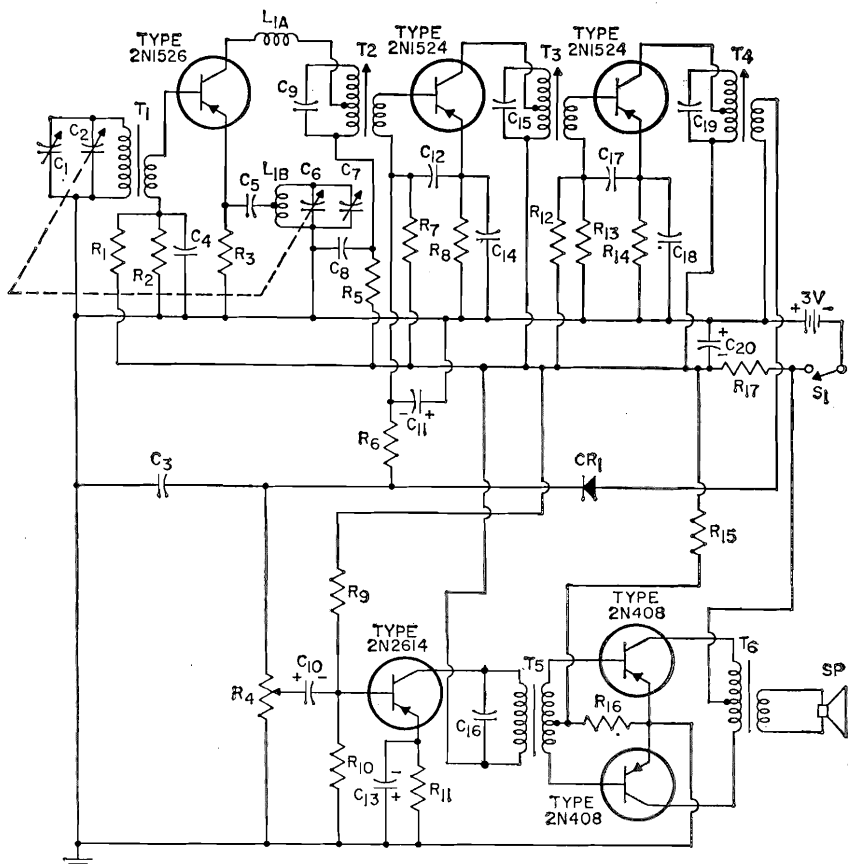

$C_1$  = trimmer, 3 to 15 pf  
 $C_2, C_6$  = ganged tuning capacitor,  $C_2 = 9.5$  to 141 pf,  $C_6 = 7.2$  to 109 pf  
 $C_3, C_4 = 0.02 \mu\text{f}$ , ceramic  
 $C_5 = 0.005 \mu\text{f}$ , ceramic  
 $C_7$  = trimmer, 3 to 20 pf  
 $C_8, C_{12}, C_{17}, C_{18} = 0.05 \mu\text{f}$ , ceramic  
 $C_9 = 128$  pf (part of  $T_2$ )  
 $C_{10} = 2 \mu\text{f}$ , electrolytic, 3 v.  
 $C_{11} = 10 \mu\text{f}$ , electrolytic, 3 v.  
 $C_{13}, C_{20} = 100 \mu\text{f}$ , electrolytic, 3 v.  
 $C_{15} = 125$  pf (part of  $T_3$ )  
 $C_{16} = 0.005 \mu\text{f}$ , ceramic  
 $C_{19} = 125$  pf (part of  $T_4$ )  
 $CR_1 = 1N295$   
 $L_1$  = oscillator coil; wound from No. 3/44 Litz wire on coil form suitable for a No. 10-32 slug;  $L_{1A}$ , 19 turns;  $L_{1B}$ , 155 turns, tapped at 8 turns from ground end, tunes with 100 pf at 990 kilocycles  
 $R_1, R_8 = 10000$  ohms, 0.5 watt  
 $R_2 = 3900$  ohms, 0.5 watt

$R_3, R_{15} = 1500$  ohms, 0.5 watt  
 $R_4$  = volume-control potentiometer, 5000 ohms, audio taper (part of assembly with ON-OFF switch  $S_1$ )  
 $R_5 = 470$  ohms, 0.5 watt  
 $R_6 = 6800$  ohms, 0.5 watt  
 $R_7 = 39000$  ohms, 0.5 watt  
 $R_8 = 330$  ohms, 0.5 watt  
 $R_{10} = 2700$  ohms, 0.5 watt  
 $R_{11} = 270$  ohms, 0.5 watt  
 $R_{12} = 10000$  ohms, 0.5 watt  
 $R_{13} = 2200$  ohms, 0.5 watt  
 $R_{14} = 240$  ohms, 0.5 watt  
 $R_{16} = 100$  ohms, 0.5 watt  
 $R_{17} = 47$  ohms, 0.5 watt  
 $S_1$  = ON-OFF switch (part of assembly with potentiometer  $R_4$ )  
 $SP$  = speaker; voice-coil impedance, 12 to 15 ohms  
 $T_1$  = antenna transformer; primary, 110 turns of No. 10/41 Litz wire wound on a  $\frac{3}{4}$ "-by- $\frac{1}{8}$ "-by-4" ferrite rod (pitch, 50 turns per inch); secondary, 6 turns of No. 10/41 Litz

wire wound at the start of the primary;  $Q = 100$  with transformer mounted on chassis; transformer should tune with 135 pf at 535 kilocycles  
 $T_2 = 1$ st if transformer; Thompson-Ramo-Wooldridge EO-13550, or equiv.  
 $T_3 = 2$ nd if transformer; secondary Thompson-Ramo-Wooldridge EO-13551, or equiv.  
 $T_4 = 3$ rd if transformer; secondary Thompson-Ramo-Wooldridge EO-13552, or equiv.  
 $T_5 =$  driver transformer; primary impedance, 10000 ohms; secondary impedance, 2000 ohms, center-tapped  
 $T_6 =$  output transformer; primary impedance, 100 ohms, center-tapped; secondary impedance, 15 ohms (to match voice-coil impedance of 12 to 15 ohms)

## 11-2

## 6-VOLT PORTABLE RADIO RECEIVER

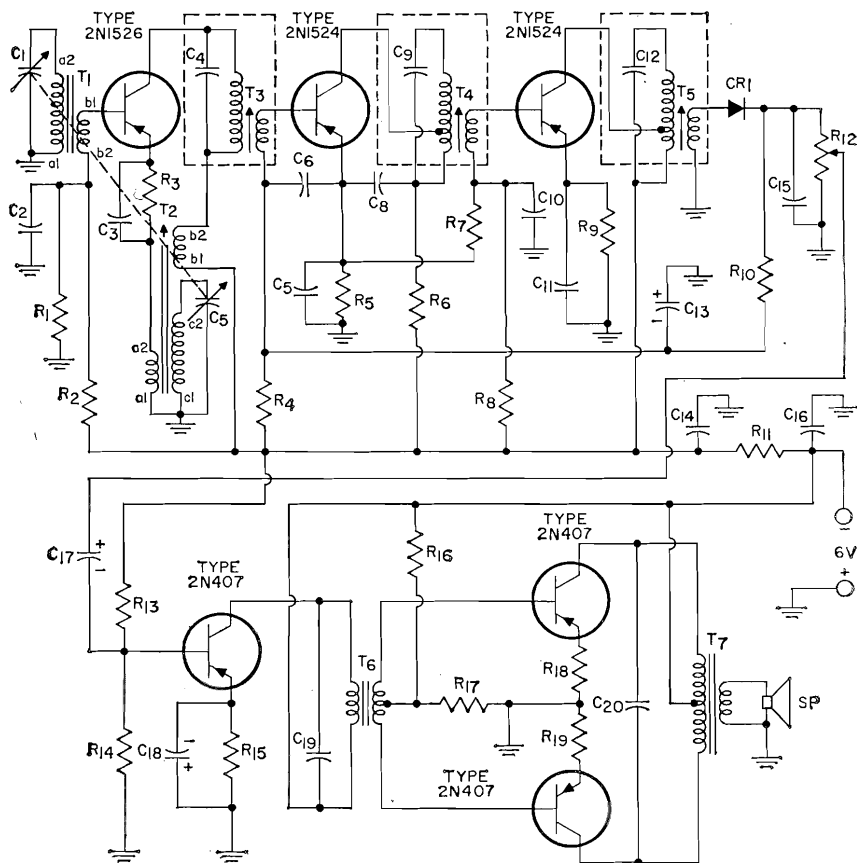

$C_1, C_6$  = ganged tuning capacitor (with trimmers);  $C_1$  = 18 to 169 pf;  $C_5$  = 17 to 88 pf; Radio Condenser No. 903-817 (vernier drive), or equiv.

$C_2, C_3, C_{15}$  = 0.02  $\mu$ f, ceramic  
 $C_4$  = 1400 pf (part of  $T_3$ )  
 $C_8, C_7, C_8, C_{10}, C_{11}$  = 0.05  $\mu$ f, ceramic

$C_9$  = 220 pf (part of  $T_4$ )  
 $C_{12}$  = 220 pf (part of  $T_5$ )  
 $C_{13}, C_{17}$  = 10  $\mu$ f, electrolytic, 3 v.

$C_{14}, C_{16}, C_{18}$  = 100  $\mu$ f, electrolytic, 6 v.  
 $C_{19}$  = 0.005  $\mu$ f, ceramic  
 $C_{20}$  = 0.1  $\mu$ f, ceramic

CR1 = detector diode, 1N295  
 $R_1, R_{16}$  = 3900 ohms, 0.5 watt

$R_2$  = 15000 ohms, 0.5 watt  
 $R_3, R_7$  = 1800 ohms, 0.5 watt

$R_4$  = 82000 ohms, 0.5 watt  
 $R_5, R_{15}$  = 470 ohms, 0.5 watt

$R_6$  = 560 ohms, 0.5 watt  
 $R_8$  = 33000 ohms, 0.5 watt  
 $R_9$  = 390 ohms, 0.5 watt

$R_{10}$  = 10000 ohms, 0.5 watt  
 $R_{11}, R_{17}$  = 100 ohms, 0.5 watt

$R_{12}$  = volume-control potentiometer, 5000 ohms, audio taper

$R_{13}$  = 27000 ohms, 0.5 watt  
 $R_{14}$  = 5600 ohms, 0.5 watt  
 $R_{18}, R_{19}$  = 3.3 ohms, 0.5 watt

$S_p$  = speaker; voice-coil impedance, 3.2 ohms

$T_1$  = antenna transformer; wound on 6-inch-long, 0.330-inch-diameter rod made of General Ceramic "Q" material, or equiv;

primary, 125 turns of No. 2/38 Litz wire (S. Nysol), 28 turns per inch; secondary, 8 turns of No. 2/38 Litz wire, bifilar wound from start ( $a_1$  end) of primary.

$T_2$  = oscillator coil; consecutively wound in following order:  $a_1$ - $a_2$  = 5 turns,  $b_1$ - $b_2$  = 9 turns,  $c_1$ - $c_2$  = 130 turns of No. 2/38 Litz wire (S. Nysol)

on  $\frac{1}{4}$ -inch-diameter coil form having a  $\frac{3}{8}$ -inch-long,  $\frac{1}{4}$ -inch diameter, 28-TPI slug made of General Ceramic "Q" material, or equiv.

$T_3$  = 1st if transformer; General Instrument No. E-2749343-AX, or equiv.

$T_4$  = 2nd if, transformer; General Instrument No. E-2749293-BZ, or equiv.

$T_5$  = 3rd if transformer; General Instrument No. E-2749293-CY, or equiv.

$T_6$  = driver transformer; primary impedance, 5000 ohms; secondary impedance, 2200 ohms, center-tapped; Mid-West Coil and Transformer No. 20AT90, or equiv.

$T_7$  = output transformer; primary impedance, 320 ohms, center-tapped; secondary impedance, 3.2 ohms; Mid-West Coil and Transformer No. 20AT89, or equiv.

$T_8$  = 1st if transformer; General Instrument No. E-2749293-BZ, or equiv.

$T_9$  = 2nd if transformer; General Instrument No. E-2749293-CY, or equiv.

$T_{10}$  = 3rd if transformer; General Instrument No. E-2749293-CY, or equiv.

$T_{11}$  = driver transformer; primary impedance, 5000 ohms; secondary impedance, 2200 ohms, center-tapped; Mid-West Coil and Transformer No. 20AT90, or equiv.

$T_{12}$  = output transformer; primary impedance, 320 ohms, center-tapped; secondary impedance, 3.2 ohms; Mid-West Coil and Transformer No. 20AT89, or equiv.

## 11-3

## 6-VOLT AUTOMOBILE RADIO RECEIVER

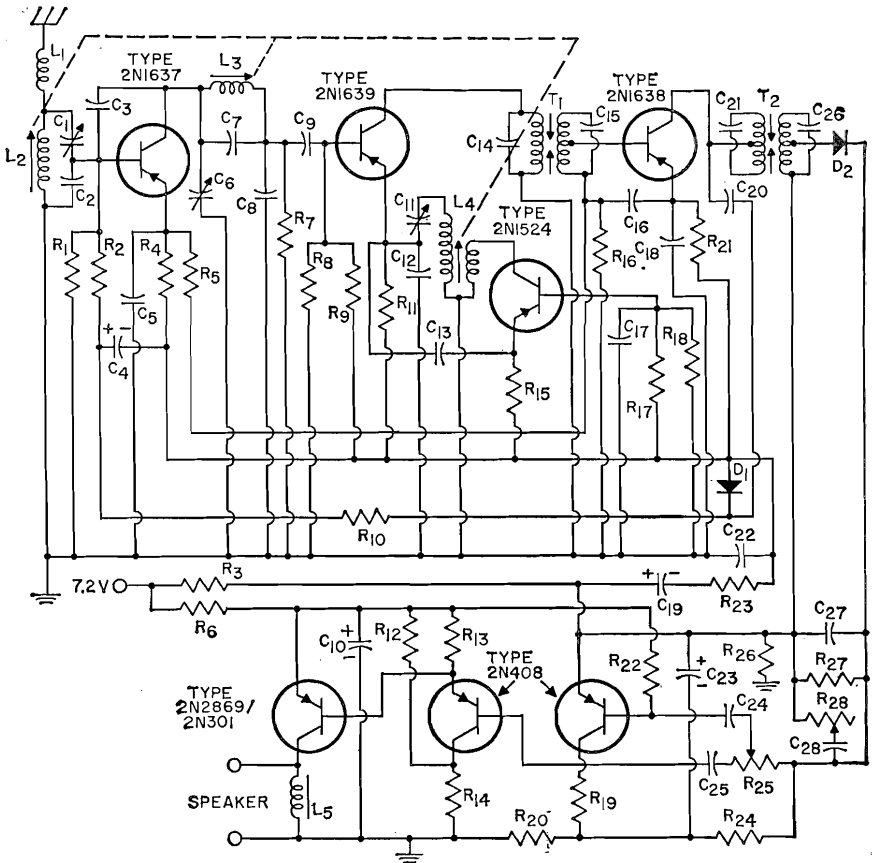

**C<sub>1</sub>** = 5-80 pf, variable trimmer  
**C<sub>2</sub>** = 820 pf, mica, 100 v.  
**C<sub>3</sub>** = 2 pf, mica, 100 v.  
**C<sub>4</sub>** **C<sub>23</sub>** = 25  $\mu$ f, electrolytic, 6 v.  
**C<sub>5</sub>** **C<sub>9</sub>** **C<sub>13</sub>** **C<sub>16</sub>** **C<sub>17</sub>** **C<sub>18</sub>** = 0.05  $\mu$ f, ceramic disc  
**C<sub>6</sub>** **C<sub>7</sub>** = 100-580 pf, variable trimmer  
**C<sub>7</sub>** = 270 pf, mica  
**C<sub>8</sub>** = 0.005  $\mu$ f, ceramic disc  
**C<sub>10</sub>** **C<sub>22</sub>** = 50  $\mu$ f, electrolytic, 6 v.  
**C<sub>12</sub>** = 0.0047  $\mu$ f, ceramic disc  
**C<sub>14</sub>** **C<sub>15</sub>** = supplied with T<sub>1</sub>  
**C<sub>19</sub>** = 500  $\mu$ f, electrolytic, 3 v.  
**C<sub>20</sub>** = 180 pf, mica, 100 v.  
**C<sub>21</sub>** **C<sub>26</sub>** = supplied with T<sub>2</sub>  
**C<sub>24</sub>** **C<sub>28</sub>** = 1  $\mu$ f, ceramic disc, 3 v.  
**C<sub>27</sub>** = 0.04  $\mu$ f, ceramic disc, 25 v.  
**C<sub>28</sub>** = 0.5  $\mu$ f, ceramic disc, 25 v.  
**D<sub>1</sub>** **D<sub>2</sub>** = 1N295  
**L<sub>1</sub>** = 5  $\mu$ f, rf choke

**L<sub>2</sub>** **L<sub>3</sub>** **L<sub>4</sub>** = tuner assembly; manufactured by F. W. Sickles Co. and Radio Condenser Corp.  
**L<sub>2</sub>** = antenna coil; variable inductor tuned with 110 pf; frequency range 535 to 1610 kc; Q = 65 at 1610 kc  
**L<sub>3</sub>** = rf coil; variable inductor tuned with 600 pf; frequency range 535 to 1610 kc; Q = 65 at 1610 kc  
**L<sub>4</sub>** = oscillator transformer; primary, variable inductor tuned with 470 pf; frequency range 797 to 1872 kc; Q = 65 at 1872 kc; secondary, 30 turns  
**L<sub>5</sub>** = output choke; 20 mh; 1 ampere, 0.5 ohm max.  
**R<sub>1</sub>** = 82000 ohms, 0.5 watt  
**R<sub>2</sub>** = 2200 ohms, 0.5 watt  
**R<sub>3</sub>** = 33 ohms, 0.5 watt  
**R<sub>4</sub>** **R<sub>21</sub>** = 330 ohms, 0.5 watt  
**R<sub>5</sub>** **R<sub>10</sub>** = 5600 ohms, 0.5 watt  
**R<sub>6</sub>** = 0.33 ohm, 1 watt

**R<sub>7</sub>** = 180 ohms, 0.5 watt  
**R<sub>8</sub>** = 10000 ohms, 0.5 watt  
**R<sub>9</sub>** = 1500 ohms, 0.5 watt  
**R<sub>11</sub>** **R<sub>25</sub>** = 1000 ohms, 0.5 watt  
**R<sub>12</sub>** **R<sub>13</sub>** **R<sub>14</sub>** = 68 ohms, 0.5 watt  
**R<sub>15</sub>** = 820 ohms, 0.5 watt  
**R<sub>16</sub>** = 47000 ohms, 0.5 watt  
**R<sub>17</sub>** = 1800 ohms, 0.5 watt  
**R<sub>18</sub>** = 8200 ohms, 0.5 watt  
**R<sub>19</sub>** **R<sub>28</sub>** = 1200 ohms, 0.5 watt  
**R<sub>20</sub>** **R<sub>27</sub>** = 3300 ohms, 0.5 watt  
**R<sub>23</sub>** = 120 ohms, 0.5 watt  
**R<sub>24</sub>** = 100000 ohms, 0.5 watt  
**R<sub>25</sub>** = volume control, potentiometer, 10000 ohms  
**R<sub>26</sub>** = tone control, potentiometer, 10000 ohms  
**T<sub>1</sub>** = if transformer, Thompson-Ramo-Wooldridge No. E010173, General Instrument No. E2740097 AX, or equivalent  
**T<sub>2</sub>** = if transformer, Thompson-Ramo-Wooldridge No. E010174, General Instrument No. E2740097 BX, or equivalent



## 11-4 12-VOLT AUTOMOBILE RADIO RECEIVER

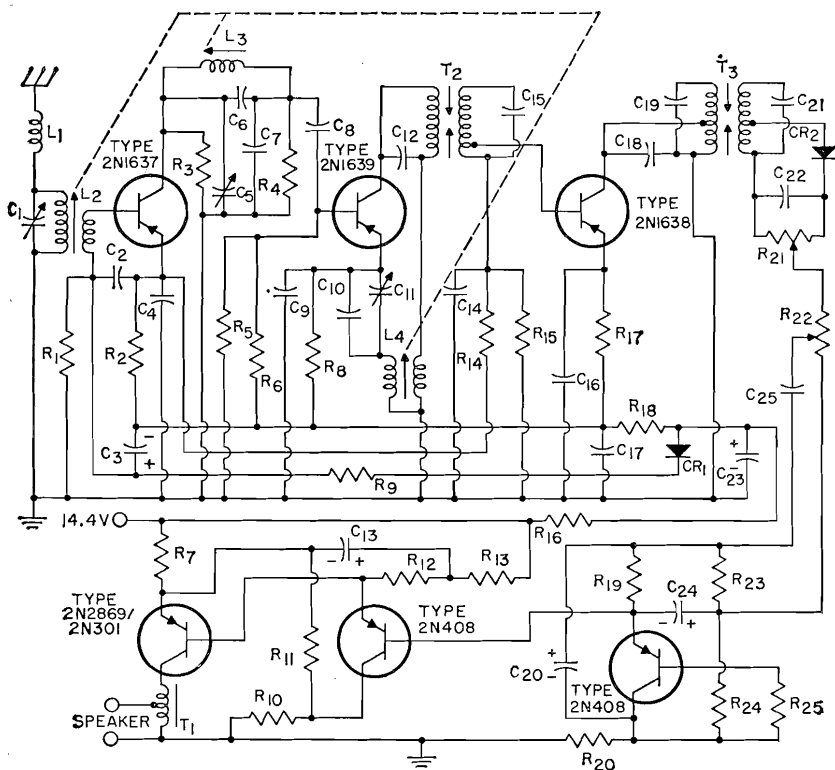

C<sub>1</sub> = 5-80 pf, trimmer  
 C<sub>2</sub> = 2.2  $\mu$ f, 3v.  
 C<sub>3</sub> = 25  $\mu$ f, electrolytic, 3 v.  
 C<sub>4</sub> C<sub>8</sub> C<sub>12</sub> C<sub>16</sub> C<sub>17</sub> C<sub>25</sub> = 0.5  $\mu$ f, ceramic disc, 25 v.  
 C<sub>5</sub> C<sub>11</sub> = 100-580 pf, trimmer  
 C<sub>6</sub> = 270 pf, mica, 100 v.  
 C<sub>7</sub> = 0.005  $\mu$ f, ceramic disc, 25 v.  
 C<sub>9</sub> = 0.0075  $\mu$ f, ceramic disc, 25 v.  
 C<sub>10</sub> = 180  $\mu$ f, ceramic, N-750, negative temperature coefficient  
 C<sub>12</sub> C<sub>15</sub> = supplied with T<sub>2</sub>  
 C<sub>13</sub> = 500  $\mu$ f, electrolytic, 3 v.  
 C<sub>18</sub> = 120 pf, mica, 100 v.  
 C<sub>19</sub> C<sub>21</sub> = supplied with T<sub>3</sub>  
 C<sub>20</sub> = 50  $\mu$ f, electrolytic, 6 v.  
 C<sub>22</sub> = 0.02  $\mu$ f, ceramic disc, 25 v.  
 C<sub>23</sub> = 100  $\mu$ f, electrolytic, 15 v.  
 C<sub>24</sub> = 100  $\mu$ f, electrolytic, 3 v.  
 CR<sub>1</sub>, CR<sub>2</sub> = 1N295  
 L<sub>1</sub> = 5  $\mu$ h, rf choke  
 L<sub>2</sub> L<sub>3</sub> L<sub>4</sub> = tuner assembly; manufactured by F. W. Sickles Co., and Radio Condenser Corp.

L<sub>2</sub> = antenna transformer; primary, variable inductor tuned with 110 pf; frequency range 535 to 1610 kc; Q = 65 at 1610 kc; secondary, 10 turns  
 L<sub>3</sub> = rf coil; variable inductor tuned with 600 pf; frequency range 535 to 1610 kc; Q = 65 at 1610 kc.  
 L<sub>4</sub> = oscillator transformer; primary, variable inductor tuned with 470 pf; frequency range 797 to 1872 kc; Q = 65 at 1872 kc; secondary, 30 turns.  
 R<sub>1</sub> = 82000 ohms, 0.5 watt  
 R<sub>2</sub> = 560 ohms, 0.5 watt  
 R<sub>3</sub> = 15000 ohms, 0.5 watt  
 R<sub>4</sub> = 180 ohms, 0.5 watt  
 R<sub>5</sub> = 56000 ohms, 0.5 watt  
 R<sub>6</sub> R<sub>20</sub> = 4700 ohms  
 R<sub>7</sub> = 3.3 ohms, 1 watt  
 R<sub>8</sub> = 1500 ohms, 0.5 watt  
 R<sub>9</sub> = 8200 ohms, 0.5 watt  
 R<sub>10</sub> = 220 ohms, 0.5 watt  
 R<sub>11</sub> = 82 ohms, 0.5 watt  
 R<sub>12</sub> = 120 ohms, 0.5 watt  
 R<sub>13</sub> = 68 ohms, 0.5 watt  
 R<sub>14</sub> = 5600 ohms, 0.5 watt

R<sub>15</sub> = 100000 ohms, 0.5 watt  
 R<sub>16</sub> = 680 ohms, 0.5 watt  
 R<sub>17</sub> = 470 ohms, 0.5 watt  
 R<sub>18</sub> = 100 ohms, 0.5 watt  
 R<sub>19</sub> = 1200 ohms, 0.5 watt  
 R<sub>21</sub> = volume control, potentiometer, 2500 ohms  
 R<sub>22</sub> = tone control, potentiometer, 1000 ohms  
 R<sub>23</sub> R<sub>25</sub> = 3300 ohms, 0.5 watt  
 R<sub>24</sub> = 33000 ohms, 0.5 watt  
 T<sub>1</sub> = output transformer; primary impedance, 20 ohms at 500 ma dc; secondary impedance, 4 ohms to match impedance of voice coil; Columbus Process Co. No. 5383, or equivalent  
 T<sub>2</sub> = if transformer, Thompson-Ramo-Wooldridge No. E014127, General Instrument Co. No. E2742208AX, or equivalent  
 T<sub>3</sub> = if transformer, Thompson-Ramo-Wooldridge No. E014128, General Instrument Co. No. E2742208BX, or equivalent

11-5 AM/FM AUTOMOBILE RADIO RECEIVER

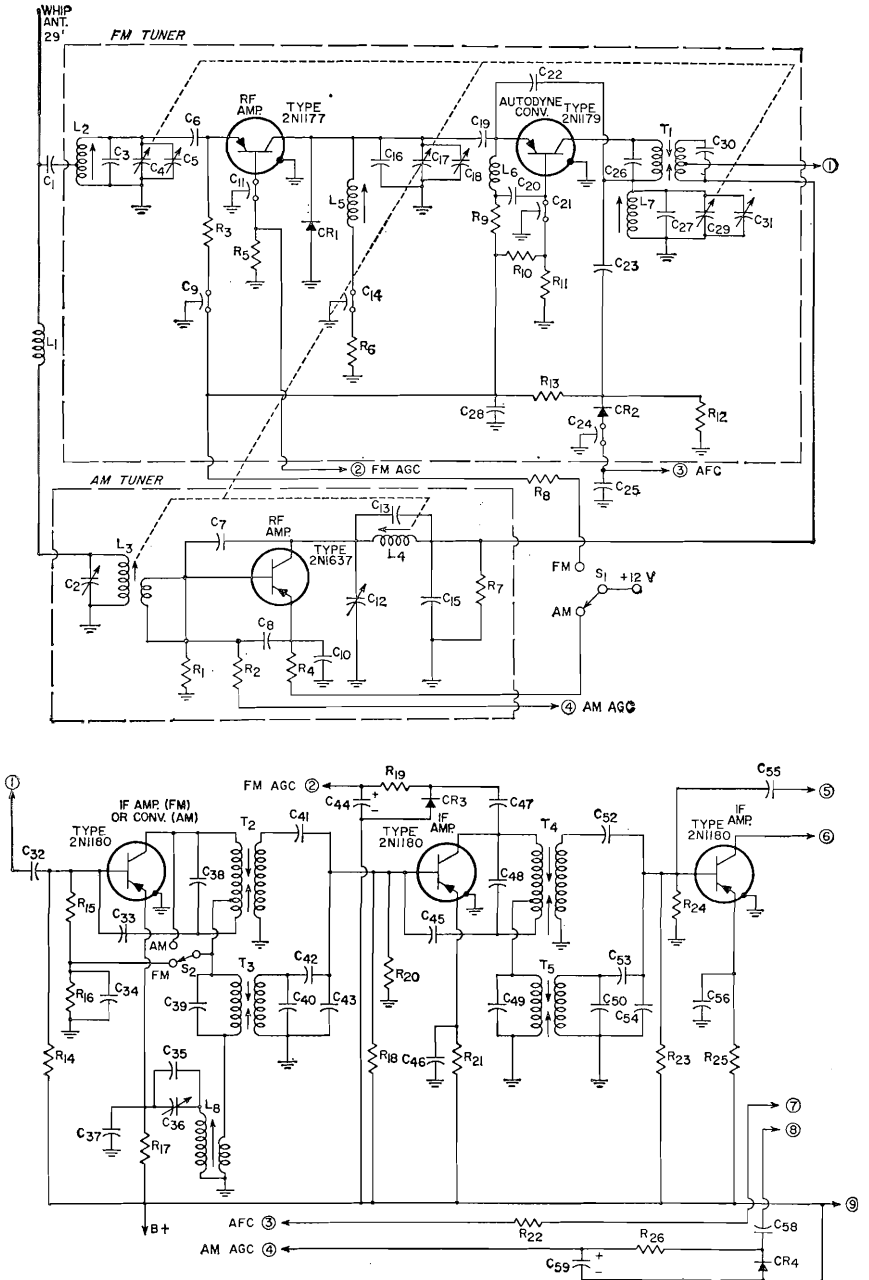

## 11-5 AM/FM AUTOMOBILE RADIO RECEIVER (cont'd)

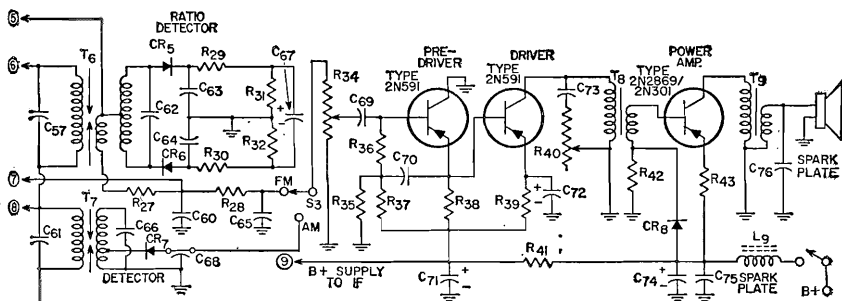

**C**<sub>1</sub> = 18 pf, ceramic disc, 50 v.  
**C**<sub>2</sub> = 5-80 pf, mica, trimmer  
**C**<sub>3</sub> **C**<sub>4</sub> **C**<sub>19</sub> **C**<sub>47</sub> = 5 pf, ceramic disc, 50 v.  
**C**<sub>4</sub> **C**<sub>17</sub> **C**<sub>59</sub> = 6-21 pf, tuning capacitor  
**C**<sub>5</sub> **C**<sub>18</sub> **C**<sub>31</sub> = 1-6 pf, mica, trimmer  
**C**<sub>7</sub> = 1.5 pf, ceramic disc, 50 v.  
**C**<sub>8</sub> **C**<sub>10</sub> **C**<sub>32</sub> **C**<sub>46</sub> **C**<sub>56</sub> **C**<sub>89</sub> **C**<sub>73</sub> = 0.05,  $\mu$ f, ceramic disc, 50 v.  
**C**<sub>9</sub> **C**<sub>11</sub> **C**<sub>14</sub> **C**<sub>21</sub> **C**<sub>24</sub> **C**<sub>68</sub> = 0.002  $\mu$ f, feedthrough, 50 v.  
**C**<sub>12</sub> = 55-300 pf, mica, trimmer  
**C**<sub>13</sub> = 390 pf, ceramic disc, 50 v.  
**C**<sub>15</sub> = 0.005  $\mu$ f, ceramic disc, 50 v.  
**C**<sub>16</sub> **C**<sub>23</sub> = 4 pf, ceramic disc, 50 v.  
**C**<sub>20</sub> = 330 pf, ceramic disc, 50 v.  
**C**<sub>22</sub> = 2.2 pf, ceramic disc, 50 v.  
**C**<sub>25</sub> **C**<sub>28</sub> **C**<sub>34</sub> **C**<sub>37</sub> **C**<sub>51</sub> **C**<sub>80</sub> **C**<sub>88</sub> = 0.01  $\mu$ f, ceramic disc, 50 v.  
**C**<sub>26</sub> **C**<sub>30</sub> = part of **T**<sub>1</sub>  
**C**<sub>27</sub> = 15 pf, ceramic disc, 50 v.  
**C**<sub>33</sub> **C**<sub>45</sub> = 3.3 pf, ceramic disc, 50 v.  
**C**<sub>35</sub> = 180 pf, N750 ceramic  
**C**<sub>38</sub> = 80-550 pf, mica, trimmer  
**C**<sub>38</sub> **C**<sub>41</sub> = part of **T**<sub>2</sub>  
**C**<sub>39</sub> **C**<sub>40</sub> **C**<sub>42</sub> = part of **T**<sub>3</sub>  
**C**<sub>43</sub> **C**<sub>54</sub> = 0.001  $\mu$ f, ceramic disc, 50 v.  
**C**<sub>44</sub> = 10  $\mu$ f, electrolytic, 25 v.  
**C**<sub>48</sub> **C**<sub>52</sub> = part of **T**<sub>4</sub>  
**C**<sub>49</sub> = 1800 pf  $\pm$  10%, ceramic disc  
**C**<sub>50</sub> **C**<sub>53</sub> = part of **T**<sub>5</sub>  
**C**<sub>55</sub> = 2 pf, ceramic disc, 50 v.  
**C**<sub>57</sub> **C**<sub>62</sub> = part of **T**<sub>6</sub>  
**C**<sub>58</sub> = 200 pf, ceramic disc, 50 v.  
**C**<sub>59</sub> = 20  $\mu$ f, electrolytic, 25 v.  
**C**<sub>61</sub> = 1500 pf  $\pm$  10%, ceramic disc  
**C**<sub>65</sub> = 0.02  $\mu$ f, ceramic disc, 50 v.  
**C**<sub>66</sub> = part of **T**<sub>7</sub>  
**C**<sub>67</sub> = 10  $\mu$ f, electrolytic, 3 v.  
**C**<sub>70</sub> = 2.2  $\mu$ f, ceramic disc, 3 v.

**C**<sub>71</sub> = 200  $\mu$ f, electrolytic, 25 v.  
**C**<sub>72</sub> = 100  $\mu$ f, electrolytic, 25 v.  
**C**<sub>74</sub> = 500  $\mu$ f, electrolytic, 25 v.  
**C**<sub>75</sub> **C**<sub>76</sub> = spark plate  
**CR**<sub>1</sub> **CR**<sub>3</sub> **CR**<sub>4</sub> **CR**<sub>7</sub> = diode, 1N295  
**CR**<sub>2</sub> = AFC diode, 1N3182 or equiv.  
**CR**<sub>5</sub> **CR**<sub>6</sub> = diode, 1N542  
**CR**<sub>8</sub> = diode, 1N1763  
**L**<sub>1</sub> = 6.2  $\mu$ h, radio-frequency choke  
**L**<sub>2</sub> = antenna coil for FM tuner; 4 turns No. 16 HF on 0.220-inch form, spaced  $\frac{1}{16}$ -inch (approx.); tapped at 1 turn; core "J" material Arnold A1-336 or equiv.  
**L**<sub>3</sub> = antenna coil for AM tuner; variable inductor; tunes with 120 pf over the frequency range from 535 to 1610 kc; **Q**<sub>0</sub> = 60 at 1610 kc; secondary 8 turns  
**L**<sub>4</sub> = rf coil for AM tuner; variable inductor; tunes with 560 pf over the frequency range from 535 to 1610 kc; **Q**<sub>0</sub> = 60 at 1610 kc; no secondary  
**L**<sub>5</sub> = rf coil for FM tuner; same as **L**<sub>2</sub> except has no tap  
**L**<sub>6</sub> = miniature radio-frequency choke, 1  $\mu$ h (approx.)  
**L**<sub>7</sub> = oscillator coil for FM tuner; 3 turns No. 16 HF on 0.220-inch form, spaced  $\frac{1}{16}$ -inch (approx.); core "J" material Arnold A1-336 or equiv.  
**L**<sub>8</sub> = oscillator coil for AM tuner; variable inductor; tunes with 470 pf over the frequency range from 797 to 1872 kc; **Q**<sub>0</sub> = 45 at 1872 kc; secondary 30 turns  
**L**<sub>9</sub> = filter choke, 125  $\mu$ h (approx.)  
**R**<sub>1</sub> **R**<sub>12</sub> **R**<sub>23</sub> = 100000 ohms, 0.5 watt  
**R**<sub>2</sub> **R**<sub>4</sub> = 560 ohms, 0.5 watt  
**R**<sub>3</sub> = 390 ohms, 0.5 watt  
**R**<sub>5</sub> **R**<sub>11</sub> **R**<sub>18</sub> = 33000 ohms, 0.5 watt

**R**<sub>6</sub> **R**<sub>27</sub> **R**<sub>41</sub> = 180 ohms, 0.5 watt  
**R**<sub>7</sub> = 68 ohms, 0.5 watt  
**R**<sub>8</sub> = 220 ohms, 0.5 watt  
**R**<sub>9</sub> = 680 ohms, 0.5 watt  
**R**<sub>10</sub> = 4300 ohms, 0.5 watt  
**R**<sub>13</sub> = 1 megohm, 0.5 watt  
**R**<sub>14</sub> **R**<sub>15</sub> = 10000 ohms, 0.5 watt  
**R**<sub>17</sub> **R**<sub>30</sub> = 1500 ohms, 0.5 watt  
**R**<sub>18</sub> **R**<sub>23</sub> = 2200 ohms, 0.5 watt  
**R**<sub>19</sub> **R**<sub>20</sub> = 5600 ohms, 0.5 watt  
**R**<sub>20</sub> **R**<sub>24</sub> = 18000 ohms, 0.5 watt  
**R**<sub>21</sub> **R**<sub>25</sub> **R**<sub>36</sub> = 470 ohms, 0.5 watt  
**R**<sub>28</sub> = 3900 ohms, 0.5 watt  
**R**<sub>30</sub> = 1000 ohms, 0.5 watt  
**R**<sub>31</sub> **R**<sub>32</sub> **R**<sub>37</sub> = 6800 ohms, 0.5 watt  
**R**<sub>34</sub> = potentiometer, 100000 ohms, 0.5 watt, audio taper  
**R**<sub>35</sub> = 62000 ohms, 0.5 watt  
**R**<sub>36</sub> = 4700 ohms, 0.5 watt  
**R**<sub>38</sub> = 3300 ohms, 0.5 watt  
**R**<sub>40</sub> = potentiometer, 250000 ohms, 0.5 watt, audio taper  
**R**<sub>42</sub> = 270 ohms, 1 watt  
**R**<sub>43</sub> = 0.47 ohm, 0.5 watt  
**T**<sub>1</sub> = FM if transformer; Thompson - Ramo - Wooldridge No. 12224 or General Instrument No. E2741353AX or equiv.  
**T**<sub>2</sub> **T**<sub>4</sub> = FM if transformer; Thompson - Ramo - Wooldridge No. 12080R1 or General Instrument No. E274166BX or equiv.  
**T**<sub>3</sub> = AM if transformer; Thompson - Ramo - Wooldridge No. 12414 or equiv.  
**T**<sub>5</sub> = AM if transformer; Thompson - Ramo - Wooldridge No. 12415 or equiv.  
**T**<sub>6</sub> = radio-detector transformer; Thompson-Ramo-Wooldridge No. 12007R1 or General Instrument No. E274166AB or equiv.  
**T**<sub>7</sub> = AM if transformer; Thompson - Ramo - Wooldridge No. 12416 or equiv.  
**T**<sub>8</sub> = driver transformer; primary 8000 ohms at 3 ma dc; secondary 60 ohms; Columbus Process Co. No. X5357 or equiv.  
**T**<sub>9</sub> = output transformer; primary 20 ohms at 700 ma dc; secondary 4 ohms; Columbus Process Co. No. 5383 or equiv.

11-6

THREE-BAND RADIO RECEIVER

for  
Long-wave (150-400 Kc)  
Broadcast (535-1620 Kc)  
Shortwave (1.7-5 Mc)

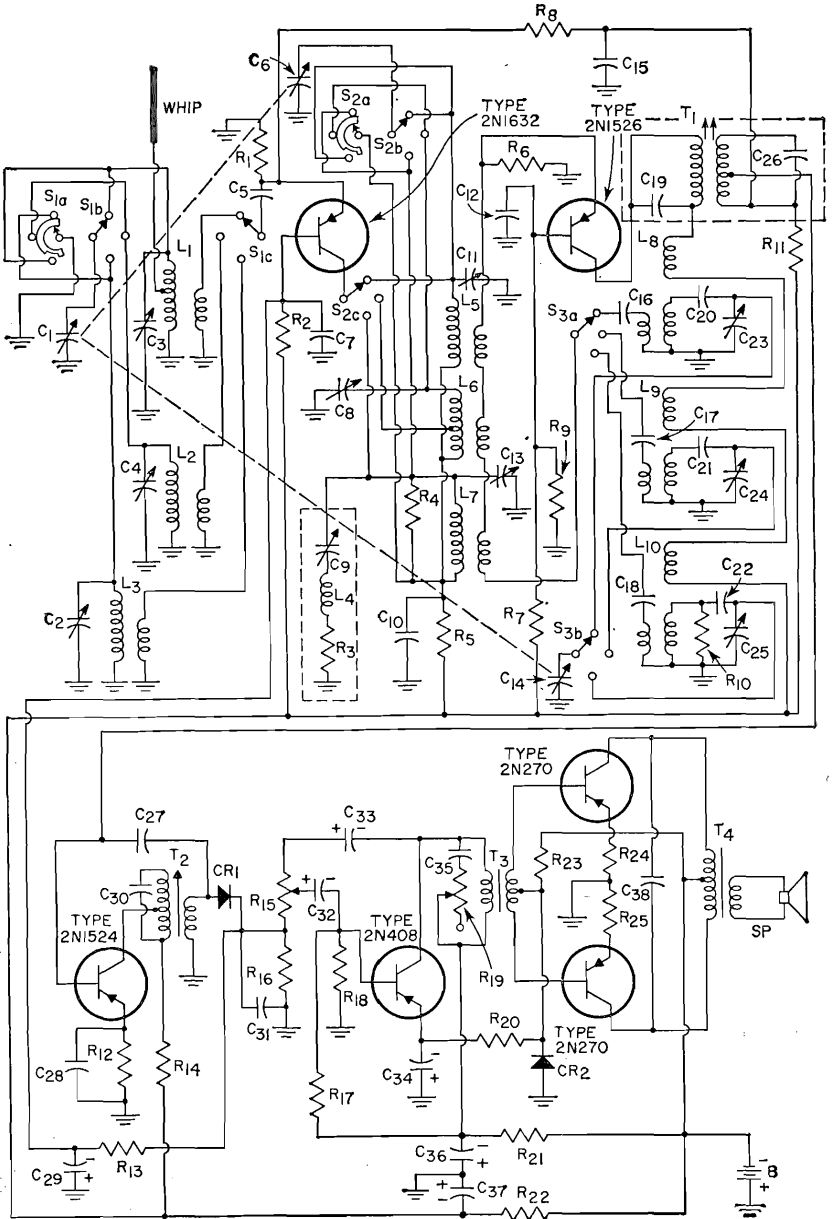

77-6 THREE-BAND RADIO RECEIVER (cont'd)

- B = 9 volts
- C<sub>1</sub> C<sub>3</sub> C<sub>14</sub> = variable, 26.1 to 251 pf
- C<sub>2</sub> C<sub>3</sub> C<sub>4</sub> C<sub>23</sub> C<sub>24</sub> C<sub>26</sub> = trimmer, 3-35 pf, Arco 403, or equivalent
- C<sub>5</sub> = 0.25  $\mu$ f, ceramic disc
- C<sub>7</sub> C<sub>10</sub> C<sub>15</sub> C<sub>28</sub> = 0.05  $\mu$ f, ceramic disc
- C<sub>9</sub> C<sub>11</sub> C<sub>13</sub> = trimmer, 1.5-20 pf, Arco 402, or equivalent
- C<sub>12</sub> C<sub>25</sub> = 0.01  $\mu$ f, ceramic disc
- C<sub>16</sub> = 0.0005  $\mu$ f, ceramic disc
- C<sub>17</sub> C<sub>18</sub> C<sub>21</sub> = 0.02  $\mu$ f, ceramic disc
- C<sub>19</sub> C<sub>29</sub> = 350 pf, part of T<sub>1</sub>
- C<sub>20</sub> = 900 pf, silver mica
- C<sub>21</sub> = 300 pf, silver mica
- C<sub>22</sub> = 91 pf, silver mica
- C<sub>27</sub> = 10 pf, ceramic disc
- C<sub>29</sub> = 10  $\mu$ f, 3 volts, electrolytic
- C<sub>30</sub> = 220 pf, ceramic disc, supplied with T<sub>2</sub>
- C<sub>32</sub> = 2  $\mu$ f, 3 volts, electrolytic
- C<sub>33</sub> = 10  $\mu$ f, 3 volts, electrolytic
- C<sub>34</sub> = 100  $\mu$ f, 3 volts, electrolytic
- C<sub>35</sub> = 0.04  $\mu$ f, ceramic disc
- C<sub>36</sub> C<sub>37</sub> = 100  $\mu$ f, 10 volts, electrolytic
- L<sub>1</sub> = 42  $\mu$ h at 3100 kc, short-wave antenna coil, Q<sub>0</sub> = 75; turns ratio N<sub>1</sub>/N<sub>2</sub>, 1.67:1; N<sub>2</sub>/N<sub>3</sub>, 18:1
- L<sub>2</sub> = 380  $\mu$ h at 1000 kc, broadcast, antenna coil, Q<sub>0</sub> = 184; turns ratio N<sub>1</sub>/N<sub>2</sub>, 78:1
- L<sub>3</sub> = 4600  $\mu$ h at 270 kc, long-wave antenna coil, Q<sub>0</sub> = 69; turns ratio N<sub>1</sub>/N<sub>3</sub>, 91:1
- L<sub>4</sub> = 5  $\mu$ h, part of if trap
- L<sub>5</sub> = 34  $\mu$ h at 3100 kc, short-

- wave RF coil, Q<sub>0</sub> = 81; turns ratio, N<sub>1</sub>/N<sub>3</sub>, 87:1
- L<sub>6</sub> = 370  $\mu$ h at 1000 kc, broadcast RF coil, Q<sub>0</sub> = 80; turns ratio, N<sub>1</sub>/N<sub>2</sub>, 2.5:1; N<sub>2</sub>/N<sub>3</sub>, 25:1
- L<sub>7</sub> = 4200  $\mu$ h at 270 kc, long-wave RF coil, Q<sub>0</sub> = 10; turns ratio N<sub>1</sub>/N<sub>3</sub>, 91:1 (measured with 100000-ohm shunt)
- L<sub>8</sub> = 29  $\mu$ h at 3550 kc, short-wave oscillator coil, Q<sub>0</sub> = 20; turns ratio N<sub>1</sub>/N<sub>2</sub>, 25:1, N<sub>1</sub>/N<sub>3</sub>, 4:1
- L<sub>9</sub> = 200  $\mu$ h at 1455 kc, broadcast oscillator coil, Q<sub>0</sub> = 39; turns ratio N<sub>1</sub>/N<sub>2</sub>, 29:1, N<sub>1</sub>/N<sub>3</sub>, 13:1
- L<sub>10</sub> = 1100  $\mu$ h at 725 kc, long-wave oscillator coil, Q<sub>0</sub> = 17; turns ratio N<sub>1</sub>/N<sub>2</sub>, 21:1, N<sub>1</sub>/N<sub>3</sub>, 12:1 (measured with 200000-ohm shunt)
- R<sub>1</sub> = 270 ohms, 0.5 watt
- R<sub>2</sub> = 150000 ohms, 0.5 watt
- R<sub>3</sub> = 22000 ohms, 0.5 watt
- R<sub>4</sub> = 100000 ohms, 0.5 watt
- R<sub>5</sub> = 560 ohms, 0.5 watt
- R<sub>6</sub> = 1800 ohms, 0.5 watt
- R<sub>7</sub> = 18000 ohms, 0.5 watt
- R<sub>8</sub> = 1200 ohms, 0.5 watt
- R<sub>9</sub> = 3300 ohms, 0.5 watt
- R<sub>10</sub> = 200000 ohms, 0.5 watt
- R<sub>11</sub> = 47000 ohms, 0.5 watt
- R<sub>12</sub> = 270 ohms, 0.5 watt
- R<sub>13</sub> = 10000 ohms, 0.5 watt
- R<sub>14</sub> = 1000 ohms, 0.5 watt
- R<sub>15</sub> = volume control, 1 megohm, reverse log. taper
- R<sub>16</sub> = 4000 ohms, 0.5 watt
- R<sub>17</sub> = 27000 ohms, 0.5 watt
- R<sub>18</sub> = 4700 ohms, 0.5 watt
- R<sub>19</sub> = tone control, 1 megohm, audio taper

- R<sub>20</sub> = 560 ohms, 0.5 watt
  - R<sub>21</sub> = 330 ohms, 0.5 watt
  - R<sub>22</sub> = 100 ohms, 0.5 watt
  - R<sub>23</sub> = 4.7 ohms, 0.5 watt
  - R<sub>24</sub> = 3.9 ohms, 0.5 watt
  - R<sub>25</sub> = 3.9 ohms, 0.5 watt
  - S<sub>14</sub>-S<sub>30</sub> = three-section wafers switch
  - S<sub>P</sub> = speaker, 3.2 ohms
  - T<sub>1</sub> = first if transformer (455 kc): double-tuned critical coupling, General Instrument No. E-2,749,067EX, or equivalent
  - T<sub>2</sub> = second if transformer (455 kc): single-tuned, General Instrument No. E-2,749,067CX, or equivalent
  - T<sub>3</sub> = driver transformer: primary 10000 ohms, secondary, 2000 ohms, center tapped; Mid-West Coil and Transformer Co. No. 20AT88, or equivalent
  - T<sub>4</sub> = output transformer: primary, 250 ohms center tapped; secondary, 3.2 ohms; Mid-West Coil and Transformer Co. No. 20-AT86, or equivalent
- NOTE 1: Components C<sub>9</sub>, L<sub>4</sub>, and R<sub>3</sub> make up an if trap in the long-wave band and are used to improve if rejection and signal-to-noise ratio.
- NOTE 2: For the antenna and rf coils, N<sub>1</sub> refers to the turns of the primary winding, N<sub>2</sub> to the tapped portion of the primary, and N<sub>3</sub> to the secondary. For the oscillator coils, N<sub>1</sub> refers to the tank winding, N<sub>2</sub> to the emitter winding, and N<sub>3</sub> to the collector winding.

77-7 "FRONT-END" FOR RADIO RECEIVER

With Double-Tuned Antenna and Single-Tuned RF Stage

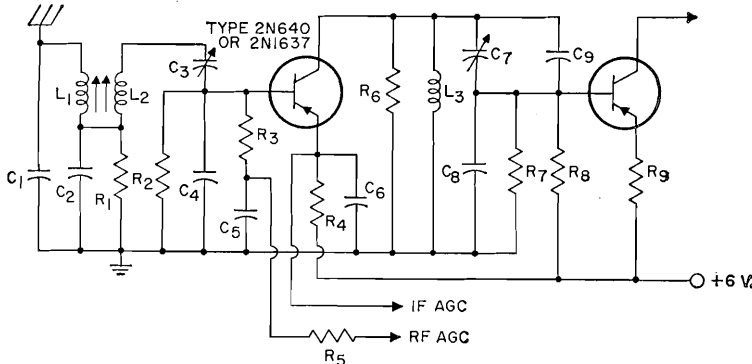

- C<sub>1</sub> = 3-50 pf, variable
- C<sub>2</sub> = 0.01  $\mu$ f, ceramic disc, 25 v.
- C<sub>3</sub> = 30-200 pf, variable
- C<sub>4</sub> = 1000 pf, mica
- C<sub>5</sub> C<sub>6</sub> = 0.05  $\mu$ f, ceramic disc, 25 v.
- C<sub>7</sub> = 120-450 pf, variable
- C<sub>8</sub> = 0.004  $\mu$ f, ceramic disc, 25 v.

- C<sub>9</sub> = 680 pf, mica
- L<sub>1</sub> L<sub>2</sub> = antenna coils, variable inductors tuned with 110 pf; frequency range 535 to 1610 kc; Q = 65 at 1610 k, 60 to 65 at 535 kc
- L<sub>3</sub> = rf coil; variable inductor tuned with 1000 pf; frequency range 535 to

- 1610 kc; Q = 65 at 1610 kc.
- R<sub>1</sub> R<sub>4</sub> R<sub>5</sub> = 330 ohms, 0.5 watt
- R<sub>2</sub> = 82000 ohms, 0.5 watt
- R<sub>3</sub> = 2200 ohms, 0.5 watt
- R<sub>6</sub> = 6800 ohms, 0.5 watt
- R<sub>7</sub> = 10000 ohms, 0.5 watt
- R<sub>8</sub> = 1500 ohms, 0.5 watt
- R<sub>9</sub> = 1000 ohms, 0.5 watt

77-8 PREAMPLIFIER FOR PHONO/FM PICKUP

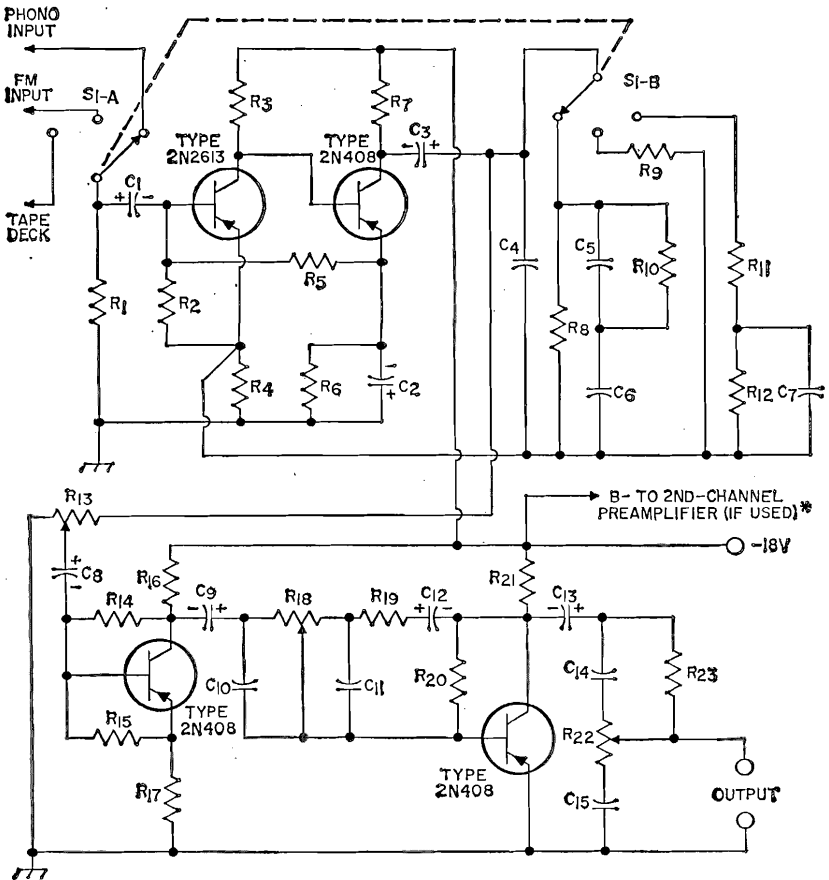

- C<sub>1</sub> = 25  $\mu$ f, miniature electrolytic, 3 v.
- C<sub>2</sub> = 50  $\mu$ f, miniature electrolytic, 3 v.
- C<sub>3</sub> = 50  $\mu$ f, miniature electrolytic, 15 v.
- C<sub>4</sub> = 270 pf, ceramic, 600 v.
- C<sub>5</sub>, C<sub>15</sub> = 0.05  $\mu$ f, ceramic, 50 v.
- C<sub>6</sub> = 0.2  $\mu$ f, ceramic, 25 v.
- C<sub>7</sub> = 0.06  $\mu$ f, ceramic, 50 v.
- C<sub>8</sub> = 4  $\mu$ f, miniature electrolytic, 3 v.
- C<sub>9</sub>, C<sub>13</sub> = 2  $\mu$ f, miniature electrolytic, 12 v.
- C<sub>10</sub> = 0.15  $\mu$ f, ceramic, 50 v.
- C<sub>11</sub> = 0.12  $\mu$ f, ceramic, 50 v.
- C<sub>12</sub> = 10  $\mu$ f, miniature electrolytic, 12 v.
- C<sub>14</sub> = 0.003  $\mu$ f, mica, 500 v.
- R<sub>1</sub> = 1 megohm  $\pm$  10%, 0.5 watt
- R<sub>2</sub> = 15000 ohms  $\pm$  10%, 0.5 watt
- R<sub>3</sub> = 47000 ohms  $\pm$  10%, 0.5 watt

- R<sub>4</sub> = 100 ohms  $\pm$  10%, 0.5 watt
- R<sub>5</sub> = 0.18 megohms  $\pm$  10%, 0.5 watt
- R<sub>6</sub> = 330 ohms  $\pm$  10%, 0.5 watt
- R<sub>7</sub> = 1800 ohms  $\pm$  10%, 0.5 watt
- R<sub>8</sub>, R<sub>23</sub> = 27000 ohms  $\pm$  10%, 0.5 watt
- R<sub>9</sub> = 1000 ohms  $\pm$  10%, 0.5 watt
- R<sub>10</sub> = 1500 ohms  $\pm$  10%, 0.5 watt
- R<sub>11</sub> = 820 ohms  $\pm$  10%, 0.5 watt
- R<sub>12</sub>, R<sub>20</sub> = 0.1 megohm  $\pm$  10%, 0.5 watt
- R<sub>13</sub> = volume control potentiometer (audio taper), 10000 ohms, 0.5 watt
- R<sub>14</sub> = 56000 ohms  $\pm$  10%, 0.5 watt
- R<sub>15</sub> = 6800 ohms  $\pm$  10%, 0.5 watt

- R<sub>16</sub> = 2700 ohms  $\pm$  10%, 0.5 watt
  - R<sub>17</sub> = 180 ohms  $\pm$  10%, 0.5 watt
  - R<sub>18</sub> = base control potentiometer (linear taper), 50000 ohms, 0.5 watt
  - R<sub>19</sub> = 2700 ohms  $\pm$  10%, 0.5 watt
  - R<sub>21</sub> = 3300 ohms  $\pm$  10%, 0.5 watt
  - R<sub>22</sub> = treble control potentiometer (audio taper), 0.1 megohm, 0.5 watt
- S<sub>1</sub> = 2-pole, 3-position rotary switch
- \* If a two-channel system is used, R<sub>13</sub>, R<sub>18</sub>, and R<sub>22</sub> should be dual controls, one control section for each preamplifier, and S<sub>1</sub> should be a 4-pole switch (Centralab No. PA 1012, or equiv.), two poles per channel. All other components are duplicated in the second preamplifier.

11-9

EARPHONE AMPLIFIER

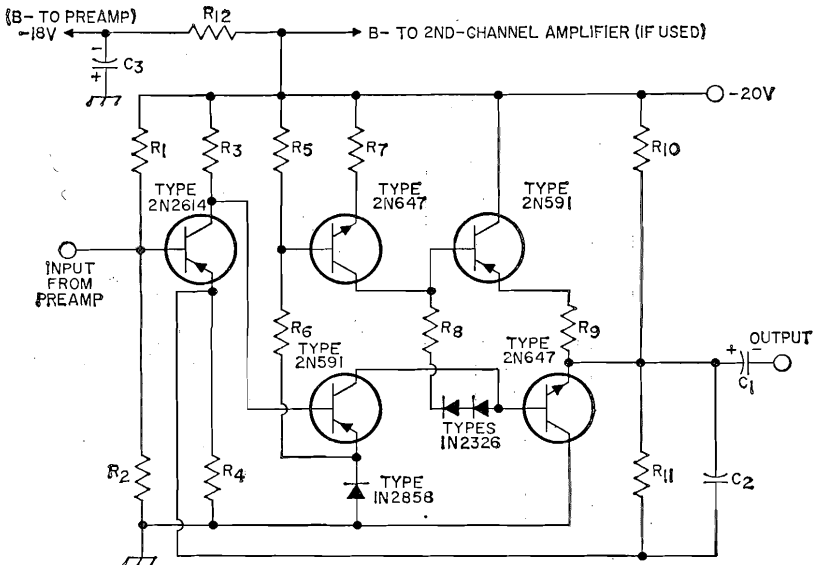

C<sub>1</sub> = 250  $\mu$ f, miniature electrolytic, 15 v.  
 C<sub>2</sub> = 500 pf, mica, 50 v.  
 C<sub>3</sub> = 500  $\mu$ f, miniature electrolytic, 50 v.  
 R<sub>1</sub> = 0.18 megohms  $\pm$  10%, 0.5 watt  
 R<sub>2</sub>, R<sub>10</sub>, R<sub>11</sub> = 3300 ohms  $\pm$  10%, 0.5 watt

R<sub>3</sub> = 47000 ohms  $\pm$  10%, 0.5 watt  
 R<sub>4</sub> = 68 ohms  $\pm$  10%, 0.5 watt  
 R<sub>5</sub> = 180 ohms  $\pm$  10%, 0.5 watt  
 R<sub>6</sub> = 10000 ohms  $\pm$  10%, 0.5 watt

R<sub>7</sub> = 47 ohms  $\pm$  10%, 0.5 watt  
 R<sub>8</sub> = 18 ohms  $\pm$  10%, 0.5 watt  
 R<sub>9</sub> = 10 ohms  $\pm$  10%, 0.5 watt  
 R<sub>12</sub> = 100 ohms  $\pm$  10%, 0.5 watt

11-10

PHONOGRAPH AMPLIFIER

Output 200 mw

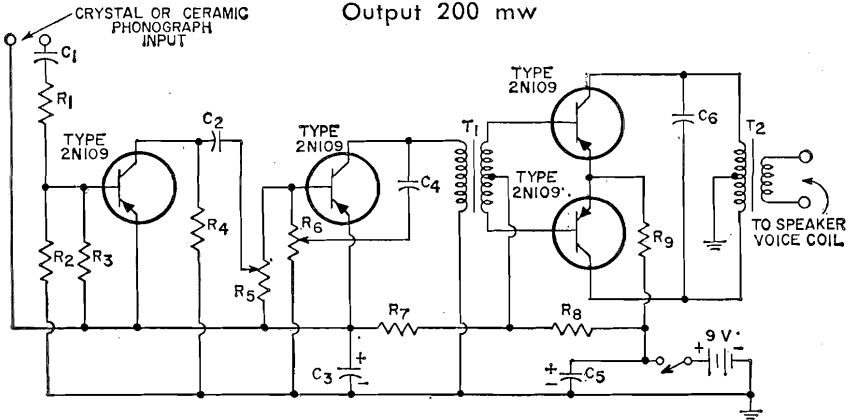

C<sub>1</sub> = 0.01  $\mu$ f, ceramic disc  
 C<sub>2</sub> = 1  $\mu$ f, ceramic disc  
 C<sub>3</sub>, C<sub>5</sub> = 50  $\mu$ f, electrolytic, 12 v.  
 C<sub>4</sub> = 0.002  $\mu$ f, ceramic disc  
 C<sub>6</sub> = 0.04  $\mu$ f, ceramic disc  
 R<sub>1</sub> = 1 megohm, 0.5 watt  
 R<sub>2</sub> = 22000 ohms, 0.5 watt  
 R<sub>3</sub> = 4700 ohms, 0.5 watt  
 R<sub>4</sub> = 1500 ohms, 0.5 watt

R<sub>5</sub> = volume-control potentiometer, 5000 ohms, logarithmic audio taper  
 R<sub>6</sub> = tone-control potentiometer, 100000 ohms, linear taper  
 R<sub>7</sub> = 680 ohms, 0.5 watt  
 R<sub>8</sub> = 27 ohms, 0.5 watt  
 R<sub>9</sub> = 33 ohms, 0.5 watt  
 T<sub>1</sub> = driver transformer;

primary impedance 3000 ohms; secondary impedance (base-to-base) 5000 ohms.  
 T<sub>2</sub> = output transformer; primary impedance (collector-to-collector) 550 ohms; secondary impedance to match speaker voice coil

## 11-11 25-WATT, HIGH-QUALITY AUDIO POWER AMPLIFIER

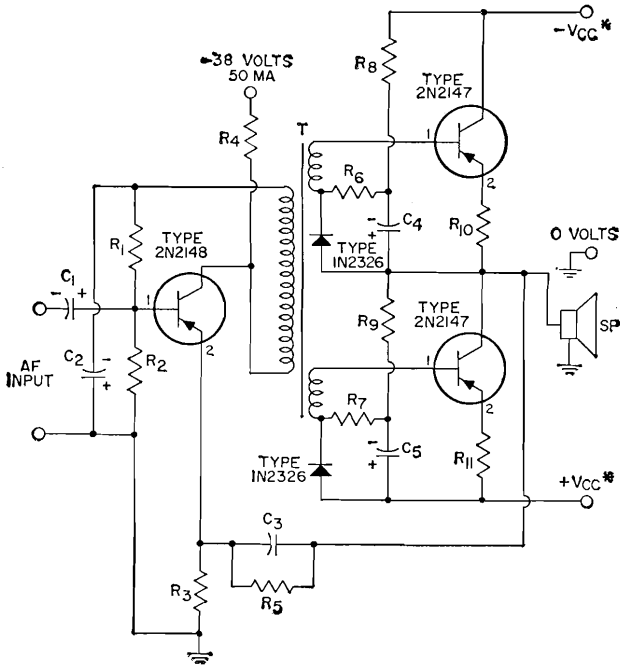

## Performance Specifications:

Sensitivity = 0.35 volt rms for 25 watts output

Frequency response = 20 to 20,000 cps  $\pm$  1 db

Input resistance = 180 ohms

C<sub>1</sub> = 200  $\mu$ f, electrolytic, 6 v.C<sub>2</sub> = 250  $\mu$ f, electrolytic,  
15 v.C<sub>3</sub> = 0.015  $\mu$ f, paper, 200 v.C<sub>4</sub>, C<sub>5</sub> = 100  $\mu$ f, electrolytic,  
50 voltsR<sub>1</sub> = 2700 ohms, 0.5 wattR<sub>2</sub> = 180 ohms, 0.5 wattR<sub>3</sub> = 4.7 ohms, 0.5 wattR<sub>4</sub> = 560 ohms, 2 wattsR<sub>5</sub> = 150 ohms, 5 wattsR<sub>6</sub>, R<sub>7</sub> = 120 ohms, 1 wattR<sub>8</sub>, R<sub>9</sub> = 180 ohms, 2 wattsR<sub>10</sub>, R<sub>11</sub> = 0.27 ohm, 0.5 wattS<sub>p</sub> = dynamic speaker;  
voice-coil impedance = 4  
ohms; voice-coil dc re-  
sistance = 3.2 ohmsT<sub>1</sub> = driver transformer;  
turns ratio, primary to  
each secondary = 4:1;  
primary impedance = 1600  
ohms; primary dc = 0 ma;  
Better Coil and Trans-  
former type 99A7, or  
equivalent\* + V<sub>ccr</sub> - V<sub>cc</sub>: Zero-signal value = 22 volts; I = 150 ma,

Maximum-signal value = 20 volts, I = 1 amp.



## 11-12

## FM STEREO MULTIPLEX ADAPTER

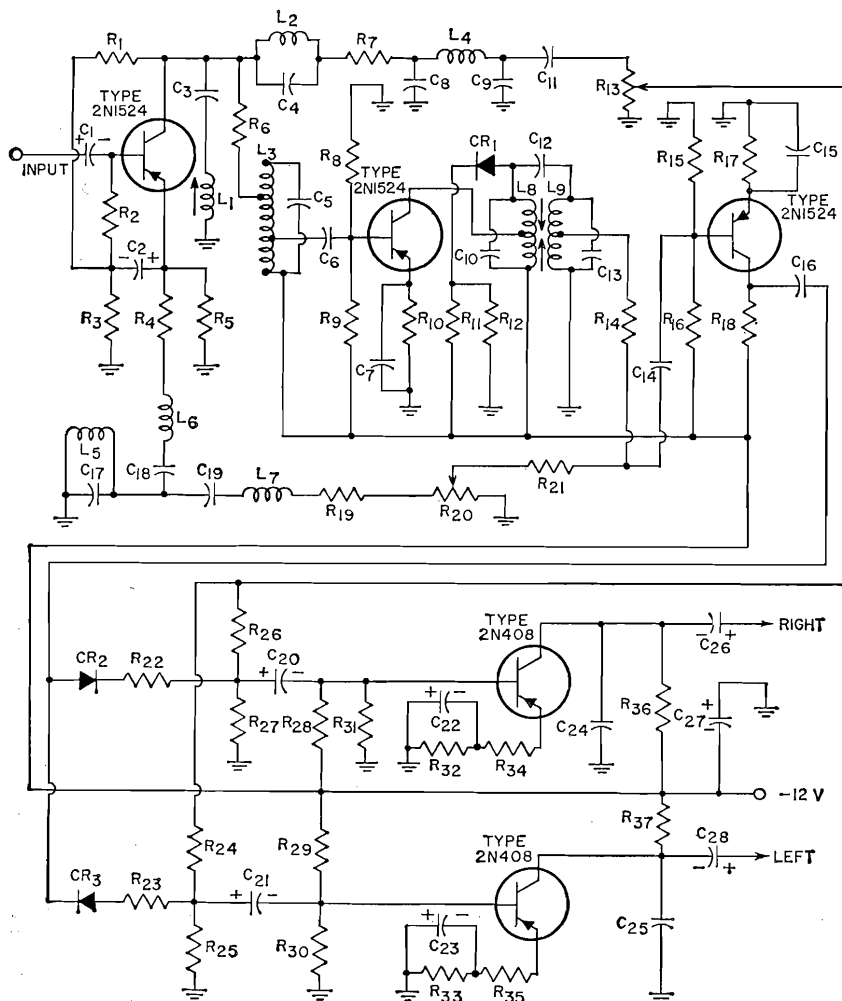

C<sub>1</sub> C<sub>20</sub> C<sub>21</sub> = 10  $\mu$ f, electrolytic, 3 v.

C<sub>2</sub> = 100  $\mu$ f, electrolytic, 3 v.

C<sub>3</sub> = 390 pf, mica

C<sub>4</sub> C<sub>5</sub> = 1000 pf, ceramic disc

C<sub>6</sub> C<sub>14</sub> C<sub>16</sub> = 0.05  $\mu$ f, ceramic disc

C<sub>7</sub> = 1  $\mu$ f, ceramic disc, 3 v.

C<sub>8</sub> C<sub>9</sub> = 1500 pf, mica

C<sub>10</sub> C<sub>13</sub> = 390 pf, ceramic disc

C<sub>11</sub> = 0.75  $\mu$ f, mica

C<sub>12</sub> = 5 pf, mica

C<sub>15</sub> = 0.47  $\mu$ f, mica

C<sub>17</sub> = 2200 pf, ceramic disc

C<sub>18</sub> C<sub>19</sub> = 820 pf, mica

C<sub>22</sub> C<sub>23</sub> = 50  $\mu$ f, electrolytic, 3 v.

C<sub>24</sub> C<sub>25</sub> = 0.01  $\mu$ f, mica

C<sub>26</sub> C<sub>28</sub> = 10  $\mu$ f, electrolytic, 12 v.

C<sub>27</sub> = 100  $\mu$ f, electrolytic, 12 v.

CR<sub>1</sub> CR<sub>2</sub> CR<sub>3</sub> = 1N295

L<sub>1</sub> L<sub>8</sub> L<sub>9</sub> = 33-kc trap, variable inductor, General Instrument No. E2741173BX, or equivalent

L<sub>2</sub> L<sub>3</sub> = 19-kc trap, variable inductor, General Instrument No. E2741173AX, or equivalent

L<sub>4</sub> = 100 mh

L<sub>5</sub> = 10 mh

L<sub>6</sub> L<sub>7</sub> = 25 mh

R<sub>1</sub> = 24000 ohms, 0.5 watt

R<sub>2</sub> R<sub>18</sub> = 3900 ohms, 0.5 watt

R<sub>3</sub> R<sub>4</sub> R<sub>15</sub> R<sub>19</sub> R<sub>21</sub> R<sub>22</sub> R<sub>32</sub> R<sub>33</sub>

R<sub>37</sub> = 4700 ohms, 0.5 watt

R<sub>5</sub> = 330 ohms, 0.5 watt

R<sub>6</sub> = 1500 ohms, 0.5 watt

R<sub>7</sub> = 10000 ohms, 0.5 watt

R<sub>8</sub> R<sub>30</sub> R<sub>31</sub> = 5600 ohms, 0.5 watt

R<sub>9</sub> = 68000 ohms, 0.5 watt

R<sub>10</sub> R<sub>32</sub> R<sub>33</sub> = 1000 ohms, 0.5 watt

R<sub>11</sub> = 1200 ohms, 0.5 watt

R<sub>12</sub> R<sub>28</sub> R<sub>29</sub> = 47000 ohms, 0.5 watt

R<sub>13</sub> = potentiometer, 10000 ohms, separation control

R<sub>14</sub> = 1800 ohms, 0.5 watt

R<sub>16</sub> = 43000 ohms, 0.5 watt

R<sub>17</sub> = 560 ohms, 0.5 watt

R<sub>20</sub> = potentiometer, 500 ohms, sideband-level control

R<sub>24</sub> R<sub>38</sub> = 75000 ohms, 0.5 watt

R<sub>25</sub> R<sub>27</sub> = 2200 ohms, 0.5 watt

R<sub>26</sub> R<sub>35</sub> = 47 ohms, 0.5 watt

R<sub>29</sub> = 5600 ohms, 0.5 watt

R<sub>34</sub> R<sub>35</sub> = 47 ohms, 0.5 watt

## 11-13

## STEREO AMPLIFIER

Output 3 Watts per Channel

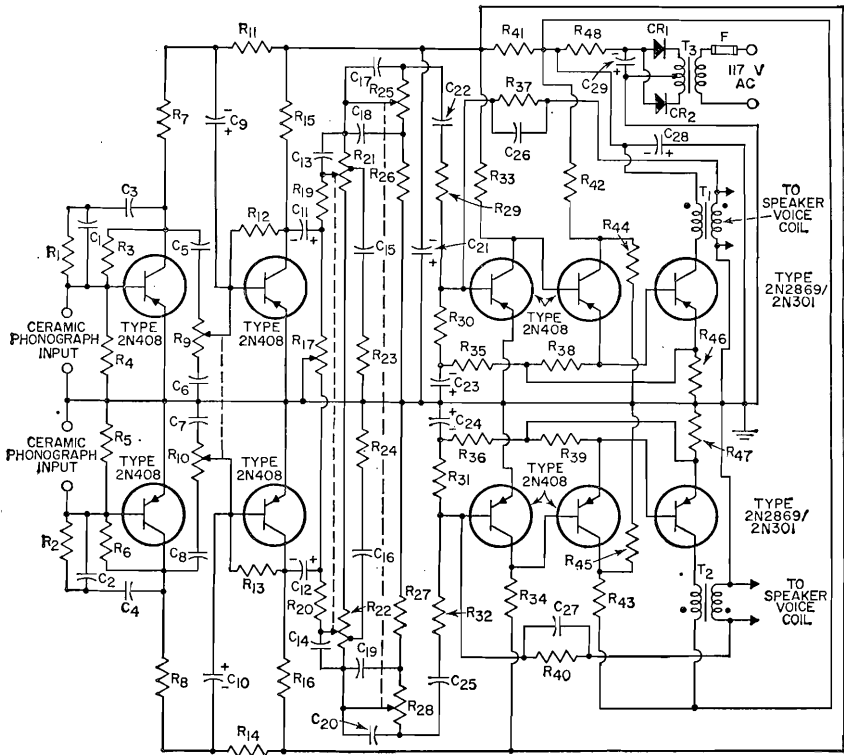

$C_1 C_2 C_3 C_4 = 0.02 \mu\text{f}$ , miniature, 100 v.  
 $C_5 C_6 C_7 C_8 = 0.1 \mu\text{f}$ , miniature, 100 v.  
 $C_9 C_{10} = 0.5 \mu\text{f}$ , miniature, 100 v.  
 $C_{11} C_{12} = 6 \mu\text{f}$ , electrolytic, 6 v.  
 $C_{13} C_{14} = 10 \mu\text{f}$ , electrolytic, 6 v.  
 $C_{15} C_{16} C_{17} C_{18} C_{19} = 1 \mu\text{f}$ , miniature, 100 v.  
 $C_{20} C_{21} = 1000 \mu\text{f}$ , electrolytic, 10 v.  
 $C_{22} C_{23} = 2.2 \mu\text{f}$ , ceramic disc, 3 v.  
 $C_{24} C_{25} = 100 \mu\text{f}$ , electrolytic, 3 v.  
 $C_{26} C_{27} = 12 \text{ pf}$ , ceramic disc, 1000 v.  
 $C_{28} C_{29} = 1000 \mu\text{f}$ , electrolytic, 15 v.

$C_{30} = 1000 \mu\text{f}$ , electrolytic, 25 v.  
 $CR_1 CR_2 = 1N2859$   
 $F = \text{Fuse}$ ,  $\frac{3}{4}$  ampere, "slow-blo"  
 $R_1 R_2 = 3300 \text{ ohms}$ , 0.5 watt  
 $R_3 R_8 = 220000 \text{ ohms}$ , 0.5 watt  
 $R_4 R_5 = 10000 \text{ ohms}$ , 0.5 watt  
 $R_7 R_9 = 1200 \text{ ohms}$ , 0.5 watt  
 $R_{10} = \text{treble-control dual potentiometer}$ , 3000 ohms  
 $R_{11} R_{14} = 2200 \text{ ohms}$ , 0.5 watt  
 $R_{12} R_{13} = 56000 \text{ ohms}$ , 0.5 watt  
 $R_{15} R_{16} = 1500 \text{ ohms}$ , 0.5 watt  
 $R_{17} = \text{balance potentiometer}$ , 2500 ohms  
 $R_{19} R_{20} = 180 \text{ ohms}$ , 0.5 watt  
 $R_{21} R_{22} = \text{loudness-control dual potentiometer}$ , 10000 ohms tapped down 3000 ohms  
 $R_{23} R_{24} R_{26} R_{27} = 330 \text{ ohms}$ , 0.5 watt

$R_{25} R_{28} = \text{bass-control dual potentiometer}$ , 5000 ohms  
 $R_{29} R_{32} = 2200 \text{ ohms}$ , 0.5 watt  
 $R_{30} R_{31} = 1800 \text{ ohms}$ , 0.5 watt  
 $R_{33} R_{34} = 6800 \text{ ohms}$ , 0.5 watt  
 $R_{35} R_{36} = 470 \text{ ohms}$ , 0.5 watt  
 $R_{37} R_{40} = 820000 \text{ ohms}$ , 0.5 watt  
 $R_{38} R_{39} = 51 \text{ ohms}$ , 0.5 watt  
 $R_{41} = 390 \text{ ohms}$ , 0.5 watt  
 $R_{42} R_{43} = 220 \text{ ohms}$ , 1 watt  
 $R_{44} R_{45} = 68 \text{ ohms}$ , 0.5 watt  
 $R_{46} R_{47} = 0.27 \text{ ohm}$ , 0.5 watt  
 $R_{48} = 7 \text{ ohms}$ , 10 watts  
 $T_1 T_2 = \text{output transformer}$ , 25 ohms to 4 ohms at 400 cps; Mid-West Coil and Transformer 20A124 or equiv.  
 $T_3 = \text{power transformer}$ , 117 v. to 48 v., center-tapped (24 v. per winding); Mid-West Coil and Transformer 20P21 or equivalent.

## 11-14

## HIGH-QUALITY STEREO AMPLIFIER

Output 15 Watts per Channel

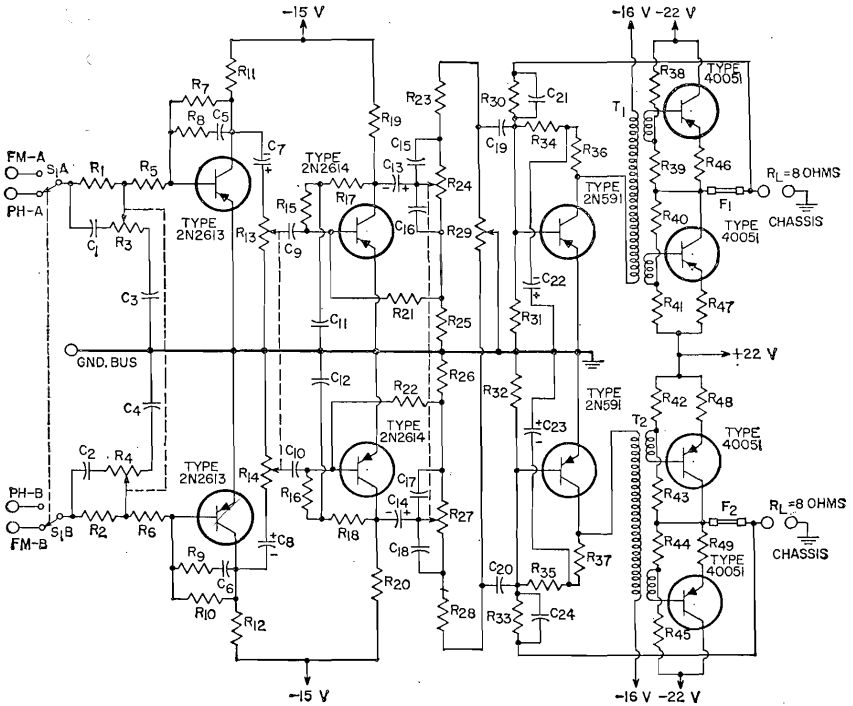

C<sub>1</sub>, C<sub>2</sub> = 180 pf, ceramic  
 C<sub>3</sub>, C<sub>4</sub>, C<sub>5</sub>, C<sub>6</sub> = 1800 pf, ceramic  
 C<sub>7</sub>, C<sub>8</sub> = 2 μf, electrolytic, 10 v.  
 C<sub>9</sub>, C<sub>10</sub>, C<sub>11</sub>, C<sub>12</sub>, C<sub>19</sub>, C<sub>20</sub> = 5 μf, electrolytic, 3 v.  
 C<sub>13</sub>, C<sub>14</sub> = 5 μf, electrolytic, 3 v.  
 C<sub>15</sub>, C<sub>18</sub> = 0.5 μf, ceramic  
 C<sub>16</sub>, C<sub>17</sub> = 4 μf, mylar  
 C<sub>21</sub>, C<sub>24</sub> = 47 pf, ceramic  
 C<sub>22</sub>, C<sub>23</sub> = 50 μf, electrolytic, 3 v.  
 F<sub>1</sub>, F<sub>2</sub> = fuse, 3 amperes  
 R<sub>1</sub>, R<sub>2</sub>, R<sub>7</sub>, R<sub>10</sub> = 1 megohm, 0.5 watt  
 R<sub>3</sub>, R<sub>4</sub> = treble control, dual potentiometers, 3 megohms, 0.5 watt, audio taper  
 R<sub>6</sub>, R<sub>8</sub> = 0.1 megohm, 0.5 watt

R<sub>6</sub>, R<sub>9</sub> = 0.22 megohm, 0.5 watt  
 R<sub>11</sub>, R<sub>12</sub> = 4700 ohms, 0.5 watt  
 R<sub>13</sub>, R<sub>14</sub> = loudness control, dual potentiometers, 25000 ohms, 0.5 watt, linear taper  
 R<sub>15</sub>, R<sub>16</sub> = 27000 ohms, 0.5 watt  
 R<sub>17</sub>, R<sub>18</sub> = 33000 ohms, 0.5 watt  
 R<sub>19</sub>, R<sub>20</sub> = 1000 ohms, 0.5 watt  
 R<sub>21</sub>, R<sub>22</sub> = 10000 ohms, 0.5 watt  
 R<sub>23</sub>, R<sub>28</sub> = 270 ohms, 0.5 watt  
 R<sub>24</sub>, R<sub>27</sub> = bass control, dual potentiometers, 5000 ohms, 0.5 watt, audio taper  
 R<sub>25</sub>, R<sub>26</sub> = 39 ohms, 0.5 watt

R<sub>29</sub> = balance control, potentiometer, 5000 ohms, 0.5 watt, S taper  
 R<sub>30</sub>, R<sub>33</sub> = 0.12 megohm, 0.5 watt  
 R<sub>31</sub>, R<sub>32</sub> = 1500 ohms, 0.5 watt  
 R<sub>34</sub>, R<sub>35</sub> = 12000 ohms, 0.5 watt  
 R<sub>36</sub>, R<sub>37</sub> = 15000 ohms, 0.5 watt  
 R<sub>38</sub>, R<sub>40</sub>, R<sub>43</sub>, R<sub>45</sub> = 5600 ohms, 1 watt  
 R<sub>39</sub>, R<sub>44</sub> = 3.9 ohms, 0.5 watt  
 R<sub>46</sub>, R<sub>47</sub>, R<sub>48</sub>, R<sub>49</sub> = 0.27 ohm, 0.5 watt  
 S<sub>1</sub> = selector switch, double-pole, double-throw  
 T<sub>1</sub>, T<sub>2</sub> = driver transformers, Columbus Process No. X7602, Better Coil and Transformer No. 99A4, or equivalent

11-15 POWER SUPPLY FOR AMATEUR TRANSMITTER

600 Volts; 300 Volts; Total Current 330 Milliamperes (Intermittent Duty)

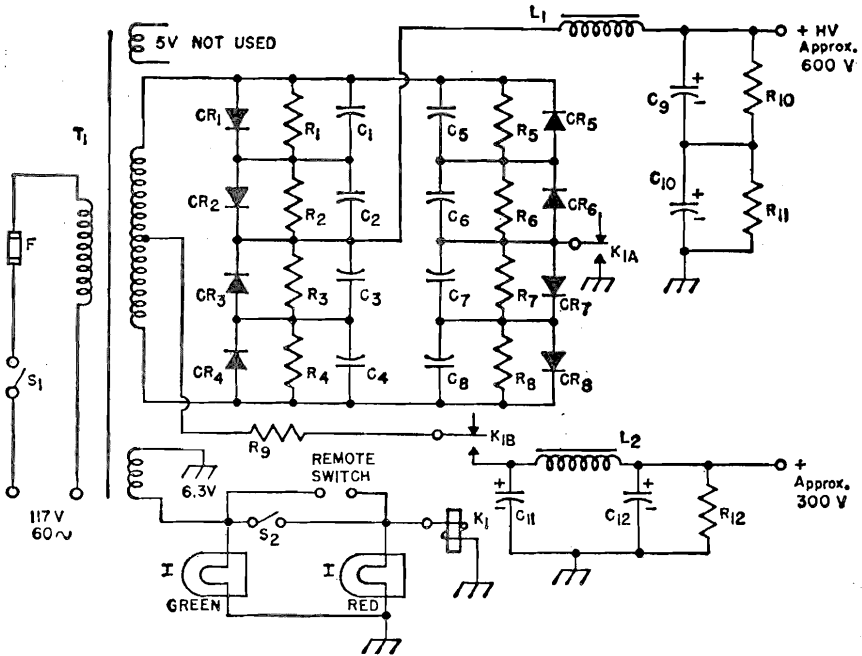

$C_1 C_2 C_3 C_4 C_5 C_6 C_7 C_8 =$   
 0.001  $\mu$ f, ceramic disc,  
 1000 v.  
 $C_9 C_{10} C_{11} C_{12} =$  40  $\mu$ f, elec-  
 trolytic, 450 v.  
 $CR_1 CR_2 CR_3 CR_4 CR_5 CR_6$   
 $CR_7 CR_8 =$  RCA-1N2864  
 F = Fuse, 5 amperes  
 I = indicator lamp

$K_1 =$  relay; Potter and  
 Brumfield KA11AY or  
 equiv.  
 $L_1 =$  2.8 henries, 300 ma;  
 Stancor C-2334 or equiv.  
 $L_2 =$  4 henries, 175 ma;  
 Stancor C-1410 or equiv.  
 $R_1 R_2 R_3 R_4 R_5 R_6 R_7 R_8 =$   
 470 k, 0.5 watt

$R_9 =$  47 ohms, 1 watt  
 $R_{10} R_{11} =$  15000 ohms, 10  
 watts  
 $R_{12} =$  47000 ohms, 2 watts  
 $S_1 S_2 =$  toggle switch, single-  
 pole single-throw  
 T = power transformer;  
 Stancor P-8166 or equiv.

11-16

## 27-Mc CITIZENS-BAND TRANSCEIVER

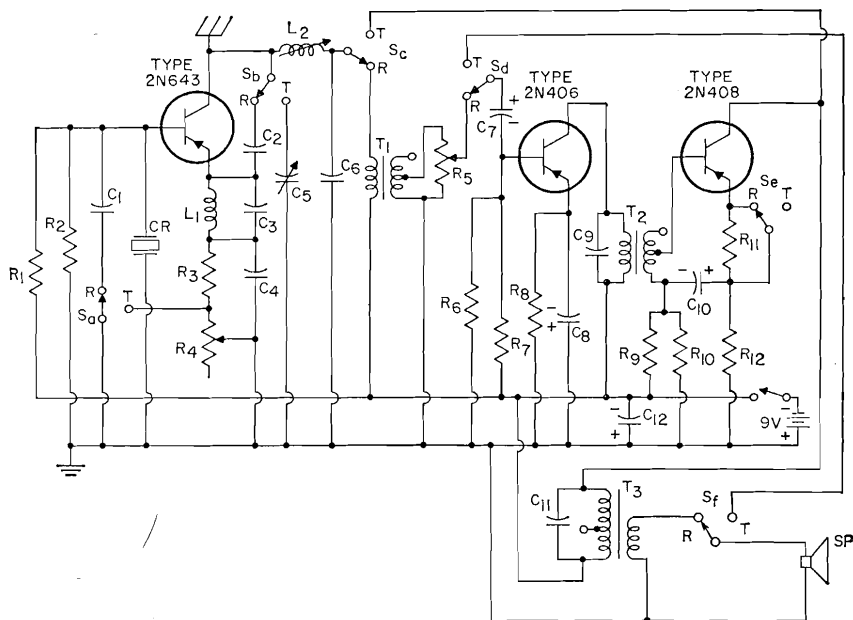

$C_1$   $C_6$   $C_8$  = 0.001  $\mu$ f, ceramic disc

$C_2$   $C_3$  = 27 pf, mica

$C_4$  = 0.02  $\mu$ f, ceramic disc

$C_5$  = 3-35 pf, trimmer

$C_7$  = 10  $\mu$ f, electrolytic, 3 v.

$C_8$   $C_{10}$  = 30  $\mu$ f, electrolytic, 3 v.

$C_{11}$  = 0.2  $\mu$ f, ceramic disc

$C_{12}$  = 200  $\mu$ f, electrolytic, 10 v.

CR = crystal, 27.12 Mc

(series resonant mode)

$L_1$  = 25  $\mu$ h, radio-frequency choke

$L_2$  = 9 turns No. 24 enam. close-wound on  $\frac{1}{4}$ -inch form, ferrite slug

$R_1$  = 2200 ohms, 0.5 watt

$R_2$  = 2200 ohms, 0.5 watt

$R_3$  = 240 ohms, 0.5 watt

$R_4$  = regeneration-control potentiometer, 1000 ohms

$R_5$  = volume-control potentiometer, 5000 ohms

$R_6$  = 6800 ohms, 0.5 watt

$R_7$  = 56000 ohms, 0.5 watt

$R_8$  = 1000 ohms, 0.5 watt

$R_9$  = 10000 ohms, 0.5 watt

$R_{10}$  = 560 ohms, 0.5 watt

$R_{11}$  = 15 ohms, 0.5 watt

$R_{12}$  = 27 ohms, 0.5 watt

S = receive-transmit switch, six-pole two-position

Sp = speaker, 14-ohm voice coil

$T_1$  = transformer; primary 10000 ohms; secondary 1000 ohms, center-tapped (one-half secondary used)

$T_2$  = transformer; primary 20000 ohms; secondary 800 ohms, center-tapped (one-half secondary used)

$T_3$  = transformer; primary 650 ohms, center-tapped; secondary 16 ohms

11-17 27-Mc, 5-WATT CITIZENS-BAND TRANSMITTER

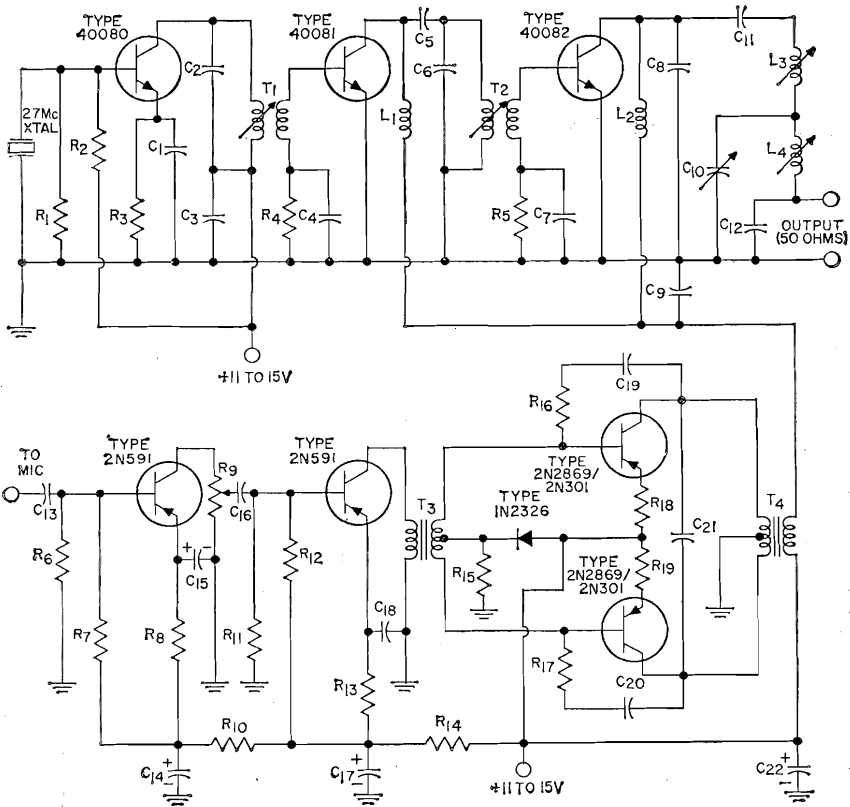

- C<sub>1</sub> = 75 pf, ceramic
- C<sub>2</sub> = 30 pf, ceramic
- C<sub>3</sub>, C<sub>4</sub>, C<sub>7</sub> = 0.01  $\mu$ f, ceramic
- C<sub>5</sub> = 47 pf, ceramic
- C<sub>6</sub> = 51 pf, mica
- C<sub>8</sub> = 24 pf, mica
- C<sub>9</sub> = 0.01  $\mu$ f, ceramic
- C<sub>10</sub> = variable capacitor, 90 to 400 pf (ARCO 429, or equiv.)
- C<sub>11</sub> = 100 pf, ceramic
- C<sub>12</sub> = 220 pf, ceramic
- C<sub>13</sub> = 5  $\mu$ f, ceramic
- C<sub>14</sub>, C<sub>17</sub> = 50  $\mu$ f, electrolytic, 25 v.
- C<sub>15</sub> = 10  $\mu$ f, electrolytic, 15 v.
- C<sub>18</sub>, C<sub>19</sub> = 10  $\mu$ f, ceramic
- C<sub>19</sub>, C<sub>20</sub> = 0.2  $\mu$ f, ceramic
- C<sub>21</sub> = 0.1  $\mu$ f, ceramic
- C<sub>22</sub> = 500  $\mu$ f, electrolytic, 15 v.
- L<sub>1</sub>, L<sub>2</sub> = rf choke, 15  $\mu$ f (Miller 4624, or equiv.)

- L<sub>3</sub> = variable inductor (0.75 to 1.2  $\mu$ h); 11 turns No. 22 wire wound on  $\frac{1}{4}$ -inch CTC coil form having a "green dot" core; Q = 120
- L<sub>4</sub> = variable inductor (0.5 to 0.9  $\mu$ h); 7 turns No. 22 wire wound on  $\frac{1}{4}$ -inch CTC coil form having a "green dot" core; Q = 140
- R<sub>1</sub> = 510 ohms, 0.5 watt
- R<sub>2</sub>, R<sub>12</sub> = 5100 ohms, 0.5 watt
- R<sub>3</sub> = 51 ohms, 0.5 watt
- R<sub>4</sub> = 120 ohms, 0.5 watt
- R<sub>5</sub> = 47 ohms, 0.5 watt
- R<sub>6</sub> = 0.1 megohm, 0.5 watt
- R<sub>7</sub> = 10000 ohms, 0.5 watt
- R<sub>8</sub> = 2000 ohms, 0.5 watt
- R<sub>9</sub> = potentiometer, 10000 ohms
- R<sub>10</sub> = 3600 ohms, 0.5 watt
- R<sub>11</sub> = 15000 ohms, 0.5 watt
- R<sub>13</sub> = 1000 ohms, 0.5 watt
- R<sub>14</sub> = 1200 ohms, 0.5 watt
- R<sub>15</sub> = 240 ohms, 0.5 watt

- R<sub>16</sub>, R<sub>17</sub> = 2700 ohms, 0.5 watt
- R<sub>18</sub>, R<sub>19</sub> = 1.5 ohms, 0.5 watt
- T<sub>1</sub> = rf transformer; primary 14 turns, secondary 3 turns of No. 22 wire wound on  $\frac{1}{4}$ -inch CTC coil form having a "green dot" core; slug-tuned (0.75 to 1.2  $\mu$ h); Q = 100
- T<sub>2</sub> = rf transformer; primary 14 turns, secondary 2- $\frac{3}{4}$  turns of No. 22 wire wound on  $\frac{1}{4}$ -inch CTC coil form having a "green dot" core; slug-tuned (0.75 to 1.2  $\mu$ h); Q = 100
- T<sub>3</sub> = transformer; primary: 2500 ohms; secondary 200 ohms center-tapped; Microtran SMT 17-SB, or equiv.
- T<sub>4</sub> = transformer; primary: 100 ohms center-tapped; secondary: 30 ohms

11-18

VIDEO AMPLIFIER

High Input Impedance, Bandwidth 7.5 Mc, Gain 75

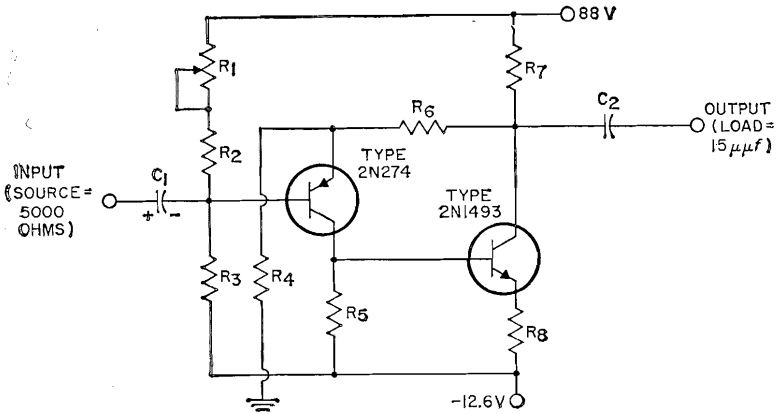

$C_1 = 10 \mu\text{f}$ , electrolytic,  
15 v.  
 $C_2 = 0.1 \mu\text{f}$ , paper, 100 v.  
 $R_1 =$  potentiometer, 25000  
ohms (adjust for 40 v.

between collector of  
2N1493 and ground)  
 $R_2 = 50000$  ohms, 1 watt  
 $R_3, R_8 = 10000$  ohms,  
0.5 watt

$R_4 = 100$  ohms, 0.5 watt  
 $R_6 = 510$  ohms, 0.5 watt  
 $R_7 = 2000$  ohms, 1 watt  
 $R_8 = 20$  ohms, 0.5 watt

11-19

70-Mc POWER AMPLIFIER

Output 0.5 Watt

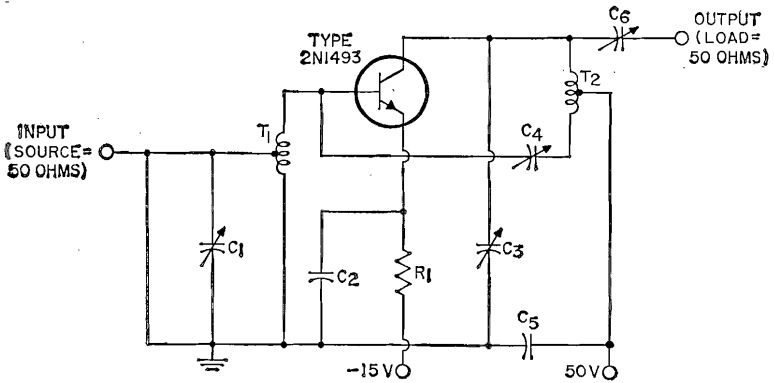

$C_1, C_3, C_4, C_6 = 3-20$  pf,  
ceramic trimmer  
 $C_2, C_5 = 0.01 \mu\text{f}$ , 100 v.  
 $R_1 = 1000$  ohms, 2 watts

$T_1 = 8$  turns No. 24 enam.  
on General Ceramic Corp.  
F-303 toroid of Q material,  
tapped at 7 turns from  
ground

$T_2 = 8$  turns of No. 24 enam.  
wound on CTC  $\frac{3}{8}$ -inch  
ceramic coil form (no  
slug used), tapped at 2.5  
turns

## 11-20 "FRONT END" FOR 450-Mc SUPERHETERODYNE RECEIVER

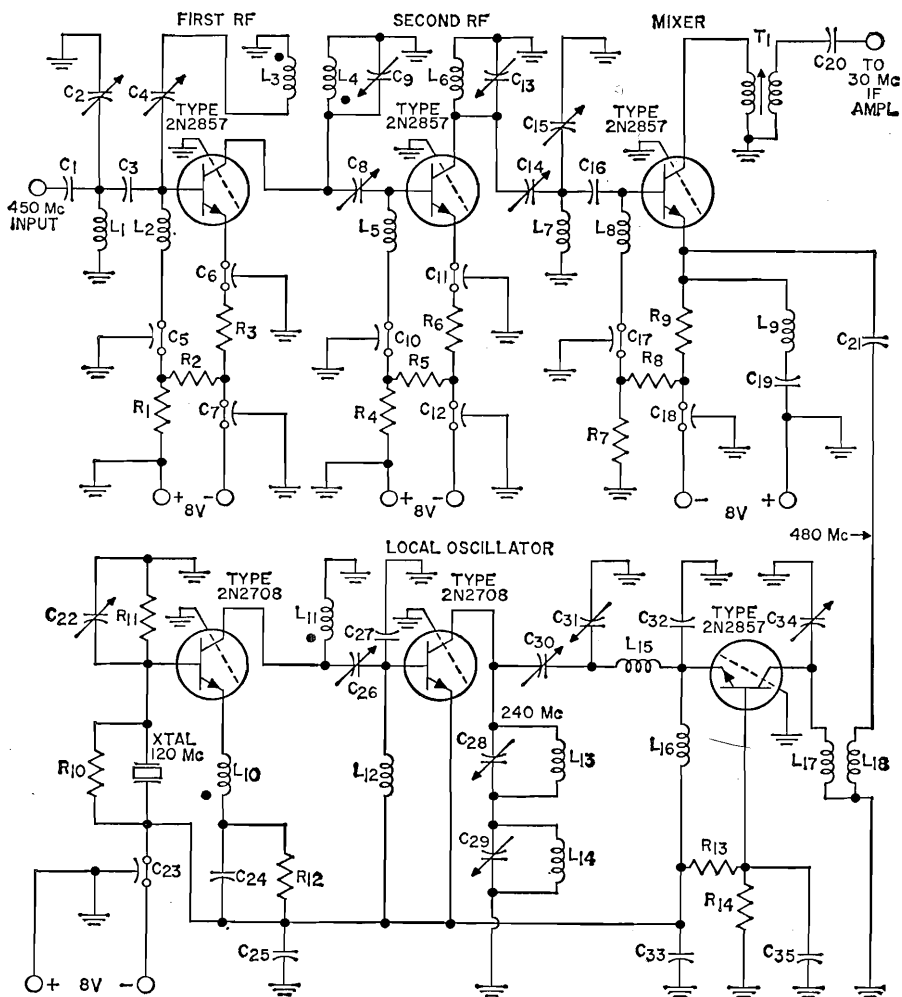

C<sub>1</sub>, C<sub>3</sub>, C<sub>13</sub>, C<sub>19</sub> = 50 pf, ceramic disc  
 C<sub>2</sub>, C<sub>9</sub>, C<sub>15</sub>, C<sub>34</sub> = trimmer; 0.8 to 8 pf; JFD type VC20G, or equiv.  
 C<sub>4</sub>, C<sub>8</sub>, C<sub>14</sub> = trimmer; 0.3 to 5 pf; tubular ceramic  
 C<sub>5</sub>, C<sub>6</sub>, C<sub>10</sub>, C<sub>11</sub>, C<sub>17</sub> = 500 pf, ceramic feedthrough  
 C<sub>7</sub>, C<sub>12</sub>, C<sub>18</sub> = 1000 pf, ceramic feedthrough  
 C<sub>19</sub> = 75 pf, ceramic disc  
 C<sub>20</sub>, C<sub>24</sub>, C<sub>25</sub>, C<sub>35</sub> = 0.005  $\mu$ f, ceramic disc

C<sub>21</sub> = 470 pf, ceramic disc  
 C<sub>22</sub> = trimmer, 3 to 12 pf, tubular ceramic  
 C<sub>23</sub> = 0.001  $\mu$ f, ceramic feedthrough  
 C<sub>26</sub>, C<sub>28</sub>, C<sub>30</sub> = trimmer; 1 to 12 pf; JFD type 57G, or equiv.  
 C<sub>27</sub> = 24 pf, ceramic disc  
 C<sub>29</sub> = trimmer; 2 to 25 pf; JFD type VC24GY, or equiv.  
 C<sub>31</sub> = trimmer; 1 to 4 pf; JFD type VC21G, or

equiv.  
 C<sub>32</sub> = 0.001  $\mu$ f, ceramic disc  
 L<sub>1</sub>, L<sub>7</sub> = silver-plated bar stock; length, 2.8 inches; diameter,  $\frac{1}{4}$  inch  
 L<sub>3</sub> = one-half turn of No. 16 solid copper wire, located  $\frac{1}{4}$  inch from and parallel to L<sub>4</sub>  
 L<sub>4</sub>, L<sub>6</sub> = silver-plated bar stock; length, 3 inches; diameter,  $\frac{1}{4}$  inch  
 L<sub>5</sub>, L<sub>8</sub>, L<sub>9</sub> = 0.22  $\mu$ h; rf choke; J. W. Miller Type 9320-02, or equiv.



## 11-21

## 30-Mc IF AMPLIFIER

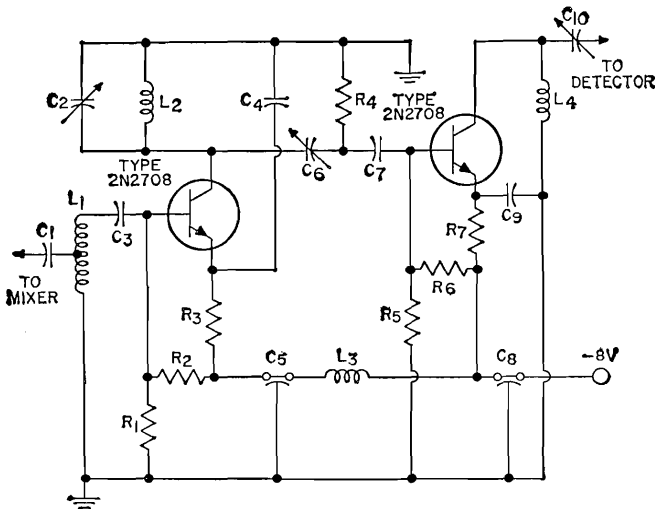

$C_1, C_3, C_4, C_7, C_9 = 0.05 \mu\text{f}$ , ceramic disc  
 $C_2 = \text{trimmer, } 0.8 \text{ to } 8 \text{ pf}$ , JFD type VC20G, or equiv.  
 $C_5, C_8 = 2000 \text{ pf}$ , ceramic feedthrough  
 $C_6 = \text{trimmer, } 6 \text{ to } 8 \text{ pf}$ , tubular ceramic

$C_{10} = \text{trimmer, } 2 \text{ to } 25 \text{ pf}$ ; JFD type VC24GY, or equiv.

$L_1 = 3 \mu\text{h}$ ; tapped rf coil; ratio of number of turns in over-all coil to the number in section between tap and ground, 1.5 to 1

$L_2, L_4 = 2 \mu\text{h}$ , rf coil  
 $L_3 = 10 \mu\text{h}$ , rf choke  
 $R_1, R_5 = 18000 \text{ ohms}$ , 0.5 watt  
 $R_2, R_6 = 7500 \text{ ohms}$ , 0.5 watt  
 $R_3, R_7 = 1000 \text{ ohms}$ , 0.5 watt  
 $R_4 = 110 \text{ ohms}$ , 0.5 watt

## 11-20 "FRONT END" FOR 450-Mc SUPERHETERODYNE RECEIVER (cont'd)

$L_{10}, L_{11} = 5 \text{ turns}$  of No. 22 wire, 0.25-inch inner diameter, coupled on same coil form  
 $L_{12} = 1 \mu\text{h}$ , rf choke  
 $L_{13} = 1.1 \mu\text{h}$ , rf coil  
 $L_{14} = 6 \text{ turns}$  of No. 22 wire; length,  $\frac{3}{4}$  inch; inner diameter,  $\frac{3}{16}$  inch  
 $L_{15} = 5 \text{ turns}$  of No. 22 wire; length,  $\frac{3}{8}$  inch; inner diameter,  $\frac{1}{2}$  inch  
 $L_{16} = 1 \mu\text{h}$ , rf choke

$L_{17} = \text{silver-plated bar stock}$ ; length, 2 inches; diameter  $\frac{1}{4}$  inch  
 $L_{18} = \text{silver-plate brass strip}$ ; length, 1 inch; width,  $\frac{1}{4}$  inch; located  $\frac{1}{16}$  inch from and parallel to  $L_{17}$   
 $R_1, R_4, R_7 = 6800 \text{ ohms}$ , 0.5 watt  
 $R_2, R_5, R_8 = 2700 \text{ ohms}$ , 0.5 watt  
 $R_3, R_6, R_9 = 1000 \text{ ohms}$ , 0.5 watt

$R_{10} = 4.7 \text{ ohms}$ , 0.5 watt  
 $R_{11} = 51000 \text{ ohms}$ , 0.5 watt  
 $R_{12} = 510 \text{ ohms}$ , 0.5 watt  
 $R_{13} = 15000 \text{ ohms}$ , 0.5 watt  
 $R_{14} = 39000 \text{ ohms}$ , 0.5 watt  
 $T_1 = \text{rf transformer}$  (30 Mc); 9  $\mu\text{h}$ ; primary-to-secondary turns ratio, 30 to 1; primary, 26 turns of No. 22 wire wound on J. W. Miller type 4500 coil form  
 $XTAL = 120\text{-Mc oscillator crystal}$

## 11-22

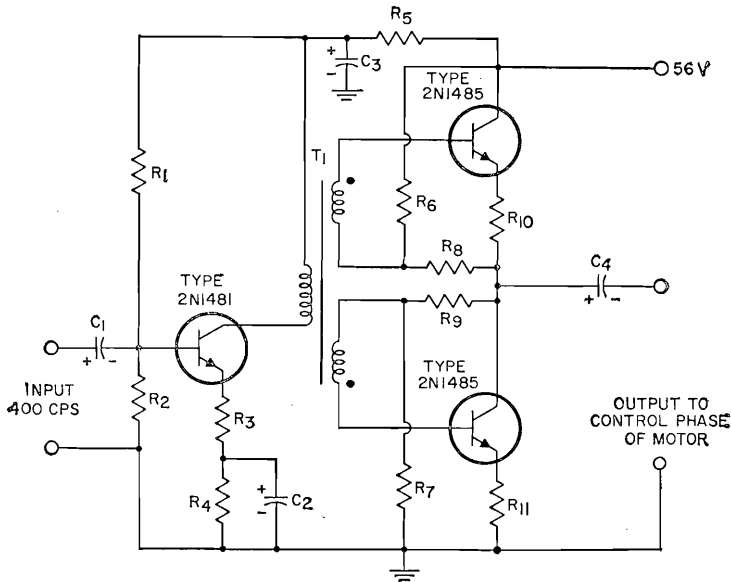
SERVO AMPLIFIER  
Output 6 Watts

$C_1 = 10 \mu\text{f}$ , electrolytic,  
15 v.  
 $C_2 = 47 \mu\text{f}$ , electrolytic,  
15 v.  
 $C_3 = 20 \mu\text{f}$ , electrolytic,  
50 v.  
 $C_4 = 500 \mu\text{f}$ , electrolytic,  
50 v.

$R_1 = 68000$  ohms, 0.5 watt  
 $R_2 = 5600$  ohms, 0.5 watt  
 $R_3 = 56$  ohms, 0.5 watt  
 $R_4 = 560$  ohms, 0.5 watt  
 $R_5 = 3300$  ohms, 0.5 watt  
 $R_6, R_8 = 18000$  ohms, 0.5 watt  
 $R_7, R_9 = 400$  ohms, 0.5 watt  
 $R_{10}, R_{11} = 4$  ohms, 1 watt

T = driver transformer; core  
 material 0.014-inch Mag-  
 netic Metals Corp. "Crys-  
 talligned" or equiv.;  
 primary 1500 turns; sec-  
 ondary 450 turns, bifilar  
 wound (each section 225  
 turns)

## 11-23

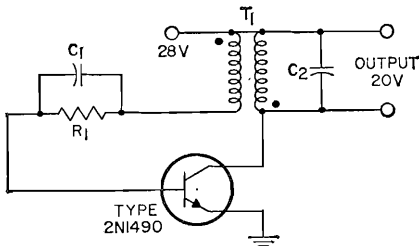
100-Kc POWER OSCILLATOR  
Output 10 Watts

$C_1 = 0.1 \mu\text{f}$ , paper, 50 v.  
 $C_2 = 0.33 \mu\text{f}$ , paper, 100 v.  
 $R_1 = 510$  ohms, 0.5 watt  
 T = rf transformer; air core;  
 collector winding, 19 turns  
 No. 10 enam; base wind-  
 ing, 5 turns No. 22 enam;  
 inside diameter of wind-  
 ings, 0.88 inch; close-  
 wound

11-24

27-Mc CRYSTAL OSCILLATOR

Output 4 mw

- C<sub>1</sub> = 20 pf, ceramic disc, 25 v.
- C<sub>2</sub> C<sub>4</sub> = 0.01 μf, ceramic disc, 25 v.
- C<sub>3</sub> = 22 pf, ceramic disc, 25 v.
- CR = crystal, 27 Mc
- L<sub>1</sub> = 15 turns No. 22 enam., close-wound on CTC LS5 form (powdered-iron slug)
- L<sub>2</sub> = 2 turns No. 18 enam., wound over cold end of L<sub>1</sub>
- R<sub>1</sub> = 9100 ohms, 0.5 watt
- R<sub>2</sub> = 680 ohms, 0.5 watt
- R<sub>3</sub> = 200 ohms, 0.5 watt

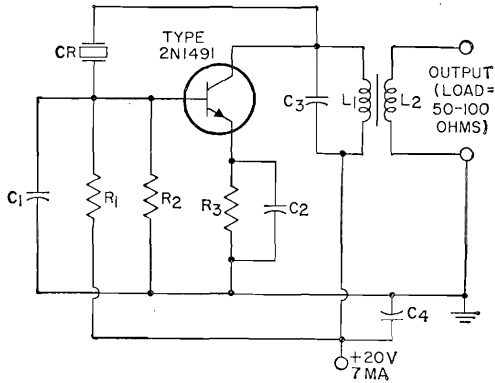

11-25

70-Mc POWER OSCILLATOR

Output 0.5 Watt

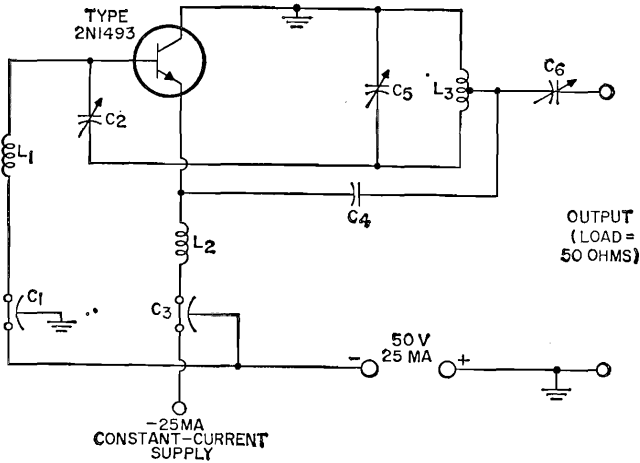

- C<sub>1</sub> C<sub>3</sub> = 1500 pf, feed-through, ceramic
- C<sub>2</sub> C<sub>6</sub> = 7-100 pf, trimmer, ceramic
- C<sub>4</sub> = 0.01 μf, ceramic

- disc, 25 v.
- C<sub>5</sub> = 5-50 pf, trimmer, ceramic
- L<sub>1</sub> L<sub>2</sub> = 10 μh, radio-frequency choke

- L<sub>3</sub> = 3½ turns No. 14 enam., close-wound on ¾-inch diameter, tapped at 2 turns

11-26

250-Mc OSCILLATOR

Output 150 mw

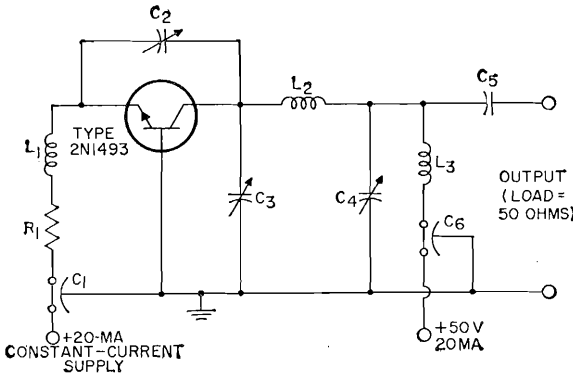

- C<sub>1</sub> C<sub>5</sub> = 1000 pf, feed-through, ceramic
- C<sub>2</sub> = 0.6-5.5 pf, trimmer, ceramic
- C<sub>3</sub> = 3-15 pf, trimmer, ceramic
- C<sub>4</sub> = 4-50 pf, trimmer, ceramic
- C<sub>6</sub> = 0.002 μf, paper, 100 v.
- L<sub>1</sub> L<sub>3</sub> = 0.82 μh, radio-frequency choke
- L<sub>2</sub> = 1 turn No. 14 enam., 1-inch diameter
- R<sub>1</sub> = 400 ohms, 0.5 watt

11-27

DC-TO-DC CONVERTER

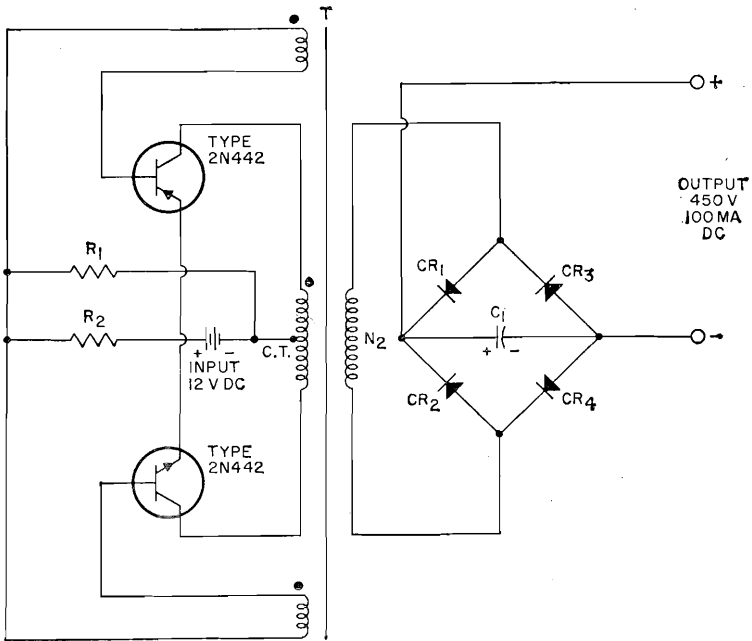

- C<sub>1</sub> = 10 μf, electrolytic 500 v.
- CR<sub>1</sub> CR<sub>2</sub> CR<sub>3</sub> CR<sub>4</sub> = 1N3256 (or 1N3196)
- R<sub>1</sub> = 330 ohms, 2 watts
- R<sub>2</sub> = 5 ohms, 5 watts
- T<sub>1</sub> = transformer; core: one hundred 0.014-inch-thick

E-I laminations of Magnetic Metals Corp. "CrySTALLIGNED 33," or equiv.; primary: 34 turns, bifilar wound, of AWG No. 16 enameled wire, center tapped (each section 17 bifilar turns); feedback

windings: 5 turns each of AWG No. 26 enameled wire; secondary: 640 turns of AWG No. 26 enameled wire; winding order; primary, feedback windings, secondary.

11-28

VOLTAGE REGULATOR, SHUNT TYPE

Regulation 1.5%

CR = reference diode, 27 v.  
 $R_1 = 28$  ohms, 10 watts (includes source resistance of transformers, rectifiers, etc.)  
 $R_2 = 50$  ohms, 0.5 watt

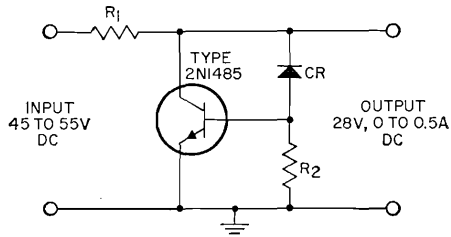

11-29

VOLTAGE REGULATOR, SERIES TYPE

Regulation 2%

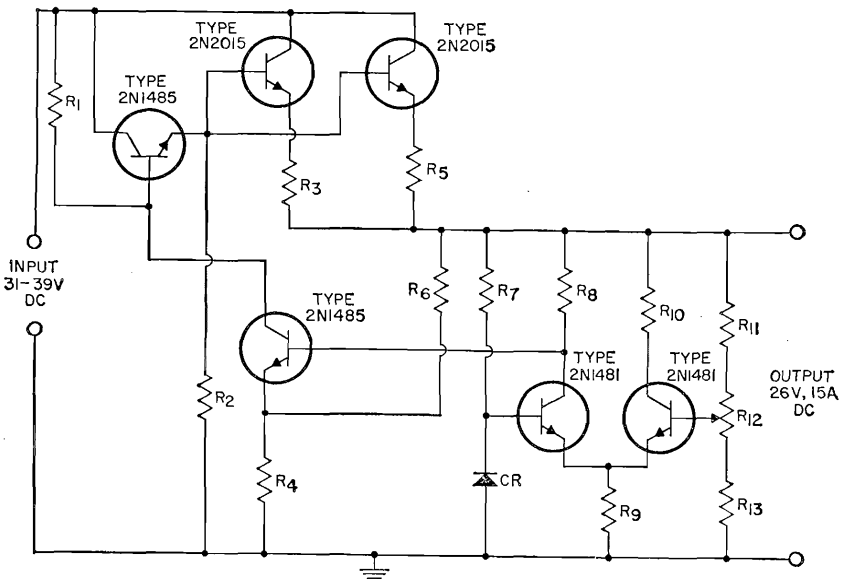

CR = reference diode, 7.5 v., 100 mw.  
 $R_1 = 225$  ohms, 5 watts  
 $R_2 = 10000$  ohms, 0.5 watt  
 $R_3 R_5 = 0.075$  ohm, 5 watts (cut to measure from resistance wire)

$R_4 = 60$  ohms, 4 watts  
 $R_6 = 75$  ohms, 5 watts  
 $R_7 = 2200$  ohms, 0.5 watt  
 $R_8 R_{10} = 500$  ohms, 2 watts  
 $R_9 = 120$  ohms, 2 watts  
 $R_{11} = 820$  ohms, 1 watt  
 $R_{12} =$  potentiometer, 150 ohms, 0.5 watt

$R_{13} = 300$  ohms, 1 watt

NOTE: 2N1485 and 2N2015 transistors must be mounted on heat sink of sufficient size to keep the case temperatures below 100°C.

**11-30 VOLTAGE REGULATOR, SHUNT TYPE**

Regulation 0.5%

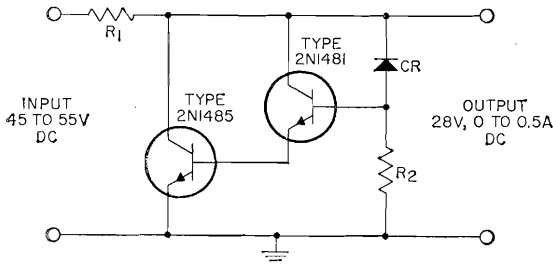

CR = reference diode, 27 v.  
 R<sub>1</sub> = 28 ohms, 10 watts (includes source resistance of transformers, rectifiers, etc.)  
 R<sub>2</sub> = 1000 ohms, 0.5 watt

**11-31 VOLTAGE REGULATOR, SERIES TYPE**

With Adjustable Output

Line Regulation within 1.0%

Load Regulation within 0.5%

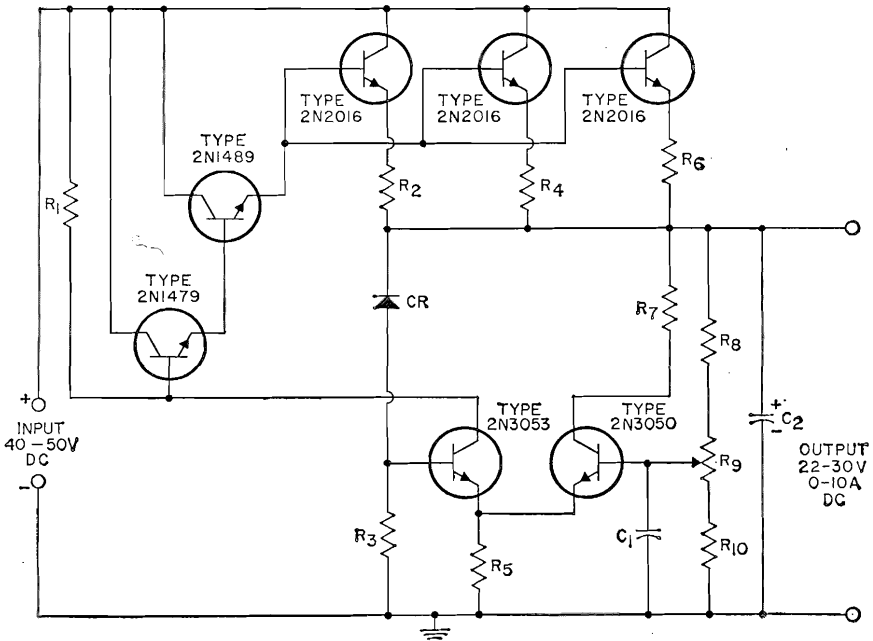

C<sub>1</sub> = 1 μf, paper, 25 v.  
 C<sub>2</sub> = 100 μf, electrolytic, 50 v.  
 CR = reference diode, 12 v.

R<sub>1</sub> = 1200 ohms, 0.5 watt  
 R<sub>2</sub> R<sub>4</sub> R<sub>9</sub> = 0.1 ohm, 0.5 watt  
 R<sub>3</sub> = 2000 ohms, 0.5 watt  
 R<sub>5</sub> = 570 ohms, 0.5 watt

R<sub>7</sub> = 270 ohms, 0.5 watt  
 R<sub>8</sub> R<sub>10</sub> = 1000 ohms, 0.5 watt  
 R<sub>6</sub> = potentiometer, 1000 ohms, 0.5 watt

11-32

**ASTABLE MULTIVIBRATOR**  
(Repetition Rate = 7000 pps)

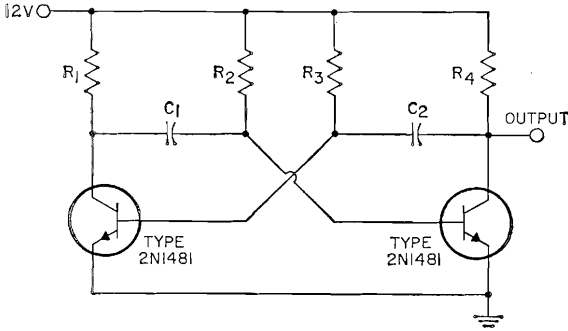

Rep. Rate =  $\frac{1}{2(0.7R_2C_1)}$   
 $C_1 C_2 = 0.01 \mu f$ , paper, 25 v.  
 $R_1 R_4 = 60$  ohms, 5 watts  
 $R_2 R_3 = 1000$  ohms, 0.5 watt

11-33

**MONOSTABLE MULTIVIBRATOR**  
(On-Time Pulse = 70 Milliseconds)

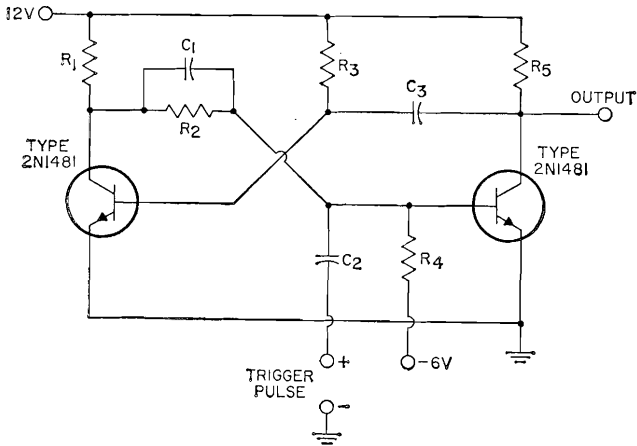

On-time Pulse =  $0.7R_3C_3$   
 $C_1 = 0.005 \mu f$ , paper, 25 v.  
 $C_2 = 0.05 \mu f$ , paper, 25 v.

$C_3 = 0.01 \mu f$ , paper, 25 v.  
 $R_1 R_5 = 60$  ohms, 5 watts  
 $R_2 = 820$  ohms, 0.5 watt

$R_3 = 1000$  ohms, 0.5 watt  
 $R_4 = 5000$  ohms, 0.5 watt

11-34

### BISTABLE MULTIVIBRATOR 1-Mc "Flip-Flop"

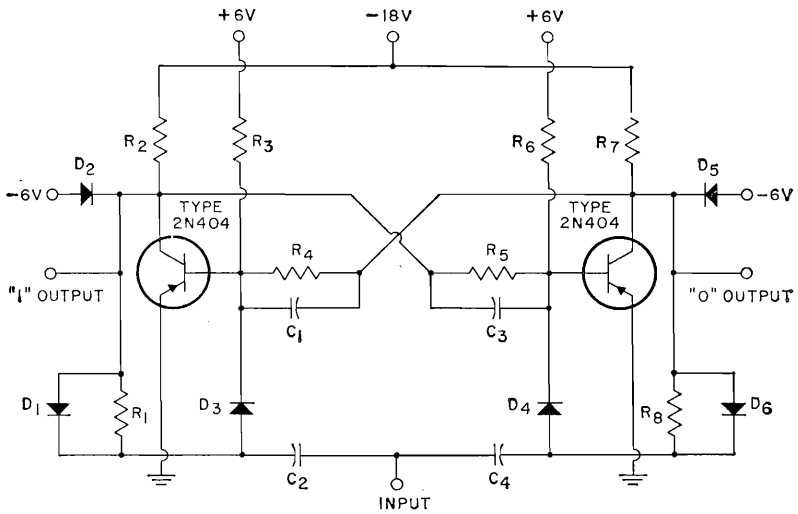

$C_1$   $C_3$  = 180 pf, mica, 24 v.  
 $C_2$   $C_4$  = 430 pf, mica, 24 v.

$D_1$   $D_2$   $D_3$   $D_4$   $D_5$   $D_6$  = diode,  
 1N126  
 $R_1$   $R_8$  = 5100 ohms, 0.5 watt

$R_2$   $R_7$  = 1200 ohms, 0.5 watt  
 $R_3$   $R_6$  = 11000 ohms, 0.5 watt  
 $R_4$   $R_5$  = 2700 ohms, 0.5 watt



11-35

6-VOLT IGNITION SYSTEM

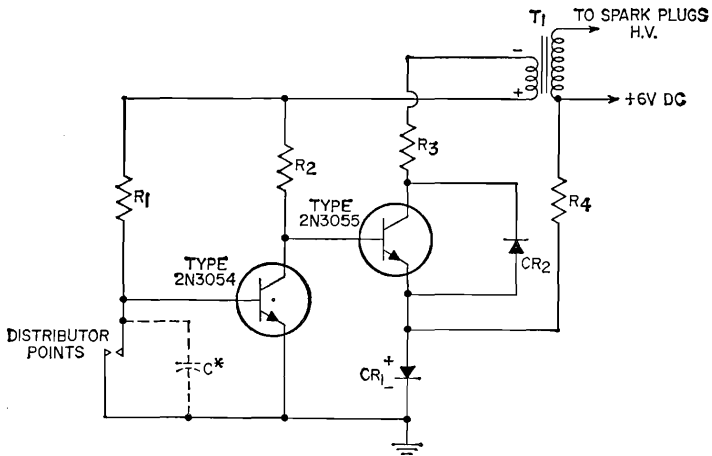

CR<sub>1</sub> = 1N1202A  
 CR<sub>2</sub> = zener diode, 90 volts,  
 50 watts  
 R<sub>1</sub> = 50 ohms, 5 watts  
 R<sub>2</sub> = 2 ohms, 25 watts

R<sub>3</sub> = 0.2 ohms, 25 watts  
 R<sub>4</sub> = 100 ohms, 1 watt  
 T<sub>1</sub> = ignition coil; Mallory  
 Type F-12T, or equiv.  
 \* The capacitor (conden-

ser) normally connected  
 across the distributor  
 points in the automobile  
 may be retained in the  
 circuit.

11-36

12-VOLT IGNITION SYSTEM

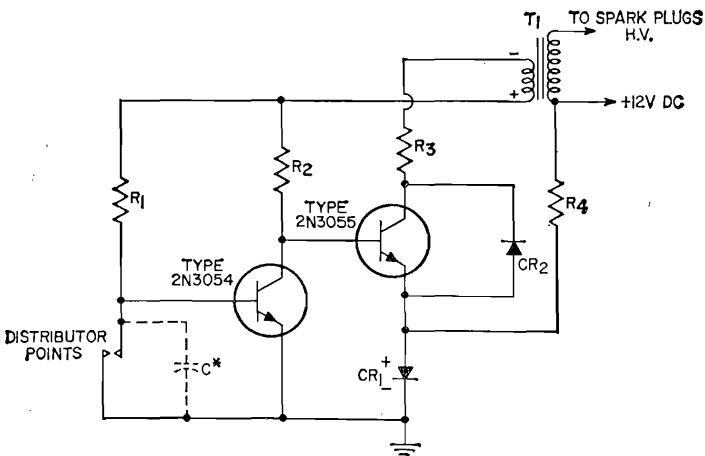

CR<sub>1</sub> = 1N1202A  
 CR<sub>2</sub> = zener diode, 90 volts,  
 50 watts  
 R<sub>1</sub> = 100 ohms, 5 watts  
 R<sub>2</sub> = 7.5 ohms, 25 watts

R<sub>3</sub> = 1.0 ohm, 100 watts  
 R<sub>4</sub> = 200 ohms, 1 watt  
 T<sub>1</sub> = ignition coil; Mallory  
 Type F-12T, or equiv.  
 \* The capacitor (conden-

ser) normally connected  
 across the distributor  
 points in the automobile  
 may be retained in the  
 circuit.

11-37

**VOLTAGE-SENSITIVE SWITCH  
(USED WITH NORMALLY OPEN RELAY)**

Relay energizes when voltage level exceeds a predetermined value

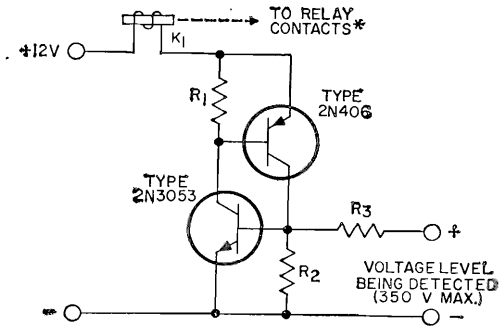

$K_1$  = dc relay; 12-volt, 71-ohm coil; Potter-Brumfield Type PR11DY, or equivalent.  
 $R_1$  = 150 ohms  $\pm$  10%; 0.5 watt

$R_2$  = 470 ohms  $\pm$  10%; 0.5 watt  
 $R_3$  = desired detection-voltage level x 800 ohms

\*Relay-contact connections may be arranged to provide the type of control functions desired.

11-38

**VOLTAGE-SENSITIVE SWITCH  
(USED WITH NORMALLY CLOSED RELAY)**

Relay de-energizes when voltage level exceeds a predetermined value

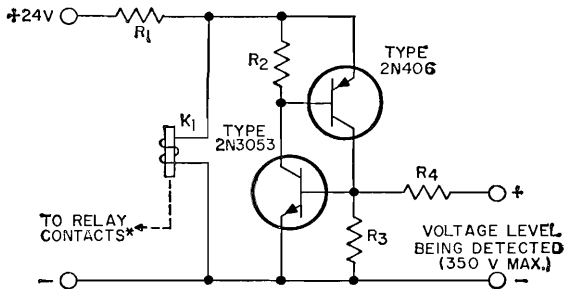

$K$  = dc relay; 12-volt, 71-ohm coil; Potter-Brumfield Type PR11DY, or equivalent  
 $R_1$  = 75 ohms  $\pm$  10%, 10 watts

$R_2$  = 150 ohms  $\pm$  10%, 0.5 watt  
 $R_3$  = 470 ohms  $\pm$  10%, 0.5 watt  
 $R_4$  = desired detection-voltage level x 800 ohms

\*Relay-contact connections may be arranged to provide the type of control functions desired.

11-39

SHIFT REGISTER

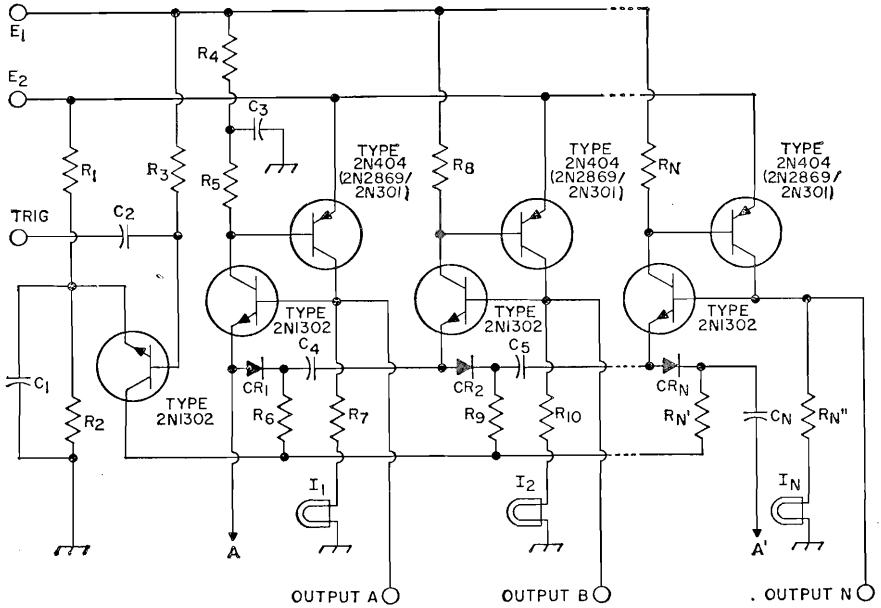

$C_1 = 100 \mu\text{f}$ , electrolytic, 6 v.  
 $C_2, C_4, C_5, C_N = 0.05 \mu\text{f}$  (or  
 0.1  $\mu\text{f}$ ), ceramic, 50 v.  
 $C_3 = 1 \mu\text{f}$  (or 25  $\mu\text{f}$ ), elec-  
 trolytic, 25 v.  
 $CR_1, CR_2, CR_N =$  crystal  
 diode 1N34 (or 1N3754)  
 $I_1, I_2, I_N =$  indicator lamp

No. 49; 2-volt, 60-ma (or  
 No. 1488; 14-volt, 150-ma)  
 $R_1 = 1000$  ohms, 0.5 watt  
 (or 680 ohms, 1 watt)  
 $R_2 = 27$  ohms, 0.5 watt (or  
 12 ohms, 1 watt)  
 $R_3 = 1000$  ohms, 0.5 watt  
 $R_4 = 1000$  ohms, 0.5 watt (or

330 ohms, 0.5 watt)  
 $R_5, R_8, R_{10}, R_N = 2200$  ohms,  
 0.5 watt (or 680 ohms,  
 0.5 watt)  
 $R_6, R_9, R_N' = 560$  ohms, 0.5  
 watt (or 180 ohms, 1 watt)  
 $R_7, R_N'' = 150$  ohms, 1 watt  
 (or 82 ohms, 2 watts)

Notes:

The shift register may use as many stages as desired and may be made regenerative by connecting points A and A'. In addition, the basic circuit can be adapted for operation at many different output-current levels.

The circuit as shown is designed for an output-current level of 40 ma ( $E_1 = 12$  v;  $E_2 = 9$  v). Transistor types and component values shown in parenthesis indicate the changes necessary for operation at an output-current level of 3 amperes ( $E_1 = 27$  v;  $E_2 = 24$  v).

## 11-40

## ELECTRONIC THERMOSTAT

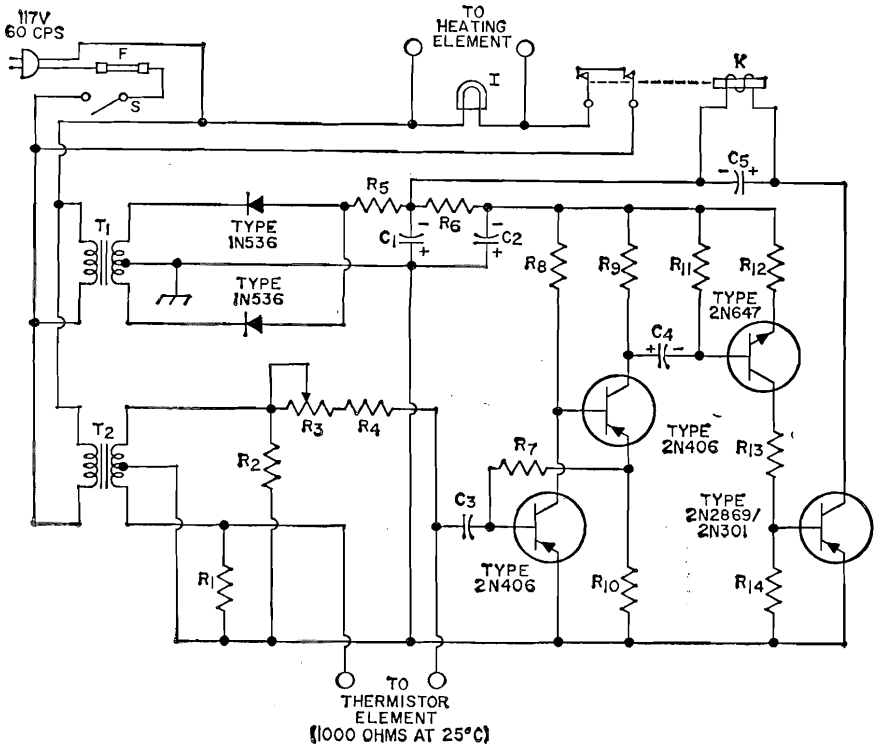

$C_1, C_2 = 1000 \mu\text{f}$ , electrolytic, 25 v.

$C_3 = 2 \mu\text{f}$ , paper, 200 v.

$C_4 = 100 \mu\text{f}$ , electrolytic, 15 v.

$C_5 = 100 \mu\text{f}$ , electrolytic, 25 v.

F = fuse, 3 amp.

I = indicator lamp; 117 v., 6 watts

K = dc relay; single-pole, single-throw, double-break; 12-volt dc coil, 80 ohms minimum resistance; Potter-Brumfield PR3DY or equiv.

$R_1, R_2 = 3000 \text{ ohms} \pm 10\%$ ; 0.5 watt

$R_3 =$  variable resistor, 500 ohms, linear taper, 0.5 watt

$R_4 = 330 \text{ ohms} \pm 10\%$ , 0.5 watt

$R_5, R_{12}, R_{14} = 47 \text{ ohms} \pm 10\%$ , 0.5 watt

$R_6 = 1000 \text{ ohms} \pm 10\%$ , 2 watts

$R_7, R_8 = 1000 \text{ ohms} \pm 10\%$ , 0.5 watt

$R_9 = 12000 \text{ ohms} \pm 10\%$ , 0.5 watt

$R_{10} = 39 \text{ ohms} \pm 10\%$ , 0.5 watt

$R_{11} = 10000 \text{ ohms} \pm 10\%$ , 0.5 watt

$R_{13} = 680 \text{ ohms} \pm 10\%$ , 0.5 watt

S = toggle switch; single-pole, single-throw  
 $T_1 =$  transformer; 117-v. primary; 25.6 v, 0.6-amp. secondary; Thordarson T-21F27, or equiv.

$T_2 =$  transformer, 117-v. primary; 6.3 v, 0.6-amp. secondary; Sencor P-6465, or equiv.

## 11-41

## ELECTRONIC KEYER

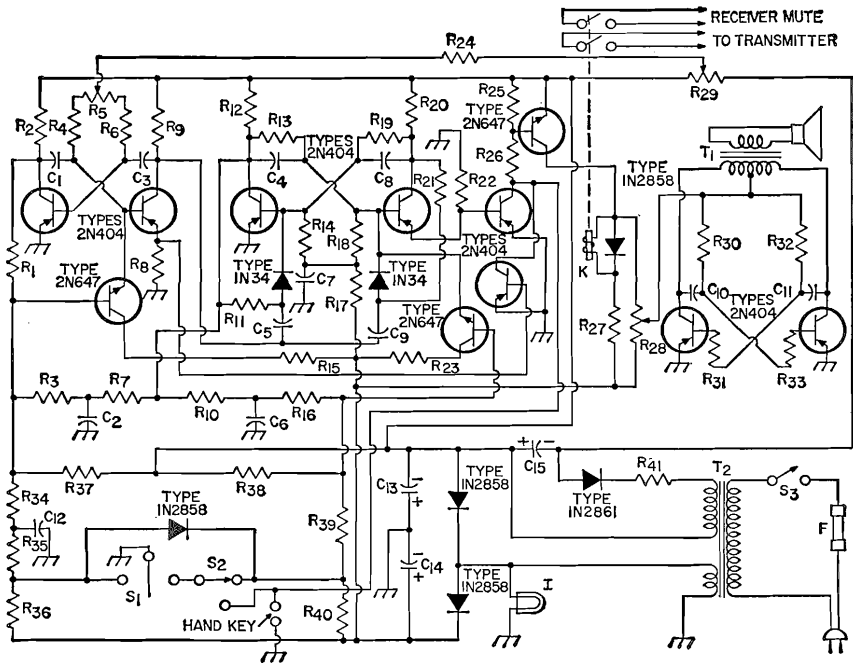

$C_1, C_3 = 1 \mu\text{f}$ , paper (or Mylar), 200 v.  
 $C_2 = 0.47 \mu\text{f}$ , ceramic, 25 v.  
 $C_4, C_9 = 560 \text{ pf}$ , ceramic, 600 v.  
 $C_6, C_9 = 330 \text{ pf}$ , ceramic, 600 v.  
 $C_8, C_7 = 0.01 \mu\text{f}$ , ceramic, 50 v.  
 $C_{10}, C_{11} = 0.02 \mu\text{f}$ , ceramic, 50 v.  
 $C_{12} = 0.1 \mu\text{f}$ , ceramic, 50 v.  
 $C_{13}, C_{14} = 2000 \mu\text{f}$ , electrolytic, 15 v.  
 $C_{15} = 16 \mu\text{f}$ , electrolytic, 150 v.  
 I = indicator lamp No. 47  
 K = dc relay; coil resistance = 2500 ohms; operating current = 4 ma; Potter-Brumfield ML11D, or equiv.  
 $R_1 = 39000 \text{ ohms}$ , 0.5 watt

$R_2, R_9, R_{12}, R_{20} = 3900 \text{ ohms}$ , 0.5 watt  
 $R_3, R_{16} = 18000 \text{ ohms}$ , 0.5 watt  
 $R_4, R_8 = 51000 \text{ ohms}$ , 0.5 watt  
 $R_6, R_{29} = \text{potentiometer}$ , 10000 ohms  
 $R_7, R_{10} = 22000 \text{ ohms}$ , 0.5 watt  
 $R_8, R_{22}, R_{26} = 68 \text{ ohms}$ , 0.5 watt  
 $R_{11}, R_{23} = 15000 \text{ ohms}$ , 0.5 watt  
 $R_{13}, R_{19} = 33000 \text{ ohms}$ , 0.5 watt  
 $R_{14}, R_{18}, R_{20}, R_{22} = 27000 \text{ ohms}$ , 0.5 watt  
 $R_{15}, R_{28} = 270 \text{ ohms}$ , 0.5 watt  
 $R_{17} = 68000 \text{ ohms}$ , 0.5 watt  
 $R_{24} = 100000 \text{ ohms}$ , 0.5 watt  
 $R_{26} = 560 \text{ ohms}$ , 0.5 watt  
 $R_{27} = 1200 \text{ ohms}$ , 0.5 watt

$R_{28} = \text{volume-control potentiometer}$ , 50000 ohms  
 $R_{31}, R_{33} = 10000 \text{ ohms}$ , 0.5 watt  
 $R_{34} = 6800 \text{ ohms}$ , 0.5 watt  
 $R_{35} = 8200 \text{ ohms}$ , 0.5 watt  
 $R_{36}, R_{39}, R_{40} = 15000 \text{ ohms}$ , 0.5 watt  
 $R_{37}, R_{38} = 47000 \text{ ohms}$ , 0.5 watt  
 $R_{41} = 10000 \text{ ohms}$ , 1 watt  
 $S_1 = \text{Vibroplex keyer}$ , or equiv.  
 $S_2 = \text{toggle switch}$ , double-pole, double-throw  
 $S_3 = \text{toggle switch}$ ; single-pole, single-throw  
 $T_1 = \text{push-pull output transformer}$  (14000 ohm to V.C.)  
 $T_2 = \text{power transformer}$ , Stancor PS8415, PS8421, or equiv.

11-42

GRID-DIP METER

For Measuring Resonant Frequencies from 3.5 to 100 Mc

- B = 13.5 volts, RCA VS304
- C<sub>1</sub> = 33 μμf, mica, 50 v.
- C<sub>2</sub> = 0.01 μf, paper, 50 v.
- C<sub>3</sub> = 5 μμf, mica, 50 v.
- C<sub>4</sub> = 0.01 μf, paper, 50 v.
- C<sub>5</sub> = variable capacitor, 50 pf (Hammarlund type HF-50 or equivalent)
- J = phone jack, normally closed
- L = plug-in coil
- M = microammeter, 0 to 50 μa (Simpson model 1227 or equivalent)
- R<sub>1</sub> = variable resistor, 0-0.25 megohm, 0.5 watt
- R<sub>2</sub> = 220 ohms, 0.5 watt
- R<sub>3</sub> = 3,000 ohms, 0.5 watt
- R<sub>4</sub> = 3,900 ohms, 0.5 watt
- R<sub>5</sub> = 39,000 ohms, 0.5 watt
- X = jumper, omit for measurements below 45 Mc

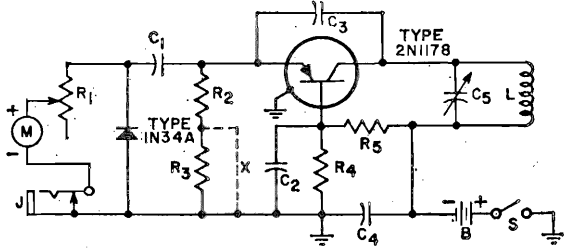

NOTE: Wind coils according to the following directions:

Coil Freq. Range	Wire Size	No. of Turns
1 3.4-6.9 Mc	#28, enamel	48 1/4, close wound
2 6.7-13.5 Mc	#24, enamel	22, close wound
3 13-27 Mc	#24, enamel	9 1/8, close wound
4 25-47 Mc	#24, enamel	4 1/8, close wound
5 46-78 Mc	#24, enamel	1 1/2, close wound
6 74-97 Mc	#16, tinned	hairpin formed, 1 7/8 inches long including pins, and 1/4 inch wide

Coil forms are Amphenol type 24-5H or equivalent.

11-43

LIGHT FLASHER

60 Flashes per Minute

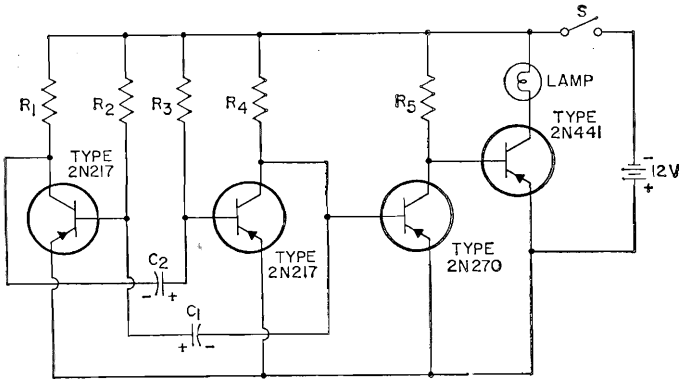

- C<sub>1</sub> = 25 μf, electrolytic, 12 v.
- C<sub>2</sub> = 100 μf, electrolytic, 12 v.
- LAMP = bulb, 12 v, 1 ampere
- R<sub>1</sub> R<sub>4</sub> = 2000 ohms, 0.5 watt
- R<sub>2</sub> R<sub>3</sub> = 100000 ohms, 0.5 watt

- R<sub>5</sub> = 120 ohms, 0.5 watt
- S = switch

NOTE: C<sub>1</sub> and C<sub>2</sub> may be varied to change flashing

rate. Bulbs and other resistive loads handling currents up to one ampere may be used, but inductive loads should not be used.

### 11-44 LIGHT DIMMER CONTROL USING SILICON CONTROLLED RECTIFIER (Half wave)

C = 0.47  $\mu$ f, paper, 200 v.  
L = incandescent lamp, 300 watts maximum  
R<sub>1</sub> = 25000 ohms, 2 watts  
R<sub>2</sub> = 1000 ohms, 1 watt

\* With the 1N1614 rectifier in the circuit (switch closed), light control is extended from 0 to 30 per cent of full brightness to 0 to 100 per cent of full brightness.

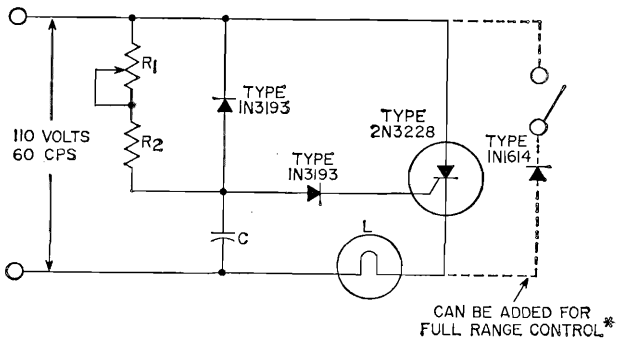

### 11-45 CODE-PRACTICE OSCILLATOR

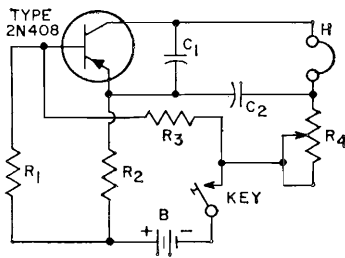

B = 1.5-4.5 v. (One to three series-connected RCA VS036 dry cells may be used, depending upon the volume level desired.)  
C<sub>1</sub> C<sub>2</sub> = 0.01  $\mu$ f, paper, 150 v.  
H = Headphone, 2000-ohm, magnetic  
R<sub>1</sub> = 2200 ohms, 0.5 watt  
R<sub>2</sub> = 27000 ohms, 0.5 watt  
R<sub>3</sub> = 3000 ohms, 0.5 watt  
R<sub>4</sub> = volume control potentiometer, 50000 ohms, 0.5 watt

### 11-46 PHOTO-RELAY Operates with Light Increase

B = 6 volts, RCA VS317  
R<sub>1</sub> = 120 ohms, 0.5 watt  
R<sub>2</sub> = potentiometer, 5000 ohms; Mallory U-14 or equivalent  
Relay = 1000 ohms, 2.3-milliampere operating current; Sigma type 5F or equivalent

NOTE: The relay mounting frame is at armature potential and should be insulated from a common chassis for safety reasons.

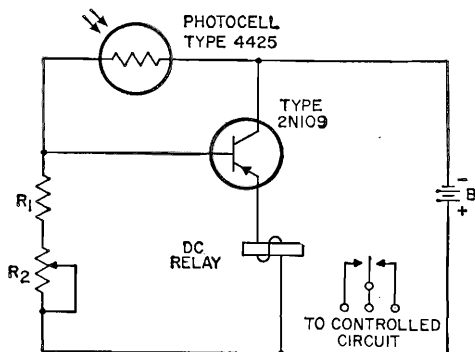

# RCA Technical Publications

## *on Electron Tubes, Semiconductor Products, and Batteries*

Copies of the publications listed below may be obtained from your RCA distributor or from Commercial Engineering, Radio Corporation of America, Harrison, N. J.

### Semiconductor Products

- **RCA SEMICONDUCTOR PRODUCTS HANDBOOK—HB-10.** Two binders, each 7 $\frac{3}{8}$ " L x 5 $\frac{5}{8}$ " W x 2 $\frac{7}{8}$ " D. Contains over 1000 pages of loose-leaf data and curves on RCA semiconductor devices such as transistors, silicon rectifiers, and semiconductor diodes. Available on a subscription basis. Price \$10.00\* including service for first year. Also available with RCA Electron Tube Handbook HB-3 at special combination price of \$25.00.\*
- **RCA TUNNEL DIODE MANUAL—TD-30** (8 $\frac{3}{8}$ " x 5 $\frac{5}{8}$ ")—160 pages. Describes the microwave and switching capabilities of tunnel diodes. Contains information on theory and characteristics, and on tunnel-diode applications in switching circuits and in microwave oscillator, converter, and amplifier circuits. Includes data for over 40 RCA germanium and gallium arsenide tunnel diodes and tunnel rectifiers. Price \$1.50.\*†
- **RCA SEMICONDUCTOR PRODUCTS GUIDE—3L1010/1L1147** (10 $\frac{7}{8}$ " x 8 $\frac{3}{8}$ ")—12 pages. Contains classification chart, index, and ratings and characteristics on RCA's line of transistors, silicon rectifiers, semiconductor diodes, and photocells. Single copy free on request.
- **RCA SILICON POWER TRANSISTORS APPLICATION GUIDE—1CE-215** (10 $\frac{7}{8}$ " x 8 $\frac{3}{8}$ ")—28 pages. Describes outstanding features of RCA silicon power transistors and their use in many critical industrial and military applications. Includes construction details, discussion of voltage ratings, thermal stability conditions, and equivalent circuits for power transistors. Price 50 cents.\*†
- **TRANSISTORIZED VOLTAGE REGULATORS APPLICATION GUIDE—1CE-254** (10 $\frac{7}{8}$ " x 8 $\frac{3}{8}$ ")—12 pages. Describes and discusses transistorized voltage regulators of the series and shunt types. Included are design considerations, step-by-step design procedures, and the solutions to sample design problems. An Appendix contains the derivation of design equations. Price 25 cents.\*†
- **RCA TRANSISTOR REPLACEMENT GUIDE—1L1115** (10 $\frac{7}{8}$ " x 8 $\frac{3}{8}$ ")—36 pages. Contains RCA transistor and rectifier replacement data for more than 1000 portable radio receivers, table radio receivers, tape recorders, and portable equipment of 145 manufacturers. Price 35 cents.\*†
- **RCA SILICON RECTIFIER INTERCHANGEABILITY DIRECTORY—1CE-229A** (10 $\frac{7}{8}$ " x 8 $\frac{3}{8}$ ")—16 pages. Contains replacement information, ratings, characteristics, and physical dimensions for more than 400 silicon and selenium rectifiers. Price 25 cents.\*†
- **RCA VARACTORS—VAR-100** (10 $\frac{7}{8}$ " x 8 $\frac{3}{8}$ ")—8 pages. Contains complete data on RCA's line of silicon and gallium arsenide varactors. Quick-selection guide permits easy selection of proper RCA varactor for given frequency-multiplier or parametric-



amplifier application. Single copy free on request

● **TECHNICAL BULLETINS**—Authorized information on RCA semiconductor products. Be sure to mention type-number bulletin desired. Single copy on any type free on request.

## Electron Tubes

● **RCA ELECTRON TUBE HANDBOOK**—HB-3 (7 $\frac{3}{8}$ " x 5 $\frac{5}{8}$ "). Five 2 $\frac{1}{4}$ -inch-capacity binders. Contains over 5000 pages of looseleaf data and curves on RCA receiving tubes, transmitting tubes, cathode-ray tubes, picture tubes, photocells, phototubes, camera tubes, ignitrons, vacuum gas rectifiers, traveling-wave tubes, premium tubes, pencil tubes, and other miscellaneous types for special applications. Available on subscription basis. Price \$20.00\* including service for first year. Also available with RCA Semiconductor Products Handbook HB-10 at special combination price of \$25.00.\*

● **RADIOTRON° DESIGNER'S HANDBOOK**—4th Edition (8 $\frac{3}{4}$ " x 5 $\frac{1}{2}$ ")—1500 pages. Comprehensive reference covering the design of radio and audio circuits and equipment. Written for the design engineer, student, and experimenter. Contains 1000 illustrations, 2500 references, and cross-referenced index of 7000 entries. Edited by F. Langford-Smith.

● **RCA PHOTOTUBE AND PHOTOCCELL MANUAL**—PT-60 (8 $\frac{1}{4}$ " x 5 $\frac{3}{8}$ ")—192 pages. Well-illustrated informative manual covering fundamentals and operating considerations for vacuum and gas phototubes, multiplier phototubes, and photocells. Also describes basic applications for these devices. Features easy-to-use selection chart for multiplier phototubes. Data and performance curves given for over 90 photo-sensitive devices. Price \$1.50\*†

● **RCA RECEIVING TUBE MANUAL**—RC-22 (8 $\frac{1}{4}$ " x 5 $\frac{3}{8}$ ")—544 pages. Contains technical data on over 1000 receiving-type tubes for home-entertainment use and picture tubes for

black-and-white and color TV. Features tube theory written for the layman, application data, selection charts, and typical circuits. Features lie-flat binding. Price \$1.25\*†

● **RCA TRANSMITTING TUBES**—TT-5 (8 $\frac{1}{4}$ " x 5 $\frac{3}{8}$ ")—320 pages. Gives data on over 180 power tubes having plate-input ratings up to 4 kw and on associated rectifier tubes. Provides basic information on generic types, parts and materials, installation and application, and interpretation of data. Contains circuit diagrams for transmitting and industrial applications. Features lie-flat binding. Price \$1.00\*†

● **RCA POWER TUBES**—PG101F (10 $\frac{7}{8}$ " x 8 $\frac{3}{8}$ ")—36 pages. Technical information on 200 RCA vacuum power tubes, rectifier tubes, thyratrons, and ignitrons. Includes terminal connections. Price 60 cents.\*†

● **RCA RECEIVING-TYPE TUBES FOR INDUSTRY AND COMMUNICATIONS**—RIT 104C (10 $\frac{7}{8}$ " x 8 $\frac{3}{8}$ ")—44 pages. Technical information on over 190 RCA "special red" tubes, premium tubes, nuvistors, computer tubes, pencil tubes, glow-discharge tubes, small thyratrons, low-microphonic amplifier tubes, mobile communications tubes, and other special types. Includes socket-connection diagrams. Price 35 cents.\*†

● **RCA RECEIVING TUBES AND PICTURE TUBES**—1275K (10 $\frac{7}{8}$ " x 8 $\frac{3}{8}$ ")—64 pages. New, enlarged, and up-to-date booklet contains classification chart, application guide, characteristics chart, and base and envelope connection diagrams on more than 1050 entertainment receiving tubes and picture tubes. Price 50 cents.\*†

● **RCA PHOTO AND IMAGE TUBES**—1CE-269 (10 $\frac{7}{8}$ " x 8 $\frac{3}{8}$ ")—32 pages. Includes concise data on RCA multiplier phototubes, gas and vacuum photo-diodes, and image-converter tubes. Contains response curves for photo and image tubes, sockets and shields for phototubes, and dimensional outlines for photo and image tubes. Price 60 cents.\*†

● **RCA INTERCHANGEABILITY DIRECTORY OF INDUSTRIAL-TYPE ELECTRON TUBES—ID-1020D** (10 $\frac{7}{8}$ " x 8 $\frac{3}{4}$ ")—12 pages. Lists more than 1600 basic type designations for 20 classes of industrial tube types; shows the RCA Direct Replacement Type or the RCA Similar Type, when available. Price 35 cents.\*†

● **RCA PHOTOCELLS—ICE-261A** (10 $\frac{7}{8}$ " x 8 $\frac{3}{8}$ ")—32 pages. Contains a selection of photocell-circuit diagrams; technical data and characteristic curves of RCA photoconductive, photojunction, and photovoltaic cells; interchangeability information. Also contains 22 representative circuits. Price 50 cents.\*†

● **RCA MAGNETRONS AND TRAVELING-WAVE TUBES—MT-301A** (10 $\frac{7}{8}$ " x 8 $\frac{3}{8}$ ")—48 pages. Operating theory for magnetrons and traveling-wave tubes, application considerations, and techniques for measurement of electrical parameters. Price 60 cents.\*†

● **RCA PENCIL TUBES—ICE-219** (10 $\frac{7}{8}$ " x 8 $\frac{3}{8}$ ")—28 pages. Contains operating theory for pencil tubes, electrical and mechanical circuit-design considerations, environmental considerations, application considerations, and data for commercial types. Price 50 cents.\*†

● **RCA CAMERA TUBES—CAM-600** (10 $\frac{7}{8}$ " x 8 $\frac{3}{8}$ ")—16 pages. Contains classification charts, defining data and typical characteristics curves for RCA image orthicons and vidicons. Camera tubes recommended for new equipment design are highlighted. Price 50 cents.\*†

● **RCA INTERCHANGEABILITY DIRECTORY OF FOREIGN vs. U.S.A. RECEIVING-TYPE ELECTRON TUBES—ICE-197C** (8 $\frac{3}{8}$ " x 10 $\frac{7}{8}$ ")—8 pages. Covers approximately 800 AM and FM radios used principally in AM and FM radios, TV receivers, and audio amplifiers. Indicates U.S.A. direct replacement type or similar type if available. Price 10 cents.\*

● **RCA STORAGE AND CATHODE-RAY TUBES—ICE-270** (10 $\frac{7}{8}$ " x 8 $\frac{3}{8}$ ")—12 pages. Includes concise data on RCA display-storage tubes, computer-storage tubes, scan-converters, radechons, oscillograph-type cathode-ray tubes, and special purpose kinescopes. Price 20 cents.\*†

● **RCA NUVISTOR TUBES FOR INDUSTRIAL AND MILITARY APPLICATIONS—ICE-280** (10 $\frac{7}{8}$ " x 3 $\frac{3}{8}$ ")—16 pages. Describes unique features of nuvistors and includes tabular data, dimensional outlines, curves, terminal diagrams, and socket information. Price 25 cents.\*†

● **TECHNICAL BULLETINS**—Authorized information on RCA receiving tubes, transmitting tubes, and other tubes for communications and industry. Be sure to mention tube-type bulletin desired. Single-copy on any type free on request.

## Batteries

● **RCA BATTERY MANUAL—BDG-111** (10 $\frac{7}{8}$ " x 8 $\frac{3}{4}$ ")—64 pages. Contains information on dry cells and batteries [carbon zinc (Leclanché), mercury, and alkaline types]. Includes battery theory and applications, detailed electrical and mechanical characteristics, a classification chart, dimensional outlines, and terminal connections on each battery type. Price 50 cents.\*†

● **RCA BATTERIES—BAT-134F** (10 $\frac{7}{8}$ " x 8 $\frac{3}{8}$ ")—24 pages. Technical data on 113 Leclanché, alkaline, and mercury-type dry batteries for radios, industrial applications, flashlights, lanterns, and for photoflash service. Price 35 cents.\*†

---

° Trade Mark Reg. U.S. Pat. Off.

\* Prices shown apply in U.S.A. and are subject to change without notice.

† Suggested price.

## Reading List

The following list contains a number of references which should prove helpful to those interested in further information on semiconductor theory and applications.

- Basic Theory and Application of Transistors* TM 11-690, U.S. Govt. Printing Office, 1959.
- BETRIDGE, B. R. *Transistors and Crystal Diodes*, Wehman Bros., 1954.
- BIONDI, S. J. *Transistor Technology*, Vol. III. D. Van Nostrand Co., Inc., 1958.
- CALDWELL, W. C. *Practical Transistor Servicing*, Howard W. Sams Co., Inc., 1960.
- CARROLL, J. M. *Transistor Circuits and Applications*, McGraw-Hill Book Co., Inc., 1957.
- CONTI, T. *Metallic Rectifiers and Crystal Diodes*, John F. Rider, Inc., 1958.
- DUNLAP, W. C. *Introduction to Semiconductors*, John Wiley and Sons, Inc., 1957.
- EVANS, J. *Fundamental Principles of Transistors*, D. Van Nostrand Company, Inc., 1958.
- GREINER, R. A. *Semiconductor Devices and Applications*, McGraw-Hill Book Co., Inc., 1961.
- JOYCE, M. V. *Transistor Circuit Analysis*, Addison Wesley Co., Inc., 1961.
- HUNTER, L. P. *Handbook of Semiconductor Electronics*, McGraw-Hill Book Co., Inc., 1958.
- LEHRMAN, H. *Transistor Techniques*, Gernsback Library, Inc., 1957.
- LINVILL, J. G. *Transistors and Active Circuits*, McGraw-Hill, Inc., 1961.
- LO, A. W., et al. *Transistor Electronics*, Prentice-Hall, Inc., 1955.
- LURCH, J. *Fundamentals of Electronics*, John Wiley and Sons, Inc., 1960.
- MILLMAN, J. *Vacuum Tube and Semiconductor Electronics*, McGraw-Hill Book Co., Inc., 1958.
- MUELLER, H. *Introduction to Electrical Engineering*, McGraw-Hill Book Co., Inc., 1957.
- PRESSMAN, A. I. *Design of Transistorized Circuits for Digital Computers*, John F. Rider, Inc., 1959.
- PULLEN, K. A. *Handbook of Transistor Design*, Prentice-Hall, Inc., 1961.
- RYDER, J. *Electronic Fundamentals and Applications*, Prentice-Hall, Inc., 1959.
- SEELY, J. *Radio Electronics*, McGraw-Hill Book Co., Inc., 1956.
- SHEA, R. F. *Transistor Circuit Engineering*, John Wiley and Sons, Inc., 1957.
- SHOCKLEY, W. *Electrons and Holes in Semiconductors*, D. Van Nostrand Co., 1950.
- SHURE, A. *Semiconductors and Transistors*, John F. Rider, Inc., 1961.
- TERMAN, F. E. *Electronics and Radio Engineering*, McGraw-Hill Book Co., Inc., 1955.
- TURNER, R. P. *Transistor Circuits*, Gernsback Library, Inc., 1957.

# Index

	Page		Page
<b>A</b> bsolute Maximum System of Ratings	79	DC-to-DC Converter	366
Alloy-Junction Transistors	10	Earphone Amplifier	353
Alpha Characteristic	15	Eccles-Jordan Multivibrator	46
AM/FM Automobile Radio Circuit	347	Electronic Keyer	375
Amplification	24	Electronic Thermostat	374
Amplifiers:		Filter	46
Audio	24	Flipflop	45
Class A	24	FM Stereo Multiplex Adapter	355
Class AB	24	“Front End” for Radio Receiv-	
Class B	24	ers	351, 362
Class C	24	Gating Circuits	47
Differential	36	Grid-Dip Meter	376
Direct-Coupled	35	IF Amplifier (30-Mc)	363
Intermediate-Frequency	30	Ignition System:	
Neutralized	32	6-volt	371
Phase Inverter	30	12-volt	371
Power	26	Light-Dimmer Control	377
Push-Pull	28	Light-Flasher	376
Radio-Frequency	30	Logic	47
Tuned	30	Monostable	46
Unilateralized	32	Motor-Speed Control	376
Anode	8	NAND	48
Astable Circuits	45	NOR	47
Astable Multivibrator Circuit	45, 46	OR	47
Audio Amplifiers	24	Phonograph Amplifier	353
Audio Amplifier Circuit (25 watt)	354	Photo-Relay	377
Audio-Power Amplifiers	26	Portable Radio Receivers	344, 345
Automatic Gain Control	33	Power Amplifier, 70-Mc	361
Automobile Radio Circuit:		Power Oscillator:	
6-volt	346	100-Kc	364
12-volt	347	70-Mc	365
Avalanche Voltage	50	Power Supply For Amateur	
		Transmitter	358
<b>B</b> arrier, Energy	6	Preamplifier	352
Beta Characteristic	15	Radio Receiver, 3-band	350
Biasing	6, 18	Regulator:	
Bistable Circuits	45	Series	35
Bistable Multivibrator Circuit	45, 46	Shunt	35
Blocking Oscillator	43	Resonant	30
Breakdown Voltage	16, 50	Servo Amplifier	364
Bridge Circuits:		Single-Phase Full-Wave	54
Single-Phase Full-Wave	54	Single-Phase Full-Wave Bridge	55
Three-Phase (Y) Half-Wave	55	Single-Phase Half-Wave	54
		Six-Phase Star	56
<b>C</b> alculation of,		Shift Register	373
Heat-Sink Size	51	Stereo Amplifiers	356, 357
“Q” (selectivity)	31	Three-Phase Double-Y and	
Transistor Dissipation	79	Interphase Transformer	55
Capacitive Division	34	Three-Phase (Y) Half-Wave	55
Characteristics:	81	Triggered	46
Alpha	15	Video Amplifier	361
Beta	15	Voltage Regulator, Shunt Type:	
Dynamic	15	Regulation = 0.5%	367
Static	15	Regulation = 1.5%	368
Chopper-Type Circuits	36	Voltage Regulator, Series Type:	
Circuits:		Adjustable Regulation	368
AM/FM Automobile Radio	348	Regulation = 2%	367
AND	47	Voltage-Sensitive Switches	372
Astable Multivibrator	45, 369	Circuit Configurations	11
Audio Amplifier (25-watt)	354	Circuit Stability	23
Automobile Radio, 6-volt	346	Clapp Oscillator	40
Automobile Radio, 12-volt	347	Class A Amplifier	24
Bistable Multivibrator	45, 370	Class AB Amplifier	24
Chopper-Type	36	Class B Amplifier	24
Citizens-Band Transceiver	359	Class C Amplifier	24
Citizens-Band Transmitter	360	Code-Practice Oscillator (Circuit)	378
Code-Practice Oscillator	377	Collector-Characteristic Curve	14
Crystal Oscillator, 27-Mc	365	Colpitts Oscillator	40
		Compensating Diodes	74
		Complementary Symmetry	30
		Controls, Tone and Volume	26

	<i>Page</i>		<i>Page</i>
Coupling	21	Grid-Dip Meter (Circuit)	376
Cross-Modulation	34	Grown-Junction Transistor	10
Cross-Over Distortion	28	<b>H</b> alf-Wave Single-Phase Circuit	54
Crystal Oscillator	40	Hartley Oscillator	40
Crystal Oscillator Circuit (27-Mc)	365	Heat Sinks	51, 77
Current:		High-Current Tunnel Diodes	72
Cutoff	16	<b>I</b> dling Current	20
Fault	50	Impedance Coupling	22
Flow	6	Impurities	4
Idling	20	Input Filters	56
Maximum Average Forward	50	Installation, Transistor	76
Maximum Surge	50	Intermediate-Frequency Amplifiers	30
Peak Recurrent Forward	50	Inverse Feedback	25
Cutoff, Frequency	15	Inverter, Phase	30
Cutoff, Current	16	<b>J</b> unctions	3
<b>D</b> ata, Interpretation of	79	Junction Transistors	10
Degenerative Feedback	25	<b>L</b> C Resonant Feedback Oscillator	37
Delay Time ( $t_d$ )	45	Leakage Currents	16
Depletion Layer	5	Letter Symbols, Transistor	81
Differential Amplifiers	36	Light-Flasher (Circuit)	376
Diffused Transistors	11	Logic Circuits	47
Diodes:		<b>M</b> aterials, Junctions, and Devices	3
Compensating	74	Mesa Transistor	11
Tunnel	68	Monostable Circuits	46
Varactor	73	Multivibrator	43
Voltage-Reference	74	<b>N</b> AND Circuits	48
Direct-Coupled Amplifiers	35	Negative Feedback	25
Direct Coupling	23	Negative-Resistance Characteristic	69
Dissipation, Transistor	79	Neutralized Amplifiers	32
Distortion, Crossover	28	Noise Figure	24
Division, Capacitive	34	Nonsinusoidal Oscillators	42
Dress of Circuit Leads	78	NOR Circuits	47
Drift-Field Transistor	10	N-P-N Structures	7
Drivers	26	N-type Material	5
Dynamic Characteristics	14	<b>O</b> R Circuits	47
<b>E</b> ccler-Jordan Multivibrator Circuit	46	Oscillation	36
Electrical Connections	76	Oscillators:	
Electron Flow	5	Blocking	43
Emitter	8	Clapp	40
Energy Barrier	6	Colpitts	40
Epitaxial Mesa Transistor	11	Crystal	40
Extrinsic Transconductance	15	Hartley	40
<b>F</b> all Time ( $t_f$ )	45	LC Resonant Feedback	37
Fault Current	50	Nonsinusoidal	42
Feedback	25	Pierce	41
Figure-of-Merit	70	RC Resonant Feedback	41
Filters	78	Wien	42
Fixed Bias	18	Outlines	332
Flipflop Circuit	45	Overload Protection	53, 62
FM Stereo Multiplex Adapter (Circuit)	355	<b>P</b> arallel Arrangement	52
Forward Bias	6	Parametric Diode	8
Forward Characteristics, Silicon		Peak Recurrent Forward Current	50
Rectifier	50	Peak Reverse Voltage	50
Forward Current-Transfer Ratio	15	Phase Inverter	30
Frequency Compensation	25	Phonograph Amplifier (Circuit)	353
Frequency Cutoff	15	Photo-Relay Circuit	377
"Front End" for Radio Receivers			
(Circuits)	351, 362		
<b>G</b> ain-Bandwidth Product	15		
Gain, Automatic Control	33		
Gating Circuits	47		

	Page		Page
Planar Transistor .....	11	Sustaining Voltage .....	16
P-N Junction .....	5	Switching .....	44
P-N-P Structures .....	7	Switching Times .....	44
Point-Contact Transistors .....	10	Symbols, Transistor .....	81
Portable Radio Receivers (Circuit) 344, 345		Symmetry, Complementary .....	30
Positive Feedback .....	10	<b>T</b> echnical Data .....	87
Power Amplifier, Audio (Class A) .....	24	Temperature Effects .....	76
Power Amplifier Circuit (70-Mc) .....	361	Testing .....	3
Power Oscillator Circuits:		Thermal Considerations .....	49
100-Kc .....	364	Thermal Runaway .....	49
70-Mc .....	365	Thermistor Bias .....	20
Power Supply for Amateur Transmitter (Circuit) .....	358	Three-Phase (Double-Y) and Inter- phase Transformer Circuit .....	55
Preamplifiers .....	24, 352	Three-Phase (Y) Half-Wave Circuit .....	55
P-Type Material .....	5	Thyristor .....	59
Pulse Time ( $t_p$ ) .....	45	Tone Controls .....	26
Punch-Through Voltage .....	17	Transconductance, Extrinsic .....	15
Push-Pull Amplifiers .....	28	Transfer-Characteristic Curves .....	14
<b>"Q"</b> (Selectivity), Calculation of ...	31	Transformer Coupling .....	21
<b>R</b> adiation Considerations .....	72	Transistor:	
Radio-Frequency Amplifiers .....	30	Applications .....	18
Radio Receiver, 3-Band (Circuit) .....	350	Characteristics .....	14
Reach-Through Voltage .....	17	Design and Circuit Configurations .....	10
Rectifiers:		Common-Base .....	11
Silicon .....	49	Common-Collector .....	13
Tunnel .....	72	Common-Emitter .....	12
Regenerative Feedback .....	25	Dissipation .....	79
Region, Transition .....	5	Installation .....	76
Regulator Circuits:		Symbols .....	81
Series .....	35	Types:	
Shunt .....	35	Alloy-Junction .....	10
Resistance-Capacitance Coupling .....	22	Drift-Field .....	10
Resistivity .....	3	Epitaxial Mesa .....	11
Resonant Circuits .....	30	Grown-Junction .....	10
Reverse Bias .....	6	Mesa .....	11
Ripple .....	53	Planar .....	11
Rise Time ( $t_r$ ) .....	45	Point-Contact .....	10
<b>S</b> aturation Transconductance .....	15	Transition Region .....	5
Saturation Voltage .....	17	Triggered Circuits .....	45
Second Breakdown .....	16	Tuned Amplifiers .....	30
Selection Charts .....	82	Tunnel Diodes .....	68
Series Arrangement .....	52, 62	Tunnel Rectifiers .....	72
Series Regulator Circuits .....	35	Turn-On Time .....	45
Servo Amplifier Circuit .....	364	Turn-Off Time .....	45
Shielding .....	77	<b>U</b> nilateralized Amplifier .....	32
Shunt Regulator Circuits .....	35	<b>V</b> aractor Diodes .....	73
Signal-to-Noise Ratio .....	24	Video Amplifier Circuit .....	361
Silicon Controlled Rectifiers		Voltage:	
Characteristics .....	60	Avalanche .....	50
Construction .....	59	Breakdown .....	16, 50
Current Ratios .....	64	Peak Reverse .....	50
Overload Protection .....	62	Punch-through .....	17
Power Control .....	63	Reach-through .....	17
Ratings .....	61	Saturation .....	17
Series Arrangement .....	62	Sustaining .....	16
Triggering Characteristics .....	61	Zener .....	49
Silicon Rectifiers .....	49	Voltage-Reference Diodes .....	74
Single-Phase Full-Wave Bridge Circuit .....	55	Voltage Regulator, Shunt Type (Circuit):	
Single-Phase Full-Wave Circuit .....	54	Regulation = 0.5% .....	367
Six-Phase Star Circuit .....	56	Regulation = 1.5% .....	367
Static Characteristics .....	15	Voltage Regulator, Series Type (Circuit):	
Stereo Amplifier Circuits .....	356, 357	Adjustable Regulation .....	368
Storage Time ( $t_s$ ) .....	45	Regulation = 2% .....	367
Stored Base Charge .....	17	Volume Controls .....	26
Structures:		<b>Z</b> ener Voltage .....	49
N-P-N .....	7		
P-N-P .....	7		
Surge Current, Maximum .....	50		

## KEY TO TERMINAL DIAGRAMS

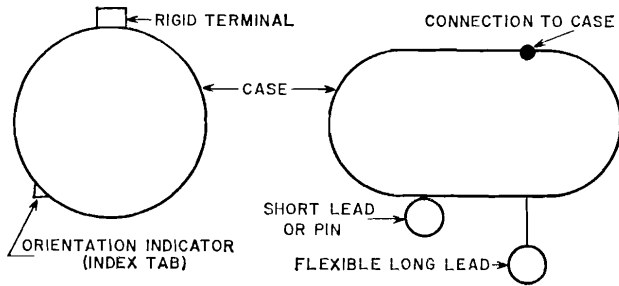

A	Anode	F	Mounting Flange
B	Base	G	Gate
C	Collector	IC	Internal Connection
D <sub>1</sub>	Diode Unit No. 1	IS	Interlead Shield
D <sub>2</sub>	Diode Unit No. 2	K	Cathode
D <sub>3</sub>	Diode Unit No. 3	L	Lug
E	Emitter	S	Stud

### NOTES:

Elongated case symbol denotes "in-line" arrangement of electrode terminals.

Arrow on case of diodes or emitter lead of transistor diagrams indicates direction of "conventional current flow"; electron current flows in a direction opposite to the arrows.



# RCA TRANSISTOR MANUAL

Revised and up-dated for the reader who wants to be informed of the latest changes in semiconductor-device technology and data. Features over 200 additions to RCA's extensive line of semiconductor products. The popular Circuits Section has also been revised to include several new interesting and practical circuit applications.

## NEW FEATURES

- Complete chapter on silicon controlled rectifiers discussing basic operation and applications.
- Revised application guide specifying recommended usage for RCA transistors.
- Additions to the expanded Technical Data Section include varactor diodes, silicon controlled rectifiers, high-voltage rectifiers, tunnel diodes, and many new types of transistors.
- **AND, for the experimenter and hobbyist**, several new circuits including two portable radio receivers, a variety of hi-fi and stereo components, a five-watt citizens-band transmitter, ignition systems, electronic control circuits, and many other popular applications.

TECHNICAL SERIES SC-11

